

VSI OpenVMS

VSI Pascal for OpenVMS Reference Manual

Document Number: DO-DPASRF-01A

Publication Date: March 2022

This manual contains the complete description of the VSI Pascal for OpenVMS programming language.

Revision Update Information: This is a new manual.

Operating System and Version: VSI OpenVMS I64 Version 8.4-1H1
VSI OpenVMS Alpha Version 8.4-2L1

Software Version: VSI Pascal Version 6.2 for OpenVMS I64
VSI Pascal Version 6.2-125 for OpenVMS Alpha

VSI Pascal for OpenVMS Reference Manual



Copyright © 2022 VMS Software, Inc. (VSI), Burlington, Massachusetts, USA

Legal Notice

Confidential computer software. Valid license from VSI required for possession, use or copying. Consistent with FAR 12.211 and 12.212, Commercial Computer Software, Computer Software Documentation, and Technical Data for Commercial Items are licensed to the U.S. Government under vendor's standard commercial license.

The information contained herein is subject to change without notice. The only warranties for VSI products and services are set forth in the express warranty statements accompanying such products and services. Nothing herein should be construed as constituting an additional warranty. VSI shall not be liable for technical or editorial errors or omissions contained herein.

HPE, HPE Integrity, HPE Alpha, and HPE Proliant are trademarks or registered trademarks of Hewlett Packard Enterprise.

Intel, Itanium and IA64 are trademarks or registered trademarks of Intel Corporation or its subsidiaries in the United States and other countries.

Java, the coffee cup logo, and all Java based marks are trademarks or registered trademarks of Oracle Corporation in the United States or other countries.

Kerberos is a trademark of the Massachusetts Institute of Technology.

Microsoft, Windows, Windows-NT and Microsoft XP are U.S. registered trademarks of Microsoft Corporation. Microsoft Vista is either a registered trademark or trademark of Microsoft Corporation in the United States and/or other countries.

Motif is a registered trademark of The Open Group

UNIX is a registered trademark of The Open Group.

Preface	xi
1. Intended Audience	xi
2. Document Structure	xi
3. Related Documents	xii
4. VSI Encourages Your Comments	xii
5. OpenVMS Documentation	xii
6. Conventions	xii
Chapter 1. Language Elements	1
1.1. Pascal Language Standards	1
1.1.1. Unextended Pascal Standards	1
1.1.2. Extended Pascal Standard	1
1.2. Lexical Elements	2
1.2.1. Character Set	2
1.2.2. Special Symbols	3
1.2.3. String Delimiters	3
1.2.4. Embedded String Constants	3
1.2.5. Reserved Words	4
1.2.6. Identifiers	5
1.3. Comments	7
1.4. Page Breaks and Form Feeds in Programs	8
Chapter 2. Data Types and Values	9
2.1. Ordinal Types	9
2.1.1. Integer Types	9
2.1.1.1. INTEGER and INTEGER64 Types	10
2.1.1.2. UNSIGNED and UNSIGNED64 Types	10
2.1.1.3. Integer Literals	11
2.1.1.4. INTEGER_ADDRESS Type	13
2.1.2. CHAR Type	13
2.1.3. BOOLEAN Type	14
2.1.4. Enumerated Types	14
2.1.5. Subrange Types	15
2.2. Real Types	16
2.3. Pointer Types	19
2.3.1. POINTER Type	21
2.4. Structured Types	21
2.4.1. ARRAY Types	22
2.4.1.1. ARRAY Components	23
2.4.1.2. ARRAY Constructors	23
2.4.2. RECORD Types	24
2.4.2.1. Records with Variants	26
2.4.2.2. Record Constructors	28
2.4.3. SET Type	31
2.4.3.1. Set Constructors	32
2.4.4. FILE Type	32
2.4.5. TEXT Type	33
2.4.6. Nonstandard Constructors	34
2.4.6.1. Nonstandard Array Constructors	34
2.4.6.2. Nonstandard Record Constructors	35
2.5. Schema Types	36
2.6. String Types	39
2.6.1. PACKED ARRAY OF CHAR Types	41

2.6.2. VARYING OF CHAR Types	42
2.6.3. STRING Schema Type	43
2.7. Null-Terminated Strings	44
2.8. TIMESTAMP Type	45
2.9. Static and Nonstatic Types	45
2.10. Type Compatibility	46
2.10.1. Structural Compatibility	46
2.10.2. Assignment Compatibility	47
Chapter 3. Declaration Section	51
3.1. CONST Section	51
3.2. LABEL Section	52
3.3. TO BEGIN DO Section	53
3.4. TO END DO Section	54
3.5. TYPE Section	55
3.6. VALUE Section	57
3.7. VAR Section	58
Chapter 4. Expressions and Operators	61
4.1. Expressions	61
4.2. Operators	62
4.2.1. Arithmetic Operators	62
4.2.2. Relational Operators	64
4.2.3. Logical Operators	65
4.2.4. String Operators	66
4.2.5. Set Operators	67
4.2.6. Type Cast Operator	68
4.2.7. Precedence of Operators	69
4.3. Structured Function-Return Values	71
4.4. Type Conversions	71
Chapter 5. Statements	73
5.1. Assignment Statement	73
5.2. BREAK Statement	74
5.3. CASE Statement	74
5.4. Compound Statement	75
5.5. CONTINUE Statement	76
5.6. Empty Statement	76
5.7. FOR Statement	76
5.8. GOTO Statement	78
5.9. IF Statement	78
5.10. Procedure Call	79
5.11. REPEAT Statement	80
5.12. RETURN Statement	80
5.13. WHILE Statement	81
5.14. WITH Statement	82
Chapter 6. Procedures and Functions	85
6.1. Routine Declarations	85
6.2. Routine Calls	87
6.3. Parameters	89
6.3.1. Value Parameters	90
6.3.2. Variable Parameters	92
6.3.3. Routine Parameters	94

6.3.4. Passing Predeclared Functions to Formal Function Parameters	95
6.3.5. Foreign Parameters	96
6.3.6. Schema Parameters	98
6.3.7. Conformant Parameters	100
6.3.7.1. Conformant Array Parameters	100
6.3.7.2. Conformant VARYING Parameter	101
6.3.7.3. Conformant Parameter Sections	102
6.3.8. Parameter Association	103
6.3.9. Default Formal Parameters	104
Chapter 7. Program Structure and Scope	107
7.1. Blocks	107
7.2. Scope of Identifiers	107
7.3. Redeclaring Routine Names	108
7.4. Modules and Programs	110
7.5. Compilation Units and Data Sharing	111
7.5.1. Environment Files	111
7.5.2. Global and External Identifiers	113
Chapter 8. Predeclared Functions and Procedures	115
8.1. ABS Function	116
8.2. ADD_ATOMIC Function (OpenVMS I64 and OpenVMS Alpha systems only)	116
8.3. ADD_INTERLOCKED Function	117
8.4. ADDRESS Function	117
8.5. AND_ATOMIC Function (OpenVMS I64 and OpenVMS Alpha systems only)	118
8.6. ARCTAN Function	118
8.7. ARGUMENT Function	118
8.8. ARGUMENT_LIST_LENGTH Function	119
8.9. ASSERT Procedure	119
8.10. BARRIER Function (OpenVMS I64 and OpenVMS Alpha systems only)	120
8.11. BIN Function	120
8.12. BIT_OFFSET Function	121
8.13. BITNEXT Function	121
8.14. BITSIZE Function	121
8.15. BYTE_OFFSET Function	122
8.16. C_STR Function	122
8.17. CARD Function	122
8.18. CHR Function	123
8.19. CLEAR_INTERLOCKED Function	123
8.20. CLOCK Function	123
8.21. COS Function	123
8.22. CREATE_DIRECTORY Procedure	123
8.23. DATE and TIME Functions	124
8.24. DATE and TIME Procedures	124
8.25. DBLE Function	125
8.26. DEC Function	125
8.27. DELETE_FILE Procedure	125
8.28. DISPOSE Procedure	126
8.29. EQ Function	126
8.30. ESTABLISH Procedure	127
8.31. EXP Function	127
8.32. EXPO Function	127
8.33. FIND_FIRST_BIT_CLEAR Function	127

8.34. FIND_FIRST_BIT_SET Function	128
8.35. FIND_MEMBER Function	128
8.36. FIND_NONMEMBER Function	128
8.37. GE Function	129
8.38. GETTIMESTAMP Procedure	129
8.39. GT Function	130
8.40. HALT Procedure	130
8.41. HEX Function	130
8.42. IADDRESS Function	131
8.43. IADDRESS64 Function	132
8.44. IN_RANGE Function	132
8.45. INDEX Function	132
8.46. INT Function	133
8.47. INT64 Function	133
8.48. LE Function	133
8.49. LENGTH Function	134
8.50. LN Function	134
8.51. LOWER Function	134
8.52. LSHIFT Function	134
8.53. LT Function	135
8.54. MALLOC_C_STR Function	135
8.55. MAX Function	136
8.56. MIN Function	136
8.57. NE Function	136
8.58. NEW Procedure	136
8.59. NEXT Function	138
8.60. OCT Function	138
8.61. ODD Function	139
8.62. OR_ATOMIC Function (OpenVMS I64 and OpenVMS Alpha systems only)	139
8.63. ORD Function	139
8.64. PACK Procedure	139
8.65. PAD Function	140
8.66. PAS_STR Function	140
8.67. PAS_STRCPY Function	141
8.68. PRED Function	141
8.69. PRESENT Function	141
8.70. QUAD Function	141
8.71. RANDOM Function	142
8.72. READV Procedure	142
8.73. RENAME_FILE Procedure	143
8.74. REVERT Procedure	143
8.75. ROUND Function	143
8.76. ROUND64 Function	144
8.77. RSHIFT Function	144
8.78. SEED Function	144
8.79. SET_INTERLOCKED Function	144
8.80. SIN Function	145
8.81. SIZE Function	145
8.82. SNGL Function	146
8.83. SQR Function	146
8.84. SQRT Function	146
8.85. STATUSV Function	146

8.86. SUBSTR Function	147
8.87. SUCC Function	148
8.88. SYSCLOCK Function	148
8.89. TIME Procedure	148
8.90. TRUNC Function	148
8.91. TRUNC64 Function	148
8.92. UAND Function	148
8.93. UDEC Function	149
8.94. UINT Function	149
8.95. UINT64 Function	150
8.96. UNDEFINED Function	150
8.97. UNOT Function	150
8.98. UNPACK Procedure	151
8.99. UOR Function	151
8.100. UPPER Function	152
8.101. UROUND Function	152
8.102. UROUND64 Function	152
8.103. UTRUNC Function	153
8.104. UTRUNC64 Function	153
8.105. UXOR Function	153
8.106. WALLCLOCK Function	153
8.107. WRITEV Procedure	154
8.108. XOR Function	155
8.109. ZERO Function	155
Chapter 9. Input and Output Processing	157
9.1. Files and File Organizations	157
9.1.1. Sequential File Organization	158
9.1.2. Relative File Organization	158
9.1.3. Indexed File Organization	159
9.2. Component Formats	161
9.2.1. Fixed-Length Component Format	163
9.2.2. Variable-Length Component Format	164
9.2.3. Stream Component Format	164
9.3. Component Access Modes	164
9.3.1. Sequential Access	165
9.3.1.1. Sequential Access to Sequential Files	165
9.3.1.2. Sequential Access to Relative Files	166
9.3.1.3. Sequential Access to Indexed Files	167
9.3.2. Random Access	167
9.3.2.1. Random Access by Relative Component Numbers (Direct Access)	168
9.3.2.2. Random Access to Indexed Files (Keyed Access)	168
9.4. File Locking	169
9.5. TEXT Files	169
9.5.1. Carriage Control	170
9.5.2. Prompting on a Terminal	170
9.5.3. Delayed Device Access to Text Files	171
9.5.4. Writing Partial Lines to Terminals	173
9.6. Formatting Output	173
9.6.1. Specifying the Field Width	173
9.6.2. Writing Real Numbers	174
9.6.3. Explicitly Specifying the Base	175
9.6.4. Specifying the Base with Predeclared Conversion Functions	175

9.6.5. Writing Nonnumeric Types	176
9.7. Error-Processing Parameter	177
9.8. I/O Routines	177
9.8.1. CLOSE Procedure	178
9.8.2. DELETE Procedure	179
9.8.3. EOF Function	180
9.8.4. EOLN Function	181
9.8.5. EXTEND Procedure	182
9.8.6. FIND Procedure	183
9.8.7. FINDK Procedure	184
9.8.8. GET Procedure	185
9.8.9. LINELIMIT Procedure	187
9.8.10. LOCATE Procedure	187
9.8.11. OPEN Procedure	188
9.8.12. PAGE Procedure	192
9.8.13. PUT Procedure	193
9.8.14. READ Procedure	194
9.8.15. READLN Procedure	197
9.8.16. RESET Procedure	198
9.8.17. RESETK Procedure	200
9.8.18. REWRITE Procedure	201
9.8.19. STATUS Function	202
9.8.20. TRUNCATE Procedure	203
9.8.21. UFB Function	203
9.8.22. UNLOCK Procedure	204
9.8.23. UPDATE Procedure	204
9.8.24. WRITE Procedure	205
9.8.25. WRITELN Procedure	206
Chapter 10. Attributes	209
10.1. Attribute Syntax	209
10.2. Attributes	211
10.2.1. ALIGN	211
10.2.2. ALIGNED	212
10.2.3. ASYNCHRONOUS	213
10.2.4. AT	214
10.2.5. AUTOMATIC	215
10.2.6. BIT	215
10.2.7. BYTE	216
10.2.8. CHECK	216
10.2.9. CLASS_A	218
10.2.10. CLASS_NCA	218
10.2.11. CLASS_S	218
10.2.12. COMMON	219
10.2.13. ENUMERATION_SIZE	220
10.2.14. ENVIRONMENT	220
10.2.15. EXTERNAL	221
10.2.16. FLOAT	222
10.2.17. GLOBAL	223
10.2.18. HIDDEN	223
10.2.19. IDENT	224
10.2.20. IMMEDIATE	224
10.2.21. INHERIT	224

10.2.22. INITIALIZE	225
10.2.23. KEY	226
10.2.24. LIST	227
10.2.25. LOCAL	229
10.2.26. LONG	229
10.2.27. NOOPTIMIZE	230
10.2.28. OCTA	230
10.2.29. OPTIMIZE	231
10.2.30. PEN_CHECKING_STYLE	232
10.2.31. POS	233
10.2.32. PSECT	234
10.2.33. QUAD	234
10.2.34. READONLY	234
10.2.35. REFERENCE	236
10.2.36. STATIC	236
10.2.37. TRUNCATE	237
10.2.38. UNALIGNED	239
10.2.39. UNBOUND	239
10.2.40. UNSAFE	240
10.2.41. VALUE	242
10.2.42. VOLATILE	243
10.2.43. WEAK_EXTERNAL	246
10.2.44. WEAK_GLOBAL	246
10.2.45. WORD	247
10.2.46. WRITEONLY	247
10.3. Attribute Classes	248
Chapter 11. Directives	253
11.1. %INCLUDE	253
11.2. %DICTIONARY	255
11.3. %TITLE and %SUBTITLE	256
11.4. %IF, %ELSE, %ELIF, and %ENDIF	257
11.5. %DEFINED	258
11.6. %ERROR, %WARN, %INFO, and %MESSAGE	258
11.7. %ARCH_NAME, %SYSTEM_NAME, and %SYSTEM_VERSION	259
11.8. %DATE, %TIME, and %COMPILER_VERSION	260
11.9. %LINE, %FILE, %ROUTINE, %MODULE, and %IDENT	260
Appendix A. Data Storage and Representation	261
A.1. Program Sections	261
A.1.1. Establishing Program Sections	261
A.1.2. Establishing Program Section Properties	264
A.2. Storage Allocation	265
A.2.1. Allocation of Variables	265
A.2.2. Allocation of Symbolic Constants and Executable Blocks	266
A.2.3. Allocation Example	266
A.2.4. Allocation Sizes of Variables	267
A.2.5. Storage Allocation of Types	268
A.2.6. Allocation Size Examples	270
A.2.7. Alignment Boundaries	271
A.3. Internal Representation of Data Types	274
A.3.1. Representation of Varying Data	274
A.3.2. Representation of Floating-Point Data	274

A.3.2.1. F_floating-Point Numbers	275
A.3.2.2. S_floating-Point Numbers	275
A.3.2.3. D_floating-Point Numbers	276
A.3.2.4. G_floating-Point Numbers	276
A.3.2.5. T_floating-Point Numbers	277
A.3.2.6. H_floating-Point Numbers	277
A.3.2.7. X_floating-Point Numbers	278
A.3.3. Representation of Nonstatic Types and Variables	279
A.3.3.1. Representation of Nonstatic Types	279
A.3.3.2. Representation of Variables of Nonstatic Types	281
A.3.3.3. Representation of Nonstatic Record Fields	282
Appendix B. Summary of VSI Pascal for OpenVMS Extensions	283
B.1. VSI Pascal for OpenVMS Extensions to Unextended Pascal	283
B.2. VSI Pascal for OpenVMS Extensions to Extended Pascal	286
Appendix C. Description of Implementation Features	289
C.1. Implementation-Defined Features	289
C.2. Implementation-Dependent Features	290
Appendix D. Compiler and Run-Time System Error Detection	293
D.1. Error Message Information	293

Preface

This manual describes the VSI Pascal programming language. It contains information on:

- VSI Pascal language syntax and semantics
- VSI Pascal adherence to Pascal standards
- VSI Pascal extensions to standards

All references to OpenVMS systems refer to the OpenVMS I64, OpenVMS Alpha, and OpenVMS VAX operating systems unless otherwise specified.

1. Intended Audience

This manual is for experienced applications programmers with a basic understanding of the Pascal language. Some familiarity with your operating system is helpful. This is not a tutorial manual.

2. Document Structure

This manual consists of the following chapters and appendixes:

- Chapter 1 describes Pascal language standards and lexical elements.
- Chapter 2 describes data types and values.
- Chapter 3 describes declaration sections.
- Chapter 4 describes expressions and operators.
- Chapter 5 describes statements.
- Chapter 6 describes user-written procedures and functions.
- Chapter 7 describes program structure and scope.
- Chapter 8 describes predeclared procedures and functions, except those that perform input and output.
- Chapter 9 describes the predeclared procedures and functions that perform input and output.
- Chapter 10 describes attributes.
- Chapter 11 describes directives.
- Appendix A describes the storage allocation and alignment for data types and the internal representation of each data type.
- Appendix B describes the VSI Pascal extensions to the Pascal standards.
- Appendix C describes the VSI Pascal implementation features that the Pascal standards allow each implementation to define.
- Appendix D describes how the VSI Pascal compiler detects errors defined by the Pascal standard.

3. Related Documents

The following documents might also be useful when programming in VSI Pascal:

- *VSI Pascal for OpenVMS User Manual*—Provides information about programming tasks, about using features in conjunction with one another, and about increasing the efficiency of program execution.
- *VSI Pascal for OpenVMS Installation Guide*—Provides information on how to install VSI Pascal on your operating system.

4. VSI Encourages Your Comments

You may send comments or suggestions regarding this manual or any VSI document by sending electronic mail to the following Internet address: <docinfo@vmssoftware.com>. Users who have OpenVMS support contracts through VSI can contact <support@vmssoftware.com> for help with this product.

5. OpenVMS Documentation

The full VSI OpenVMS documentation set can be found on the VMS Software Documentation webpage at <https://docs.vmssoftware.com>

6. Conventions

The following conventions are used in this manual:

Convention	Meaning
Ctrl/ <i>x</i>	A sequence such as Ctrl/ <i>x</i> indicates that you must hold down the key labeled Ctrl while you press another key or a pointing device button.
PF1 <i>x</i>	A sequence such as PF1 <i>x</i> indicates that you must first press and release the key labeled PF1 and then press and release another key or a pointing device button.
. . .	A horizontal ellipsis in examples indicates one of the following possibilities: <ul style="list-style-type: none"> • Additional optional arguments in a statement have been omitted. • The preceding item or items can be repeated one or more times. <p>Additional parameters, values, or other information can be entered.</p>
. . . .	A vertical ellipsis indicates the omission of items from a code example or command format; the items are omitted because they are not important to the topic being discussed.
()	In command format descriptions, parentheses indicate that you must enclose choices in parentheses if you specify more than one.
[]	In command format descriptions, brackets indicate optional choices. You can choose one or more items or no items. Do not type the brackets on the command line. However, you must include the brackets in the syntax for OpenVMS directory specifications and for a substring specification in an assignment statement.

Convention	Meaning
	In command format descriptions, vertical bars separate choices within brackets or braces. Within brackets, the choices are optional; within braces, at least one choice is required. Do not type the vertical bars on the command line.
{ }	In command format descriptions, braces indicate required choices; you must choose at least one of the items listed. Do not type the braces on the command line.
bold type	Bold type represents the name of an argument, an attribute, or a reason.
<i>italic type</i>	Italic type indicates important information, complete titles of manuals, or variables. Variables include information that varies in system output (Internal error <i>number</i>), in command lines (<i>/PRODUCER=name</i>), and in command parameters in text (where <i>dd</i> represents the predefined code for the device type).
UPPERCASE TYPE	Uppercase type indicates a command, the name of a routine, the name of a file, or the abbreviation for a system privilege.
–	A hyphen at the end of a command format description, command line, or code line indicates that the command or statement continues on the following line.
numbers	All numbers in text are assumed to be decimal unless otherwise noted. Nondecimal radixes – binary, octal, or hexadecimal – are explicitly indicated.

Chapter 1. Language Elements

VSI Pascal is a general-purpose programming language. This chapter describes the following information and components of the VSI Pascal language:

- Section 1.1: Pascal Language Standards
- Section 1.2: Lexical Elements
- Section 1.3: Comments
- Section 1.4: Page Breaks and Form Feeds in Programs

1.1. Pascal Language Standards

The VSI Pascal compiler accepts programs that comply with two standards and a subset of programs that comply with a third. VSI Pascal also provides features (called **extensions**) that are not part of any standard. For portable code, limit your use of these extensions or isolate the extensions in separate modules.

1.1.1. Unextended Pascal Standards

The **unextended Pascal** standards are as follows:

- American National Standard ANSI/IEEE770X3.97-1989 (ANSI)
- International Standard ISO 7185-1989 (ISO)

VSI Pascal accepts programs that comply to either standard. In the VSI Pascal documentation set, the term “unextended Pascal” applies to both the ANSI and ISO standards.

VSI Pascal contains FIPS-109 (Federal Information Processing Standard) validation support.

The standards are divided into two levels of standardization: Level 0 and Level 1. An example of a technical difference between the Level 0 standard and the Level 1 standard is that Level 0 does not include conformant arrays, while Level 1 does.

VSI Pascal has passed the validation suite for Pascal compilers. It received a CLASS A certificate for both levels of the ISO standard as well as the ANSI standard. CLASS A certificates are given to compilers with a fully conforming implementation.

For More Information:

- On VSI Pascal extensions to unextended Pascal (Appendix B)
- On VSI Pascal implementation-dependent features (Appendix C)
- On VSI Pascal error processing as defined by the standards (Appendix D)
- On flagging nonstandard constructs during compilation (*VSI Pascal for OpenVMS User Manual*)

1.1.2. Extended Pascal Standard

The **Extended Pascal** standard is a superset of the unextended Pascal standards. The Extended Pascal standards are as follows:

- American National Standard ANSI/IEEE770X3.160-1989
- International Standard ISO 10206-1989

In the VSI Pascal documentation set, the term Pascal standard refers to these standards. Because VSI Pascal supports most Extended Pascal standard features, it cannot compile all programs that comply with Extended Pascal.

For More Information:

- On VSI Pascal support for Extended Pascal features (Appendix B)
- On flagging nonstandard constructs during compilation (*VSI Pascal for OpenVMS User Manual*)

1.2. Lexical Elements

This section discusses **lexical elements** of the VSI Pascal language.

1.2.1. Character Set

VSI Pascal uses the extended American Standard Code for Information Interchange (ASCII) character set. This extended ASCII character set contains 256 characters, which include the following:

- Uppercase letters A through Z and lowercase letters a through z
- Integers 0 through 9
- Special characters, such as the ampersand (&), question mark (?), and equal sign (=)
- Nonprinting characters, such as the space, tab, line feed, carriage return, and form feed (use of these characters can improve the legibility of your programs)
- Extended, unspecified characters with numeric codes from 128 to 255

Each ASCII character corresponds to a numeric value.

Each element of the character set is a constant of the predefined VSI Pascal type CHAR. An ASCII decimal number is the same as the ordinal value (as returned by the Pascal ORD function) of the associated character in the type CHAR.

VSI Pascal allows full use of eight-bit characters.

The VSI Pascal compiler does not distinguish between uppercase and lowercase characters except when they appear inside single or double quotation marks. For example, the word PROGRAM has the same meaning when written as any of the following:

```
PROGRAM  
PRoGrAm  
program
```

The characters in each pair of characters, however, represent different values:

```
'b'  'B'
```

"c" "C"

1.2.2. Special Symbols

Special symbols represent operators, delimiters, and other syntactic elements. Some symbols are composed of more than one character; you cannot place a space between the characters of these special symbols. Table 1.1 lists the VSI Pascal special symbols.

Table 1.1. Special Symbols

Symbol	Name	Symbol	Name
'	Apostrophe	<=	Less than or equal to
:=	Assignment operator	-	Minus sign
[] or (.)	Brackets	*	Multiplication
:	Colon	<>	Not equal
,	Comma	()	Parentheses
(* *) or { }	Comments	%	Percent
/	Division	.	Period
"	Double quote	+	Plus sign
=	Equal sign	^ or @	Pointer
**	Exponentiation	;	Semicolon
>	Greater than	..	Subrange operator
>=	Greater than or equal to	::	Type cast operator
<	Less than		

1.2.3. String Delimiters

VSI Pascal accepts single-quote and double-quote characters as string and character delimiters.

1.2.4. Embedded String Constants

Within double quotation marks, VSI Pascal supports constant characters specified with a backslash, in a syntax similar to that of the C programming language. Table 1.2 lists the constants supported by VSI Pascal.

Table 1.2. Embedded String Constants

Constant	Definition	ASCII Value
\a	Bell character	16#7
\b	Backspace character	16#8
\f	Form-feed character	16#C
\n	Line-feed character	16#A
\r	Carriage-return character	16#D
\t	Horizontal tab character	16#9
\v	Vertical character	16#B

Constant	Definition	ASCII Value
\\	Backslash character	16#5C
\"	Double-quotation character	16#22
\'	Single-quotation character	16#27
\nnn	Character whose value is nnn	nnn is an octal number from 000 to 377. Leading zeros can be omitted.
\xnn	Character whose value is nn	nn is a hexadecimal number from 00 to FF. Leading zeros can be omitted.

1.2.5. Reserved Words

Reserved words are used to designate data types, directives, identifiers, specifiers, statements, and operators. You cannot redefine these identifiers. Table 1.3 presents the VSI Pascal reserved words.

Table 1.3. Reserved Words

%DESCR	%DICTIONARY	%IMMED	%INCLUDE
%REF	%STDESCR	%SUBTITLE	%TITLE
AND	ARRAY	BEGIN	CASE
CONST	DIV	DO	DOWNTO
ELSE	END	FILE	FOR
FUNCTION	GOTO	IF	IN
LABEL	MOD	NIL	NOT
OF	OR	PACKED	PROCEDURE
PROGRAM	RECORD	REPEAT	SET
THEN	TO	TYPE	UNTIL
VAR	WHILE	WITH	

The manuals in the VSI Pascal documentation set show these reserved words in uppercase letters. If you choose, you can express them in mixed case or lowercase in your programs.

Table 1.4 presents the **redefinable reserved words** that are used to name operators and identifiers. You can redeclare these words, but, if you do, the language feature becomes unavailable within the block in which you redeclare the word.

Table 1.4. Redefinable Reserved Words

AND_THEN	BREAK	CONTINUE	MODULE
OR_ELSE	OTHERWISE	REM	RETURN
VALUE	VARYING		

Note

This table does not include statements that are only provided by VSI Pascal for compatibility with other Pascal compilers.

This manual shows redefinable reserved words in uppercase letters. If you choose, you can express them in mixed case or lowercase in your programs.

1.2.6. Identifiers

An **identifier** is a combination of letters, digits, [dollar signs \(\\$\)](#), and [underscores \(_\)](#) that conforms to the following restrictions:

- An identifier cannot start with a digit.
- An identifier cannot contain spaces or special symbols.
- The first 31 characters of an identifier must denote a unique name within the block in which the identifier is declared. An identifier longer than 31 characters generates a warning message. The compiler ignores characters beyond the thirty-first character
- The Pascal standard dictates that an identifier cannot start or end with an underscore, nor can two adjacent underscores be used within an identifier. [However, VSI Pascal allows both cases of underscore use and generates an informational message if you compile with the standard switch.](#)

On VSI OpenVMS systems, VSI Pascal uses uppercase characters for all external user symbols.

You can provide a string argument to the GLOBAL, WEAK_GLOBAL, EXTERNAL, and WEAK_EXTERNAL attributes to override this case usage. VSI Pascal passes the string unmodified to the linker.

This manual shows predeclared identifiers in uppercase letters. If you choose, you can express them in mixed case or lowercase in your programs. The following examples show valid and invalid identifiers:

Valid:

```
For2n8
MAX_WORDS
upto
LOGICAL_NAME_TABLE      {Unique in first}
Logical_Name_Scanner    { 31 characters}
```

[SYS\\$CREMBX](#)

Invalid:

4Awhile	{Starts with a digit}
up&to	{Contains an ampersand}
YEAR_END_87_MASTER_FILE_TOTAL_DISCOUNT	{Not unique in first}
Year_End_87_Master_File_Total_Dollars	{ 31 characters}

Table 1.5 presents the VSI Pascal **predeclared identifiers** that name data types, symbolic constants, file variables, procedures, and functions. You can redefine a predeclared identifier, but if you do, the original declaration becomes unavailable within the block in which you redeclared the word.

Table 1.5. Predeclared Identifiers

ABS	ADD_ATOMIC	ADD_INTERLOCKED	ADDRESS
AND_ATOMIC	ARCTAN	ARGC	ARGUMENT
ARGUMENT_LIST_LENGTH	ARGV	ASSERT	
BARRIER	BIN	BIT_OFFSET	BITNEXT
BITSIZE	BOOLEAN	BYTE_OFFSET	
CARD	CARDINAL	CARDINAL16	CARDINAL32
CHAR	CHR	CLEAR_INTERLOCKED	CLOCK
C_STR	C_STR_T	CLOSE	COS
CREATE_DIRECTORY			
D_FLOAT	DATE	DBLE	DEC
DELETE	DELETE_FILE	DISPOSE	DOUBLE
EOF	EOLN	EPSDOUBLE	EPSQUADRUPLE
EPSREAL	EQ	ESTABLISH	EXP
EXPO	EXTEND		
F_FLOAT	FALSE	FIND	FIND_FIRST_BIT_CLEAR
FIND_FIRST_BIT_SET	FIND_MEMBER	FIND_NONMEMBER	FINDK
G_FLOAT	GE	GET	GETTIMESTAMP
GT			
H_FLOAT	HALT	HEX	
IADDRESS	IADDRESS64	INDEX	INPUT
INT	INTEGER	INTEGER8	INTEGER16
INTEGER32	INTEGER64	INTEGER_ADDRESS	
LE	LENGTH	LINELIMIT	LN
LOCATE	LOWER	LSHIFT	LT
MALLOC_C_STR	MAX	MAXCHAR	MAXDOUBLE
MAXINT	MAXQUADRUPLE	MAXREAL	MAXUNSIGNED
MIN	MINDOUBLE	MINQUADRUPLE	MINREAL
NE	NEW	NEXT	NIL

OCT	ODD	OPEN	OR_ATOMIC
ORD	OUTPUT		
PACK	PAD	PAGE	PAS_STR
PAS_STRCPY	POINTER	PRED	PRESENT
PUT			
QUAD	QUADRUPLE		
RANDOM	READ	READLN	READV
REAL	RENAME_FILE	RESET	RESETK
REVERT	REWRITE	ROUND	ROUND64
RSHIFT			
S_FLOAT	SEED	SET_INTERLOCKED	SIN
SINGLE	SIZE	SNGL	SQR
SQRT	STATUS	STATUSV	STRING
SUBSTR	SUCC	SYSCLOCK	
T_FLOAT	TEXT	TIME	TIMESTAMP
TRUE	TRUNC	TRUNC64	TRUNCATE
UAND	UDEC	UFB	UINT
UNDEFINED	UNLOCK	UNOT	UNPACK
UNSIGNED	UNSIGNED8	UNSIGNED16	UNSIGNED32
UNSIGNED64	UOR	UPDATE	UPPER
UROUND	UROUND64	UTRUNC	UTRUNC64
UXOR			
WALLCLOCK	WRITE	WRITELN	WRITEV
X_FLOAT	XOR		
ZERO			

Note

This table does not include predefined identifiers that are only provided by VSI Pascal for compatibility with other Pascal compilers.

For More Information:

- On attributes (Chapter 10)

1.3. Comments

Comments document the actions or elements of a program. The text of a comment can contain any ASCII character except a nonprinting control character, such as an ESCAPE character. You can place comments anywhere in a program that white space can appear.

You signify a comment with braces or with a parenthesis and asterisk pair, as follows:

```
{ This is a comment. }
```

```
(* This is a comment, too. *)
```

VSI Pascal allows you to mix the two symbol pairs in one comment, as follows:

```
{ The delimiters of this comment do not match. *}  
(* VSI Pascal allows you to mix delimiters in this way. }
```

VSI Pascal does not allow you to nest comments. The following example causes a compile-time error because the comment ends at the first closing delimiter (}).

```
(* Cannot { nest comments inside } of comments like this *)
```

The `%IF` directive can be used to essentially comment out large sections of code as follows:

```
%IF FALSE  
%THEN  
...code to disable...  
%ENDIF
```

For more information on `%IF`, see Section 11.4.

VSI Pascal allows for an end-of-line comment using an exclamation point (!). If an exclamation point is encountered on a line in the source program, the remainder of that line will be treated as a comment.

This comment syntax is not recognized by SCA for report generation.

1.4. Page Breaks and Form Feeds in Programs

A page break or form-feed character can appear anywhere in your program except on a line with text surrounding the form feed. For example, the following lines are legal:

```
FF  
%TITLE 'Variable Declarations'  
end; FF  
FF  
FF VAR FF
```

However, the following line generates an error:

```
BEGIN FF END
```

The page break does not affect the meaning of the program, but causes a page to eject at the corresponding line in a listing file.

Chapter 2. Data Types and Values

Every piece of data that is created or manipulated by an VSI Pascal program has a **data type**. The data type determines the range of values, set of valid operations, and maximum storage allocation for each piece of data.

This chapter describes the following topics:

- Ordinal types (Section 2.1)
- Real types (Section 2.2)
- Pointer types (Section 2.3)
- Structured types (Section 2.4)
- Schema types (Section 2.5)
- String schemas and types (Section 2.6)
- Predefined `TIMESTAMP` type (Section 2.8)
- Static and nonstatic types (Section 2.9)
- Rules of type compatibility (Section 2.10)

For More Information:

- On user-defined types and the `TYPE` section (Section 3.5)
- On variable declarations and the `VAR` section (Section 3.7)
- On automatic type conversions (Section 4.4)
- On type conversion functions (Chapter 8)
- Internal representation of data types (Section A.3)

2.1. Ordinal Types

This section describes the ordinal types that are predefined by VSI Pascal and user-defined ordinal types (types that require you to provide identifiers or boundary values to completely define the data type).

The ranges of values for these types are ordinal in nature; the values are ordered so that each has a unique ordinal value indicating its position in a list of all the values of that type. There is a one-to-one correspondence between the values in an ordinal type and the set of positive integers.

2.1.1. Integer Types

VSI Pascal makes available the `INTEGER`, `INTEGER64`, `UNSIGNED`, `UNSIGNED64`, and `INTEGER_ADDRESS` predeclared types. These data types are described in Section 2.1.1.1, Section 2.1.1.2, and Section 2.1.1.4, respectively.

2.1.1.1. INTEGER and INTEGER64 Types

VSI Pascal provides the `INTEGER` and `INTEGER64` (not available on all systems) integer types. Also provided are the `INTEGER8`, `INTEGER16`, and `INTEGER32` types, which are used as synonyms for subranges of the `INTEGER` type.

The range of the integer values consists of positive and negative integer values, and of the value 0. The range boundaries depend on the architecture of the machine you are using.

Table 2.1 lists the storage sizes and ranges of values for these signed ordinal types.

Table 2.1. Range of Values of Integer Ordinal Types

Data Type	Size	Range
<code>INTEGER8</code>	8 bits	-128..127 16#80..16#7F
<code>INTEGER16</code>	16 bits	-32768..32767 16#8000..16#7FFF
<code>INTEGER32</code>	32 bits	-2147483648..2147483647 16#80000000..16#7FFFFFFF
<code>INTEGER64</code>	64 bits	-9223372036854775808..9223372036854775807 16#8000000000000000..16#7FFFFFFFFFFFFFFF

The largest possible value of the `INTEGER64` type is represented by the predefined constant `MAXINT64`. The smallest possible value of the `INTEGER64` type is represented by the value of the expression `-MAXINT64`. While the value of `-MAXINT64-1` can also be represented, correct results may not be produced in certain expressions.

The largest possible value of the `INTEGER` type is represented by the predefined constant `MAXINT`. The smallest possible value of the `INTEGER` type is represented by the value of the expression `-MAXINT`. While the value `-MAXINT-1` can also be represented, it may not produce correct results in certain expressions.

Table 2.2 lists the sizes and the corresponding values of `MAXINT` and `MAXINT64`.

Table 2.2. Values of MAXINT and MAXINT64 Predeclared Constants

Constant	Size	Value
<code>MAXINT</code>	32 bits	$(2^{31})-1$ 16#7FFFFFFF
<code>MAXINT64</code>	64 bits	$(2^{63})-1$ 16#7FFFFFFFFFFFFFFF

2.1.1.2. UNSIGNED and UNSIGNED64 Types

VSI Pascal provides the `UNSIGNED` and `UNSIGNED64` types (not available on all systems). Also provided are the `UNSIGNED32`, `CARDINAL`, `CARDINAL16`, and `CARDINAL32` types, which are used as synonyms for subranges of the `UNSIGNED` type. `UNSIGNED8` and `UNSIGNED16` are provided as synonyms for subranges of `INTEGER` with positive values that correspond to an `UNSIGNED` subrange of the same size. The range of unsigned values consists of nonnegative integer values.

The unsigned data types are VSI Pascal extensions that are provided to facilitate systems programming using certain operating systems. Given that these data types are not standard, you should not use them for every application involving nonnegative integers.

Table 2.3 lists the range of values for unsigned numbers.

Table 2.3. Range of Values of Unsigned Ordinal Types

Data Type	Size	Range
UNSIGNED8	8 bits	0..255 0..16#FF
UNSIGNED16, CARDINAL16	16 bits	0..65535 ($2^{16}-1$) 0..16#FFFF
UNSIGNED32, CARDINAL32	32 bits	0..4294967295 ($2^{32}-1$) 0..16#FFFFFFFF
UNSIGNED64	64 bits	0..18446744073709551615 ($2^{64}-1$) 0..16#FFFFFFFFFFFFFFFF

The largest possible value of the UNSIGNED type is represented by the predefined constant MAXUNSIGNED. The smallest possible value of the UNSIGNED type is 0.

The largest possible value of the UNSIGNED64 type is represented by the predefined constant MAXUNSIGNED64. The smallest possible value of the UNSIGNED64 type is 0.

Table 2.4 lists the sizes and the corresponding values of MAXUNSIGNED and MAXUNSIGNED64.

Table 2.4. Values of MAXUNSIGNED and MAXUNSIGNED64

Constant	Size	Value	
MAXUNSIGNED	32 bits	$(2^{32})-1$	16#FFFFFFFF
MAXUNSIGNED64	64 bits	$(2^{64})-1$	16#FFFFFFFFFFFFFFFF

2.1.1.3. Integer Literals

Literal values of the INTEGER type have the following form:

```

{ decimal-number }
{ base-number#[[']]extended-digit[[']] }
{- } { }
[[ { } ]] { {b } }
{+ } { % {o } [[']]extended-digit[[']] }
{ { } }
{ {x } }
{ }

```

`decimal-number`

Specifies an integer in conventional Pascal integer notation. You cannot specify commas or decimal points. Examples of decimal notation are as follows:

```
17          0          89324
```

`base-number`

Specifies the base, or **radix**, of the number. VSI Pascal accepts numbers in bases 2 through 36.

`extended-digit`

Specifies the notation that is appropriate for the specified base.

b
o
x

Specifies an integer in either binary (base 2), octal (base 8), or hexadecimal (base 16) notation. In VSI Pascal you can use either uppercase or lowercase letters to specify the extended-digit notation.

You can use **extended-digit notation** in the same way you use the conventional integer notation. The one restriction is that you cannot use extended-digit values as labels.

VSI Pascal allows the use of spaces and tabs to make the extended-digit notation easier to read. To use spaces and tabs, enclose the extended digit in single quotation marks (' ').

The following are integer values in the extended-digit notation:

```
2#10000011
```

```
2#'1000 0011'
```

```
32#1J
```

```
-16#'7FFF FFFF'
```

VSI Pascal provides another extended-integer convention only for the sake of compatibility with previous versions of the language. The following are extended-integer values in the VSI Pascal specific notation:

```
%b'1000 0011'
```

```
%O'7712'
```

```
-%x'DEC'
```

When VSI Pascal processes an integer constant, its type is based on its apparent value. Table 2.5 and Table 2.5 describe the type that is chosen for the integer constant.

Table 2.5. Data Types for Integer Constants for OpenVMS I64 and OpenVMS Alpha Systems

Range of Integer Values	Data Type
- MAXINT64...(- MAXINT) -1	INTEGER64
- MAXINT...MAXINT	INTEGER
MAXINT+1...MAXINT64	INTEGER64
MAXINT64+1...MAXUNSIGNED64	UNSIGNED64

To force an INTEGER constant to become UNSIGNED, INTEGER64, or UNSIGNED64, you can use the UINT, INT64, or the UINT64 predeclared routines, respectively.

To force an UNSIGNED constant to become INTEGER64 or UNSIGNED64, you can use the INT64 or UINT64 predeclared routines, respectively.

To force an INTEGER64 constant to become UNSIGNED64, you can use the UINT64 predeclared routine.

For More Information:

- On unary operators (Section 4.2)

- On built-in routines (Chapter 8)

2.1.1.4. INTEGER_ADDRESS Type

The `INTEGER_ADDRESS` data type has the same underlying size as a pointer. `INTEGER_ADDRESS` is equivalent to the `INTEGER` data type.

For More Information:

- On `INTEGER` notations (Section 2.1.1.1)
- On the `IADDRESS` function (Chapter 8)

2.1.2. CHAR Type

The `CHAR` data type consists of single character values from the ASCII character set. The largest possible value of the `CHAR` type is the predefined constant `MAXCHAR`.

To specify a character constant, enclose a printable ASCII character in single quotation marks. To specify the single-quote character, enclose two single quotation marks in single quotation marks. Each of the following is a valid character constant.

```
'A'  
'z'  
'0' { This is the character 0, not the integer value 0 }  
''' { The apostrophe or single quotation mark }  
'?'
```

You can also specify a character constant by enclosing printable ASCII characters in double quotation marks. To specify the double-quote character when using double quotation marks as delimiters, use the `\` escape sequence. Each of the following is a valid character constant:

```
"A"  
"z"  
"\\"" { The double quotation mark }  
"?"
```

The `ORD` function accepts parameters of type `CHAR`. The function return value is the ordinal value of the character in the ASCII character set.

You can specify a nonprinting character, such as a control character, by writing an empty string followed immediately by the ordinal value of the character in the ASCII character set, or by using the `CHR` function followed by the ordinal value of the character in the ASCII character set. The following examples show the two ways to specify the bell control character:

```
' '(7)  
CHR( 7 )
```

You can also specify certain nonprinting characters with syntax like that of the C programming language. Enter the predefined constant for the character within double quotation marks. For example, to specify the line-feed character, enter:

```
"\n"
```

For More Information:

- On the `ORD` function (Section 8.63)

- On the CHR function (Section 8.18)
- On the ASCII character set (Section 1.2.1)
- On character strings (Section 2.6)
- On using escape sequences within double quotation marks for nonprinting characters (Section 1.2.4)

2.1.3. BOOLEAN Type

Boolean values are the result of testing relationships for truth or validity. The BOOLEAN data type consists of the two predeclared identifiers FALSE and TRUE. The expression ORD(FALSE) results in the value 0; ORD(TRUE) returns the integer 1.

The relational operators operate on the ordinal, real, string, or set expressions, and produce a Boolean result.

For More Information:

- On the ORD function (Section 8.63)
- On relational operators (Section 4.2.2)

2.1.4. Enumerated Types

An enumerated type is a user-defined ordered set of constant values specified by identifiers. It has the following form:

```
{enumerated-identifier}, ...  
  
enumerated-identifier
```

The identifier of the enumerated type being defined. VSI Pascal allows a maximum of 65,535 identifiers in an enumerated type.

The values of an enumerated type begin with the value 0 and follow a left-to-right order. Subsequent identifiers have a value one greater than the identifier preceding it. Consider the following:

```
TYPE  
  Seasons = ( Spring, Summer, Fall, Winter );  
VAR  
  Some_Seasons : Seasons VALUE Winter;  {Initialized}
```

In this enumerated type, Spring (value 0) and Summer (value 1) are less than Fall (value 2) because they precede Fall in the list of constant values. Winter (value 3) is greater than Fall because it follows Fall.

The ORD function accepts expressions of an enumerated type.

An identifier in an enumerated type cannot be defined for any other purpose in the same block. Consider the following:

```
TYPE  
  Seasons2 = ( Fall, Winter, Spring );
```

This enumerated type cannot be defined in the same block as the previous type, because the identifiers Spring, Fall, and Winter would not be unique.

For More Information:

On the ORD function (Section 8.63)

2.1.5. Subrange Types

A subrange type is user-defined and specifies a limited portion of another ordinal type (called the base type). It has the following form:

```
lower-bound..upper-bound
```

```
lower-bound
```

A constant expression or a formal discriminant identifier that establishes the lower limit of the subrange.

```
upper-bound
```

A constant expression or formal discriminant identifier that establishes the upper limit of the subrange. The value of the upper bound must be greater than or equal to the value of the lower bound.

The base type can be any enumerated or predefined ordinal type. The values in the subrange type appear in the same order as they are in the base type. For example, the result of the ORD function applied to a value of a subrange type is the ordinal value that is associated with the relative position of the value in the base type, not in the subrange type.

You can use a subrange type anywhere in a program that its base type is legal. A value of a subrange type is converted to a value of its base type before it is used in an operation. All rules that govern the operations performed on an ordinal type pertain to subranges of that type.

Consider the following:

```

TYPE
  Day = ( Mon, Tues, Wed, Thur, Fri, Sat, Sun );
  Weekday = Mon..Fri;           {subrange of base type Day}
  Weekend = Sat..Sun;          {subrange of base type Day}
  Digit   = '0'..'9';          {subrange of base type CHAR}
  Month   = 1..31;              {subrange of base type INTEGER}
  National Debt = 1..92233720368 {subrange of base type INTEGER64}
  5477580;

```

Using size attributes with subrange types might lead to confusion when combined with subrange checking. Consider the following:

```
type word = [word] 0..65535;
```

```

procedure take_a_word( p : word );
begin
  writeln(p);
end;

begin
  take_a_word(90000);
end.

```

When VSI Pascal passes value parameters of a subrange type, the actual parameter is evaluated as an expression of the base type (INTEGER in the above case). This allows the actual parameter to be larger than the size attribute in the subrange. This is done to allow the subrange check in the called routine to function properly. For value parameters, VSI Pascal allocates a local variable of the parameter's type and then assigns the parameter into the local variable. That local variable is then used throughout the body of the routine wherever the parameter is referenced. Subrange checking is performed when an expression of the base type is assigned into a subrange variable. Therefore the above routine is similar to the following:

```
procedure take_a_word( p_ : integer );
  var p : word; { Local copy }
  begin
    p := p_;      { Make local copy and do range check from longword
                  integer expression into word subrange on assignment }
    writeln(p);
  end;
```

This means that VSI Pascal will fetch an entire longword from P_ when making the local copy. If you call Pascal functions from non-Pascal routines with value parameters that are subranges, you must pass the address of a value with the size of the base type. If subrange checking is disabled, the compiler can assume that the actual parameter is in range and can only fetch a word since that is sufficient to represent all valid values.

If the parameter was a VAR parameter, then the compiler would indeed only fetch a word since the formal parameter is an alias for the actual parameter and you are not allowed to pass expressions to a VAR parameter. The compiler assumes that the VAR parameter contains a valid value of the subrange. In other words, subranges are checked at assignment time and are considered valid when fetched.

For More Information:

- On ordinal types (Section 2.1)
- On compile-time and run-time expressions (Section 4.1)
- On attributes (Chapter 10)
- On predeclared routines (Chapter 8)
- On using schema types (*VSI Pascal for OpenVMS User Manual*)
- On the ORD function (Section 8.63)
- On the TYPE section (Section 3.5)
- On discriminant identifiers in subranges (Section 2.5)
- On using the CHECK attribute for subrange checking (Section 10.2.8)

2.2. Real Types

VSI Pascal predefines the REAL, SINGLE, DOUBLE, and QUADRUPLE data types in the floating-point formats listed in Table 2.6.

In this manual, the term REAL type refers to both the REAL and SINGLE types.

Table 2.6. Supported Floating-Point Formats

Data Type	Format	Precision	Default on
Single-precision REAL types ¹	VAX F_floating-point format ³	1 part in $2^{23} = 7$ decimal digits	OpenVMS VAX, VSI OpenVMS Alpha
	IEEE S_floating-point format	1 part in $2^{23} = 7$ decimal digits	VSI OpenVMS I64
Double-precision DOUBLE types ²	VAX D_floating-point ^{2 3}	1 part $2^{55} = 16$ decimal digits	OpenVMS VAX
	VAX G_floating-point format ³	1 part in $2^{52} = 15$ decimal digits	VSI OpenVMS Alpha
	IEEE T_floating-point format	1 part in $2^{52} = 15$ decimal digits	VSI OpenVMS I64
QUADRUPLE	VAX H_floating-point format	1 part in $2^{112} = 33$ decimal digits	OpenVMS VAX
	IEEE X_floating-point format	1 part in $2^{112} = 33$ decimal digits	VSI OpenVMS I64, VSI OpenVMS Alpha

¹Use the /FLOAT qualifier to specify the default floating-point format. The IEEE data types are not supported on VAX systems.

³On VSI OpenVMS I64 systems, F_floating, D_floating, and G_floating formats are implemented by transparently converting them to an appropriate IEEE floating format before performing any necessary operation and then transparently converting them back. This conversion to/from IEEE format might result in slightly different answers and precision than on VSI OpenVMS Alpha and OpenVMS VAX systems.

²On VSI OpenVMS Alpha systems, D_floating is not a fully supported data type; no D_floating arithmetic operations are provided in the architecture. For backward compatibility, D_floating binary data can be processed but without the last three bits of precision by automatically converting to G_floating format, performing G_floating operations, and converting back to D_floating format.

VSI Pascal also provides data types to allow the selection of floating types independent of the setting of the FLOAT qualifier or attribute. Table 2.7 identifies the built-in types available by system.

Table 2.7. Floating Data Types

Data Type	System
F_FLOAT	VSI OpenVMS I64, VSI OpenVMS Alpha
D_FLOAT	VSI OpenVMS I64, VSI OpenVMS Alpha
G_FLOAT	VSI OpenVMS I64, VSI OpenVMS Alpha
S_FLOAT	VSI OpenVMS I64, VSI OpenVMS Alpha
T_FLOAT	VSI OpenVMS I64 and VSI OpenVMS Alpha
X_FLOAT	VSI OpenVMS I64 and VSI OpenVMS Alpha

To express REAL numbers, you can use either decimal or exponential notation. To express DOUBLE or QUADRUPLE numbers, you must use exponential notation.

To express REAL numbers in decimal notation, use the set of decimal digits and a decimal point. At least one digit must appear on either side of the decimal point. The following are valid real numbers in decimal notation:

```

2.4
893.2497
8.0
0.0

```

To express real numbers in exponential notation, you include a real number or an integer, an uppercase or lowercase letter indicating the type of precision, and an integer exponent with its minus sign or optional plus sign. For example:

```

2.3E2
10.0E-1
9.14159e0

```

Table 2.8 presents the letters that indicate precision in exponential notation.

Table 2.8. Precision in Exponential Notation

Letters	Meaning
E or e	Single-precision real number. The integer exponent following this letter specifies the power of 10.
D or d	Double-precision real number. All double-precision numbers in your program must appear in this exponential format; otherwise, the compiler reverts to single-precision representation.
Q or q	Quadruple-precision real number. All quadruple-precision numbers in your program must appear in this exponential format; otherwise, the compiler reverts to single-precision format. On systems that do not support the quadruple data type, the letters Q and q are treated as double-precision numbers (D).

To express negative real numbers in exponential notation, use the negation operator (-). Remember that a negative real number such as $-4.5E+3$ is not a constant, but is actually an expression consisting of the negation operator (-) and the real number $4.5E+3$. Use caution when expressing negative real numbers in complex expressions.

Table 2.9 presents the identifiers that are predefined by VSI Pascal for use with the real data types.

Table 2.9. Predefined Identifiers for Real Data Types

Identifier	Value
Single-Precision F_floating	
MINREAL	2.938736E-39
MAXREAL	1.701412E+38
EPSREAL ¹	1.192093E-07
IEEE Single-Precision S_floating	
MINREAL	1.175494E-38
MAXREAL	3.402823E+38
EPSREAL	1.192093E-07
Double-Precision D_floating	
MINDOUBLE	2.938735877055719E-39
MAXDOUBLE	1.701411834604692E+38

Identifier	Value
EPSDOUBLE	2.77557561562891E-17
	2.22044604925031E-16 (OpenVMS I64 and OpenVMS Alpha)
Double-Precision G_floating	
MINDOUBLE	5.56268464626800E-309
MAXDOUBLE	8.98846567431158E+307
EPSDOUBLE	2.22044604925031E-016
IEEE Double-Precision T_floating	
MINDOUBLE	2.2250738585072014E-308
MAXDOUBLE	1.7976931348623157E+308
EPSDOUBLE	2.2204460492503131E-016
Quadruple-Precision H_floating	
MINQUADRUPLE	8.40525785778023376565669454330438E-4933
MAXQUADRUPLE	5.94865747678615882542879663314004E+4931
EPSQUADRUPLE	1.92592994438723585305597794258493E-0034
IEEE Quadruple-Precision X_floating	
MINQUADRUPLE	3.36210314311209350626267781732175E-4932
MAXQUADRUPLE	1.18973149535723176508575932662801E+4932
EPSQUADRUPLE	9.62964972193617926527988971292464E-0035

¹Smallest value of the REAL, DOUBLE, and QUADRUPLE data types, such that $((1.0 + \text{EPSREAL}) > 1.0)$, $((1.0\text{D}0 + \text{EPSDOUBLE}) > 1.0\text{D})$, and $((1.0\text{Q}0 + \text{EPSQUADRUPLE}) > 1.0\text{Q}0)$.

For More Information:

- On operators (Section 4.2)
- On the internal representation of real numbers (Section A.3.2)
- On compilation switches (*VSI Pascal for OpenVMS User Manual*)

2.3. Pointer Types

A **pointer type** allows you to refer to a dynamic variable. Dynamic variables do not have lifetimes that are strictly related to the scope of a routine, module, or program; you can create and eliminate them at various times during program execution. Also, pointer types clearly define the type of an object, but you can create or eliminate objects during program execution.

The syntax of a pointer type is as follows:

```
[[attribute-list]] ^ [[attribute-list]] base-type-identifier
attribute-list
```

One or more identifiers that provide additional information about the base type.

```
base-type-identifier
```

The type identifier of the dynamic variable to which the pointer refers. The base type can be any type name or schema name. (If the base type is an undiscriminated schema type, you need to supply actual discriminants when you call the NEW function.)

Unlike other variables, dynamic variables do not have identifiers. You can access them indirectly with pointers.

When you use pointers, you call the procedure NEW to allocate storage for dynamic variables. You call the procedure DISPOSE to deallocate this storage.

A variable of a pointer type refers to a dynamic variable of the base type and is said to be associated with that type. In the following example, the variable Ptr is associated with a record of type My_Rec:

```
TYPE
  My_Rec = RECORD
    Name : STRING( 30 );
    Age  : INTEGER;
  END VALUE [Name: 'Chris Lee'; Age: 29]; {Initialized}
VAR
  Ptr : ^My_Rec;

{In executable section:}
NEW( Ptr );
```

To reference the dynamic variable to which a pointer refers, write the pointer variable name followed by a circumflex (^). The following example assigns values to the record variable Ptr^:

```
Ptr^ := My_Rec[Name: 'Kim Jones'; age: 65];
```

Pointers assume values through initialization, assignment, and the READ and NEW procedures. The value of a pointer is either the storage address of a dynamic variable or the predeclared identifier NIL. NIL indicates that the pointer does not currently refer to a dynamic variable.

A file referenced by a pointer is not closed until the execution of the program terminates or until the dynamic variable is deallocated with the DISPOSE procedure. [If you do not want the file to remain open throughout program execution, you must use the CLOSE procedure to close it.](#)

The following example declares the pointer variable Ptr as a pointer to an integer and initializes Ptr to NIL:

```
VAR
  Ptr : ^INTEGER VALUE NIL;
```

For performance reasons on VSI OpenVMS I64 systems, the VSI Pascal compiler assumes that all pointers point to objects that are aligned on at least octaword boundaries. The NEW predeclared routine always returns memory that is aligned on octaword boundaries.

For performance reasons on VSI OpenVMS Alpha systems, the VSI Pascal compiler assumes that all pointers point to objects that are aligned on at least quadword boundaries. The NEW predeclared routine always returns memory that is aligned on quadword boundaries.

For pointers holding addresses which are not quadword aligned, you can explicitly specify the expected alignment of the pointer base type. For example:

```
var
  p : ^ [aligned(0)] integer; { Pointer to a byte-aligned integer }
```

By default, all pointer types on VSI OpenVMS I64 and VSI OpenVMS Alpha systems are 32 bits. You can declare a 64-bit pointer by using the [QUAD] attribute in a pointer declaration. For example:

```
var
    long_ptr : ^integer;
    quad_ptr : [quad] ^integer;

begin
    new(long_ptr);
    quad_ptr := long_ptr;
    quad_ptr^ := 5;
    if quad_ptr <> long_ptr then quad_ptr := long_ptr;
end;
```

When comparing a 32-bit and a 64-bit pointer, the 32-bit pointer will be sign-extended before the comparison. Also, when assigning a 32-bit pointer value into a 64-bit pointer variable, the value will be sign-extended. You cannot assign a 64-bit pointer value into a 32-bit pointer variable.

For More Information:

- On the NEW procedure (Section 8.58)
- On the DISPOSE procedure (Section 8.28)
- On records (Section 2.4.2)
- On pointers to schema types (Section 2.5)
- On linked lists (*VSI Pascal for OpenVMS User Manual*)
- On compiler switches for selecting alignment, packing, and allocation rules for each platform (*VSI Pascal for OpenVMS User Manual*)

2.3.1. POINTER Type

The POINTER predefined type is compatible with all pointer types. Variables or functions of type POINTER cannot be dereferenced or used with the NEW and DISPOSE procedures. In order to access the data, you must assign the pointer value into a variable of a particular pointer type or typecast the pointer to a particular pointer type. For example, you can use the POINTER type in the following ways:

- To assign to or from any other type of pointer, including function result variables
- To compare equality with any other type of pointer
- To pass actual parameters of type POINTER to VAR and value parameters of any other type of pointer
- To accept parameters of any other type of pointer with formal parameters of type POINTER

2.4. Structured Types

The structured data types are user defined and consist of **components**. Each component of a structured data type has its own data type; components can be any type.

To express values of structured objects (arrays, records, and sets), you can use a list of values called **constructors**. Constructors are valid in the TYPE, CONST, VAR, and executable sections of your

program. Examples of valid constructors are provided throughout the following sections. The following sections also contain examples that show how to assign values to individual components of structured objects.

To save storage space, you can specify `PACKED` before any structured type identifier except `VARYING OF CHAR` (for example, `PACKED ARRAY`, `PACKED RECORD`, and `PACKED SET`). Defining `PACKED` structured types causes the compiler to economize storage by storing the structure in as few bits as possible. Keep in mind, however, that a packed data item is not compatible with a data item that is not packed. Also, accessing components of some packed structures can be slower than accessing components of unpacked structures.

VSI Pascal also provides the predefined structured type `TIMESTAMP` for more easily manipulating date and time information.

For More Information:

- On string data types (Section 2.6)
- On `VARYING OF CHAR` (Section 2.6.2)
- On array constructors (Section 2.4.1.2)
- On record constructors (Section 2.4.2.2)
- On set constructors (Section 2.4.3.1)
- On the `TIMESTAMP` type (Section 2.8)

2.4.1. ARRAY Types

An **array** is a group of components (called **elements**) that all have the same data type and share a common identifier. An individual element of an array is referred to by an ordinal index (or **subscript**) that designates the element's position (or order) in the array.

An array type has the following form:

```
[[PACKED]] ARRAY {[[attribute-list]] index-type}, ...] OF [[attribute-list]] component-type
```

`attribute-list`

One or more identifiers that provide additional information about the component type.

`index-type`

The type of the index, which can be any ordinal type or discriminated ordinal schema type.

`component-type`

The type of the array components, which can be any type. The components of an array can be another array.

The indexes of an array must be of an ordinal type. However, specifying large types, such as `INTEGER`, as the index type can cause the memory request to exceed available memory space. To use integer values as indexes, you must specify an integer subrange in the data type definition (unless you are using a conformant-array parameter).

You can use an array component anywhere in a program that a variable of the component type is allowed. Also, the only operation defined for entire array objects is the assignment operation (`:=`) (unless your array components are of a FILE type).

2.4.1.1. ARRAY Components

To refer to an array component, you specify the name of the array variable (or the name of an object whose result, when used as an expression, is of an array type), followed by an index value enclosed in brackets (`[]`). Consider the following:

```
TYPE
  Count = ARRAY[1..10] OF INTEGER;  {Array type of 10 integers}
VAR
  Numbers : Count;                  {Array variable}
{In the executable section:}
Numbers[5] := 18;  {Assigns the value 18 to the fifth element}
```

VSI Pascal also allows array components to be arrays. These types of arrays are called **multidimensional arrays**. The following example shows two ways of declaring the same multidimensional array:

```
VAR
  Tic_Tac_Toe : ARRAY[1..3] OF ARRAY['a'..'c'] OF CHAR;
  {Or equivalently:}
  Tic_Tac_Toe : ARRAY[1..3, 'a'..'c'] OF CHAR; {3x3 matrix}

{In the executable section:}
Tic_Tac_Toe[ 1, 'a' ] := 'X';  {Or equivalently:}
Tic_Tac_Toe[1][ 'a' ] := 'X';
```

For More Information:

- On character-string types (Section 2.6)
- On conformant-array parameters (Section 6.3.7.1)
- On attributes (Chapter 10)
- On the TEXT predefined data type (Section 2.4.5)

2.4.1.2. ARRAY Constructors

Array constructors are lists of values that you can use to specify an array value; they have the following form:

```
[[data-type]] [ [{{ {component-subrange} }, ... : component-value}; ... ] ]
  [[OTHERWISE component-value [[;]] ] ] ]
```

`data-type`

Specifies the constructor's data type. If you use the constructor in the executable section or in the CONST section, a data-type identifier is required. Do not use a type identifier in initial-state specifiers elsewhere in the declaration section or in nested constructors.

`component`

Specifies an element number to which the component-value applies. You can specify a subrange of components. Array elements do not have to be specified in order. The component must be a compile-time value or constant.

```
component-value
```

Specifies the value to be assigned to the array elements in the component list; the value must be of the same data type as the array-component type. This value is a compile-time value; if you use the constructor in the executable section, you can also use a run-time value.

```
OTHERWISE
```

Specifies a value to be assigned to all array elements that have not already been assigned values.

When using array constructors, you must initialize all elements of the array; you cannot partially initialize the array.

For example, you can use either of these constructors to assign values to the array variable:

```
VAR
  Numbers : Count VALUE [1..3,5 : 1; 4,6 : 2; 7..9 : 3; 10 : 6];
{In the executable section, constructor type is required:}
Numbers := Count[1..3,5 : 1; 4,6 : 2; 7..9 : 3; 10 : x+3];
```

These constructors give the first, second, third, and fifth component the value 1; the fourth and sixth component the value 2; and the seventh, eighth, and ninth components the value 3. The first constructor gives the tenth component the value 6; the second constructor, since it is in the executable section, can assign the run-time value $x+3$ to the tenth component.

To specify values for all remaining elements, you can use the `OTHERWISE` clause, as follows:

```
Numbers := Count[4,6 : 2; 7..9 : 3; 10 : x+3; OTHERWISE 1];
```

When you specify constructors for multidimensional arrays in the executable section, only specify the type of the outermost array. Consider the following example:

```
TYPE
  One_Dimension = ARRAY[1..3] OF CHAR;
  Matrix = ARRAY['a'..'b'] OF One_Dimension;
VAR
  Tic_Tac_Toe : Matrix;
{In the executable section:}
Tic_Tac_Toe := Matrix[ 1,3 : [OTHERWISE ' '];
                      2 : [ 1,3 : ' '; 2 : 'X']];
```

For More Information:

- On nonstandard array constructors (Section 2.4.6.1)

2.4.2. RECORD Types

A **record** is a group of components (called **fields**) that can be of various data types. Each record component can contain one or more data items, including embedded records. The record type has the following form:

```
[[PACKED]] RECORD [[field-list]] END
```

If field-list is not specified, an empty record is created. The syntax of field-list is as follows:

```
{{{field-identifier},... : [[attribute-list]] type};... [[; variant-  
clause]] [[;]]}  
{variant-clause [[;]]}
```

field-identifier

The name of a field.

attribute-list

One or more identifiers that provide additional information about the field.

type

The type of the corresponding field. A field can be of any type.

variant-clause

The variant part of the record.

The names of the fields must be unique within one record type, but can be repeated in different record types. You can specify the fields by specifying the record variable name (or the name of an object whose result, when used as an expression, is of a record type), followed by a period (.), and followed by the field name. If the record is unpacked, you can use a field anywhere in a program that a variable of the field type is allowed. (This manual flags circumstances in which components of packed records cannot appear where a variable of the field type is allowed.) The only operation defined for entire records is the assignment operation (:=).

The following example shows how to assign a value to a record component:

```
TYPE  
  Player_Rec = RECORD  
    Wins      : INTEGER;  
    Losses    : INTEGER;  
    Percentage : REAL;  
  END;  
VAR  
  Player1, Player2 : Player_Rec;  
{In the executable section:}  
Player1.Wins := 18; {Assigns the value 18 to the Wins field.}
```

You can partially initialize a record using the VALUE predeclared identifier on individual fields, as follows:

```
VAR  
  Player : RECORD  
    Wins      : INTEGER VALUE 18; {Initial value for one field}  
    Losses    : INTEGER;  
    Percentage : REAL;  
  END;
```

A record type can include fields that are themselves records. In this case, the name of the field includes the name of every record within which it is nested. Consider the following:

```
TYPE
```

```

Team_Rec = RECORD
  Total_Wins      : INTEGER;
  Total_Losses   : INTEGER;
  Total_Percentage : REAL;
  Player1        : Player_Rec;   {Defined in previous example}
  Player2        : Player_Rec;
  Player3        : Player_Rec;
END;
VAR
  Team : Team_Rec;

```

You can calculate the team's wins with the following code:

```

Team.Total_Wins := Team.Player1.Wins +
                  Team.Player2.Wins +
                  Team.Player3.Wins;

```

For More Information:

- On variant clauses (Section 2.4.2.1)
- On record constructors (Section 2.4.2.2)
- On specifying record fields using the WITH statement (Section 5.14)
- On attributes (Chapter 10)

2.4.2.1. Records with Variants

A record can include one or more fields or groups of fields called variants, which can contain different types or amounts of data at different times during program execution. When you use a record with variants, two variables of the same record type can represent different data. You can define a variant clause only for the last field in the record. The syntax for record variants is as follows:

```

    {[[tag-identifier : ]] [[attribute-list]] tag-type-identifier  }
CASE {discriminant-identifier                                     } OF
  {case-label-list : (field-list)};...
  [[ [[:]] OTHERWISE (field-list) ]]

```

tag-identifier

The name of the tag field.

attribute-list

One or more identifiers that provide additional information about the variant.

tag-type-identifier

The type identifier for the tag field.

discriminant-identifier

The name of the formal discriminant of a schema type. The value of the corresponding actual discriminant selects the active variant. Once you select the variant by discrimination, you cannot change it again. Consider the following:

```
TYPE
  Record_Template( a : INTEGER ) = RECORD
    Field_1 : REAL;
    CASE a OF
      0 : ( x : INTEGER );
      1 : ( y : REAL );
    END;
```

case-label-list

One or more case constant values of the tag field type separated by commas. A case constant is either a single constant value (for example, 1) or a range of values (for example, 5..10). You must enumerate one label for each possible value in the tag-type-identifier.

field-list

The names, types, and attributes of one or more fields. At the end of a field list, you can specify another variant clause. The field list can be empty.

The tag field consists of the elements between the reserved words CASE and OF. The tag field is common to all variants in the record type. The tag field data type corresponds to the case label values and determines the current variant.

As the syntax description shows, the tag field can be a discriminant-identifier or can be specified in one of the following ways:

- tag-identifier : [\[\[attribute-list\]\]](#)

The tag-identifier and tag-type-identifier define the name and type of the tag field. The tag-type-identifier must denote an ordinal type. You refer to the tag field in the same way that you refer to any other field in the record (with the record.field-identifier syntax).

The following example shows the use of the tag-identifier form:

```
TYPE
  Orders = RECORD
    Part : 1..9999;
    CASE On_Order : BOOLEAN OF
      TRUE  : ( Order_Quantity : INTEGER;
              Price           : REAL );
      FALSE : ( Rec_Quantity  : INTEGER;
              Cost            : REAL );
    END;
```

In this example, the last two fields in the record vary depending on whether the part is on order. Records for which the value of the tag-identifier On_Order is TRUE will contain information about the current order; those for which it is FALSE, about the previous shipment.

- [\[\[attribute-list\]\]](#)

In the second form, there is no tag-identifier you can evaluate to determine the current variant. If you use this form, you must keep track of the current variant yourself. The tag-type-identifier must denote an ordinal type.

The following example shows the specification of a tag field without a tag-identifier:

```
TYPE
  Characters = RECORD
  CASE CHAR OF
    'A'..'Z'   : ( Capital : INTEGER );
    '0'..'9'   : ( Number  : INTEGER );
    OTHERWISE  ( Misc     : BOOLEAN );
  END;
```

In this example, the last field in this record will be one of the following:

- The integer field `Capital` if the range `'A'..'Z'` is the variant most recently referred to
- The integer field `Number` if the range `'0'..'9'` is the variant most recently referred to
- The Boolean field `Misc` if the character value falls outside the previous two variants

You can refer only to the fields in the current variant. You should not change the variant while a reference exists to any field in the current variant.

You can include an `OTHERWISE` clause as the last case label list. `OTHERWISE` is equivalent to a case label list that contains tag values (if any) not previously used in the record. The variant labeled with `OTHERWISE` is the current variant when the tag-identifier has a value that does not occur in any of the case label lists.

The variant can contain a nested variant, as follows:

```
VAR
  Hospital : RECORD
  Patient   : Name;
  Birthdate : Date;
  Age       : INTEGER;
  CASE Pat_Sex : Sex OF
    Male     : ();
    Female   : ( CASE Births : BOOLEAN OF
                  FALSE     : ();
                  TRUE      : ( Num_Kids : INTEGER ));
  END;
```

This record includes a variant field for each woman based on whether she has children. A second variant, which contains the number of children, is defined for women who have children.

For More Information:

- On the syntax of a field list (Section 2.4.2)
- On conditions that establish a variable reference (Section 3.7)
- On attributes (Chapter 10)

2.4.2.2. Record Constructors

Record constructors are lists of values that you can use to initialize a record; they have the following form:

```
[[data-type]] [ [ [ [{{component}},... : component-value};... ] ]
  [ [ CASE [ [tag-identifier :]] tag-value OF
    [ [{{component}},... : component-value};... ] ] ] ] ] ]
```

```
[[ OTHERWISE ZERO [[;]] ]]
```

data-type

Specifies the constructor's data type. If you use the constructor in the executable section or in the CONST section, a data-type identifier is required. Do not use a type identifier in initial-state specifiers elsewhere in the declaration section or in nested constructors.

component

Specifies a field in the fixed-part of the record. Fields in the constructor do not have to appear in the same order as they do in the type definition. If you choose, you can specify fields from the variant-part as long as the fields do not overlap.

component-value

Specifies a value of the same data type as the component. The value is a compile-time value; if you use the constructor in the executable section, you can also use run-time values.

CASE

Provides a constructor for the variant portion of a record. If the record contains a variant, its constructor must be the last component in the constructor list.

tag-identifier

Specifies the tag-identifier of the variant portion of the record. This is only required if the variant part contained a tag-identifier.

tag-value

Determines which component list is applicable according to the variant portion of the record.

OTHERWISE ZERO

Sets all remaining components to their binary zero value. If you use OTHERWISE ZERO, it must be the last component in the constructor.

You can use either of the following constructors to assign values to the record variable:

VAR

```
Player1 : Player_Rec VALUE [Wins: 18; Losses: 3;
                             Percentage: 21/18];
{In executable section, constructor type is required
 and run-time expressions are legal;}
Player1 := Player_Rec[Wins: 18; Losses: y; Percentage: y+18/18];
```

When you specify constructors for records that nest records, specify the type of the outermost record, but do not specify the type of the constructors for any nested records. Consider the following example.

TYPE

```
Team_Rec = RECORD
  Total_Wins      : INTEGER;
  Total_Losses   : INTEGER;
  Total_Percentage : REAL;
  Player1        : Player_Rec;
  Player2        : Player_Rec;
```

```

Player3          : Player_Rec;
END;

```

```

VAR
  Team : Team_Rec;
{In the executable section: }
Team :=
  Team_Rec[Total_Wins: 18; Total_Losses: 3; Total_Percentage: 21/18;
           Player1: [Wins: 6; Losses: 0; Percentage: 1.0 ];
           Player2: [Wins: 5; Losses: 2; Percentage: 7/5 ];
           Player3: [Wins: 7; Losses: 1; Percentage: 8/7 ]];

```

You can call the ZERO function within record constructors to initialize all nonspecified components to their binary zero values, which are determined by the data type of each component. Consider the following examples:

```

VAR
  Team : Team_Rec VALUE ZERO ;
  Team : Team_Rec VALUE
    [Total_Wins: 5; Total_Losses: 2; Total_Percentage: 7/5;
     Player2: [Wins: 5; Losses: 2; Percentage: 7/5 ]];

```

OTHERWISE ZERO

```
]; {Initializes Player1 and Player3}
```

To create a constructor for a record that contains a variant, use the reserved word CASE, followed by one of the following:

- A tag-identifier and a colon (:), followed by a constant expression (if you use both a tag-identifier and a tag-type-identifier in the declaration)
- A constant expression (if you use only a discriminant-identifier or a tag-type-identifier in the declaration)

To complete the constructor, use the reserved word OF followed by component-list values contained in a nested constructor. Consider the following valid constructors.

```

TYPE
  Orders = RECORD
    Part : 1..9999;
    CASE On_Order : BOOLEAN OF
      TRUE  : ( Order_Quantity : INTEGER;
               Price          : REAL );
      FALSE : ( Rec_Quantity   : INTEGER;
               Cost           : REAL );
    END;
VAR
  An_Order : Orders VALUE
    [Part: 2358;
     CASE On_Order : FALSE OF
       [Rec_Quantity: 10; Cost: 293.99]];

{In the executable section, constructor type is required:}
An_Order := Orders
  [Part: 2358;

```

```
CASE On_Order : FALSE OF [Rec_Quantity: 10; Cost: 293.99]];
```

Note that if you use a constructor in the type definition, you can specify an initial state for only one variant in the type. To specify an initial state for more than one variant, you must put initial state specifiers on the fields themselves. For example:

```
TYPE
  Orders = RECORD
    Part : 1..9999 VALUE 25;
    CASE On_Order : BOOLEAN OF
      TRUE  : ( Order_Quantity : INTEGER VALUE 18;
               Price          : REAL VALUE 4.65 );
      FALSE : ( Rec_Quantity   : INTEGER VALUE 10;
               Cost           : REAL VALUE 46.50 );
    END;
END;
```

For More Information:

- On the ZERO function (Section 8.109)
- On nonstandard record constructors (Section 2.4.6.2)

2.4.3. SET Type

A **set** is a collection of data items of the same ordinal type (called the **base type**). The SET type definition specifies the values that can be elements of a variable of that type. The SET type has the following form:

```
[[PACKED]] SET OF [[attribute-list]]
```

attribute-list

One or more identifiers that provide additional information about the base-type.

base-type

The ordinal type identifier or type definition, or discriminated schema type, from which the set elements are selected. Real numbers cannot be elements of a set type.

You define a set by listing all the values that can be its elements. A set whose base type is integer or unsigned has two restrictions. First, the set can not contain more than 256 elements. Second, the ordinal value of the elements in a set must be within the range of 0 and 255.

For sets of other ordinal base types, elements can include the full range of the type.

The INTSET predefined type is equivalent to:

```
TYPE INTSET = SET OF 0 .. 255;
```

For More Information:

- On the INTEGER type (Section 2.1.1.1)
- On the UNSIGNED type (Section 2.1.1.2)
- On the subrange type (Section 2.1.5)

- On attributes (Chapter 10)
- On schema discriminants in sets (Section 2.5)

2.4.3.1. Set Constructors

Set constructors are lists of values that you can use to initialize a set; they have the following form:

```
[[data-type]] [ [{component-value}, ... ] ]
```

data-type

The data type of the constructor. This identifier is optional when used in the CONST and executable sections; do not use this identifier in the TYPE and VAR sections or in nested constructors.

component-value

Specifies values within the range of the defined data type. Component values can be subranges (..) to indicate consecutive values that appear in the set definition. These values are compile-time values; if you use the constructor in the executable section, you can also use run-time values.

A set having no elements is called an empty set and is written as empty brackets ([]).

A possible constructor for a variable of type SET OF 35..115 is the following:

```
VAR
  Numbers : SET OF 35..115 VALUE [39, 67, 110..115];
{In the executable section, run-time expressions are legal:}
Numbers := [39, 67, x+95, 110..115];
```

The set constructors contain up to nine values: 39, 67, x+95 (in the executable section only), and all the integers between 110 and 115, inclusive. If the expression x+95 evaluates to an integer outside of the range 35..115, then Pascal includes no set element for that expression.

To initialize a set to the empty set, do the following:

```
VAR
  Day : SET OF 1..31 VALUE [];
```

2.4.4. FILE Type

A **file** is a sequence of components of the same type. The number of components is not fixed; a file can be of any length. The FILE type definition identifies the component type and has the following form:

```
[[PACKED]] FILE OF [[attribute-list]] component-type
```

attribute-list

One or more identifiers that provide additional information about the file components.

component-type

The type of the file components. This type can be any ordinal, real, pointer, or structured type except for the following:

- [Nonstatic type](#)
- [Structured type with a nonstatic component](#)
- File type
- Structured type with a file component

The arithmetic, relational, Boolean, and assignment operators cannot be used with file variables or structures containing file components. You cannot form constructors of file types.

When you declare a file variable in your program, VSI Pascal automatically creates a file buffer variable of the component type. This variable takes on the value of one file component at a time.

To reference the file buffer variable, write the name of the associated file variable, followed by a circumflex (^). No operations can be performed on the file while a reference to the file buffer variable exists.

The following example shows two ways to declare files:

```
VAR
  True_False_File : FILE OF BOOLEAN;      {File of TRUE and FALSE values}
  Experiment_Records : FILE OF RECORD    {File of records}
      Trial : INTEGER; {To access,
Experiment_Records^.Trial}
      Temp, Pressure : INTEGER;
      Yield, Purity : REAL;
END;
```

For More Information:

- On file organization (Section 9.1)
- On component formats (Section 9.2)
- On conditions that establish a variable reference (Section 3.7)
- On attributes (Chapter 10)

2.4.5. TEXT Type

The TEXT predefined type is a file containing sequences of characters with special markers (end-of-line and end-of-file) added to the file. Although each character of a TEXT file is one file component, the end-of-line marker allows you to process the file line by line, if you choose. The TEXT type has the following form:

```
[[attribute-list]] TEXT
```

[attribute-list](#)

[One or more identifiers that provide additional information about the file components.](#)

For More Information:

- On the FILE type (Section 2.4.4)

- On TEXT files (Section 9.5)
- On INPUT, OUTPUT, and ERR identifiers (Section 9.5)

2.4.6. Nonstandard Constructors

As an option, you can use another format for constructors that is provided as an VSI Pascal extension. VSI Pascal retains this format only for compatibility with programs written for use with previous versions of this product. Also, you cannot use nonstandard constructors for variables of nonstatic types.

For all nonstandard constructors, you place constant values, of the same type as the corresponding component, in a comma list within parentheses. The compiler matches the values with the components using positional syntax; you must provide a value for each component in the variable. Nested structured components are designated by another comma list inside of another set of parentheses. Nonstandard constructors are legal in the VAR and VALUE initialization sections, and in the executable section. Specifying a type identifier as part of a constructor is optional for constructors used in the VAR and VALUE initialization sections, are required for constructors in the executable section, and cannot be used for nested constructors.

For More Information:

- On Pascal standards (Section 1.1)
- On standard constructors (Section 2.4)

2.4.6.1. Nonstandard Array Constructors

The format for nonstandard array constructors is as follows:

```
[[data-type]] ( [[{component-value},... ]] [[ REPEAT component-  
value ]] )
```

data-type

Specifies the constructor's data type. If you use the constructor in the executable section, a data-type identifier is required. Do not use a type identifier in the VAR or VALUE sections or for a nested constructor.

component-value

Specifies the compile-time value to be assigned to the corresponding array element. The compiler assigns the first value to the first element, the second value to the second element, and so forth. If you want to assign more than one value to more than one consecutive element, you can use the following syntax for a component-value:

n OF value

For example, the following component value assigns the value of 15 to the first three components of an array:

```
VAR  
  Array1 : ARRAY[1..4] OF INTEGER;  
VALUE  
  Array1 := ( 3 OF 15, 78 );
```

You cannot use the OF reserved word in a REPEAT clause.

REPEAT

Specifies a value to be assigned to all array elements that have not already been assigned values.

An example of an array constructor is as follows:

```
TYPE
  Count = ARRAY[1..10] OF INTEGER;
VAR
  Numbers : Count;
VALUE
  Count := ( 3 OF 1, 2, 1, 2, 3 OF 3, 3 );
{In the executable section, constructor type is required;}
Numbers := Count( 3 OF 1, 2, 1, 2, REPEAT 3 );
```

An example of a constructor for a multidimensional array is as follows:

```
TYPE
  One_Dimension = ARRAY[1..3] OF CHAR;
  Matrix = ARRAY['a'..'b'] OF One_Dimension;
VAR
  Tic_Tac_Toe : Matrix;
  { In the executable section: }
Tic_Tac_Toe := Matrix( (3 OF ' '), (' ', 'X', ' '), (3 OF ' ') );
```

For More Information:

On standard array constructors (Section 2.4.1.2)

2.4.6.2. Nonstandard Record Constructors

The format for a nonstandard record constructor is as follows:

```
[[data-type]] ( [[{component-value},... ]] [[ tag-value, {component-  
value};... ]] )
```

data-type

Specifies the constructor's data type. If you use the constructor in the executable section, a data-type identifier is required. Do not use a type identifier in the VAR or VALUE sections or for a nested constructor.

component-value

Specifies a compile-time value of the same data type as the component. The compiler assigns the first value to the first record component, the second value to the second record component, and so forth.

tag-value

Specifies a value for the tag-identifier of a variant record component. The value that you specify as this component of the constructor determines the types and positions of the remaining component values (according to the variant portion of the type definition).

An example of a record constructor is as follows:

```
TYPE
  Player_Rec = RECORD
    Wins      : INTEGER;
```

```
    Losses      : INTEGER;
    Percentage  : REAL;
VAR
    Player1 : Player_Rec := ( 18, 6, 24/18 );
{In the executable section, constructor type is required;}
Player1 := Player_Rec( 18, 6, 24/18 );
```

The following is an example of a nested record constructor:

```
TYPE
    Team_Rec = RECORD
        Total_Wins      : INTEGER;
        Total_Losses    : INTEGER;
        Total_Percentage : REAL;
        Player1         : Player_Rec;
        Player2         : Player_Rec;
        Player3         : Player_Rec;
    END;
VAR
    Team : Team_Rec;
{In the executable section: }
Team := Team_Rec ( 18, 3, 18/21,
                  ( 6, 0, 1.0 ),
                  ( 5, 2, 5/7 ),
                  ( 7, 1, 7/8 ) );
```

The following is an example of a variant record constructor:

```
TYPE
    Orders = RECORD
        Part : 1..9999;
        CASE On_Order : BOOLEAN OF
            TRUE  : ( Order_Quantity : INTEGER;
                    Price           : REAL );
            FALSE : ( Rec_Quantity   : INTEGER;
                    Cost            : REAL );
        END;
VAR
    An_order : Orders := ( 2358, FALSE, 10, 293.99 );
```

For More Information:

- On standard record constructors (Section 2.4.2.2)
- On record variants (Section 2.4.2.1)

2.5. Schema Types

A **schema type** is a user-defined construct that provides a template for a family of distinct data types. A schema type definition contains one or more **formal discriminants** that take the place of specific boundary values or variant-record selectors. By specifying boundary or selector values to a schema type, you form a valid data type; the provided boundary or selector values are called **actual discriminants**. Schema types have the following form:

```
schema-identifier ({{discriminant-identifier}},... :
    [[attribute-list]] ordinal-type-name};... )
= [[attribute-list]] type-denoter;
```

schema-identifier

The name of the schema.

discriminant-identifier

The name of a formal discriminant.

attribute-list

One or more identifiers that provide additional information about the type-denoter.

ordinal-type-name

The type of the formal discriminant, which must be an ordinal type (except those types that have INTEGER64 or UNSIGNED64 base types).

type-denoter

The type definition of the components of the schema. This must define a new record, array, set, or subrange type.

Each schema type definition requires at least one discriminant identifier. A discriminant identifier does not have to be used in the type-denoter definition, but Pascal still uses the discriminant identifier to determine type compatibility. Discriminant-identifiers can appear anywhere a value is required in this definition. Consider the following example:

```
TYPE
  Array_Template( Upper_Bound : INTEGER )
    = ARRAY[1..Upper_Bound] OF INTEGER;
```

The identifier `Upper_Bound` is the formal discriminant of the `Array_Template` schema. The `Array_Template` schema is not a complete description of data. It is not a valid data type until you provide an actual discriminant that designates the upper boundary of the array template. Schema types that have not been provided actual discriminants are called **undiscriminated schema**; in the previous example, `Array_Template` is an undiscriminated schema. You can use an undiscriminated schema in the following instances:

- As the domain type of a pointer
- As the type of a formal parameter

In an undiscriminated schema declaration, you can use a combination of formal discriminants, compile-time values, and nested discriminants to form subrange bounds. These types of expressions are called **nonvarying expressions**. Consider the following:

```
TYPE
  Vector( d : INTEGER ) = ARRAY[0..d-1] OF BOOLEAN;
  Number_Line( Starting, Distance : INTEGER ) =
    Starting..Starting+Distance;
  My_Subrange( l, u : INTEGER ) = l..u;
  Shift_Array_Index( l2, u2, Length : INTEGER ) =
    ARRAY[My_Subrange( l2+10, u2+10 )] OF STRING( Length );
```

The following example provides the `Array_Template` schema with actual discriminants to form complete data types (the remaining examples in this section use the `Array_Template` declaration).

```
TYPE
```

```

Array_Template( Upper_Bound : INTEGER )
    = ARRAY[1..Upper_Bound] OF INTEGER;
VAR
Array1 : Array_Template( 10 ); {ARRAY[1..10] OF INTEGER;}
Array2 : Array_Template( x );  {Upper boundary determined at
                                run time by variable or
                                function call}

```

In the previous example, the actual discriminants 10 and x complete the boundaries for `Array_Template`, forming two complete data types within the same schema type family. A schema type that has been provided actual discriminants is called a **discriminated schema**; discriminated schema can appear in either the `TYPE` or `VAR` sections. The type specifiers `Array_Template(10)` and `Array_Template(x)` are examples of discriminated schema.

Actual discriminants can be compile- or run-time expressions. This expression must be assignment compatible with the ordinal type specified for the formal discriminant. Also, the actual discriminant value must be inside the range specified for the formal discriminant; in the case of subranges, the upper value must be greater than or equal to the lower value. In the previous example, 10 and x must be within the range `-MAXINT..MAXINT`.

If you want to use a discriminated schema type as the domain type of a pointer or as the type of a formal parameter, give the discriminated schema type a name by declaring it in the `TYPE` section. Consider the following:

```

TYPE
    Array_Type1 = Array_Template( 10 );

PROCEDURE Example( Param : Array_Type1 ); {Procedure body...}

```

For any undiscriminated schema, there is a range of possible data types that you can form by discrimination. A **schema family** is the undiscriminated schema type and the range of data types that can be formed from it. Also, two separate discriminations that provide the same actual discriminant value specify the same data type. Consider the following.

```

TYPE
    My_Subrange( a, b : INTEGER ) = a..b;
    Sub_A = My_Subrange( 1, 5 );
    Sub_B = My_Subrange( 1, 5 );
    Sub_C = My_Subrange( -50, 50 );

```

The types `Sub_A`, `Sub_B`, and `Sub_C` are all of the `My_Subrange` schema-type family. `Sub_A` and `Sub_B` are of the same data type. Consider the following.

```

TYPE
    My_Subrange( a, b : INTEGER ) = a..b;
    My_Array( Upper : INTEGER ) = ARRAY[1..Upper] OF INTEGER;
VAR
    i : My_Array( 10 );
    j : My_Array( 10 );
    k : My_Array( 15 );
    l : ARRAY[ My_Subrange( 1, 10 ) ] OF INTEGER;
    m : ARRAY[ My_Subrange( 1, 10 ) ] OF INTEGER;

```

```

{In the executable section:}
i := j;      {Legal; same schema family, same actual discriminant}
i := k;      {Illegal; same schema family, different actual}
i := l;      {Illegal; different types}

```

```
l := m;          {Illegal; different types}
```

Types l and m are not assignment compatible despite having the same subrange values specified by the same schema type; the two distinct type declarations create two distinct types, regardless of the ranges of the two types.

Once you create a discriminated schema, you can access the value of an actual discriminant. Consider the following example:

```
VAR
  Array1 : Array_Template( 10 );
{In the executable section:}
WRITELN( Array1.Upper_Bound );    {Writes 10 to the default device}
```

Discriminant values can appear in all expressions except constant expressions. The following example shows a valid use of the discriminant-value expression:

```
FOR i := 1 TO Array1.Upper_Bound DO
  Array1[i] := i;
```

You can use discriminated schema in the type-denoter of a schema definition. You can also discriminate a schema in the type-denoter of a schema definition, but the actual discriminants must be expressions whose values are nonvarying; the actual discriminants cannot be variables or function calls.

Consider the following valid schema definitions:

```
TYPE
  { Legal schema types:      }
  Range1( a, b : INTEGER ) = SET OF a..b+1;  {Run-time bounds checking}

  My_Record( Number_Size, Status_Size : INTEGER ) = RECORD
    Part_Number : PACKED ARRAY[1..Number_Size] OF INTEGER;
    Status      : STRING( Status_Size );      {Nested schema}
  END;

  Range2( Low, Span : INTEGER ) = Low..Low + Span;
  My_Integer( Dummy : INTEGER ) = -MAXINT-1..MAXINT;
  Matrix( Bound : INTEGER ) = ARRAY[1..Bound, 1..Bound] OF REAL;

  { Illegal schema types (they do not form "new" types):  }
  My_String( Len : INTEGER ) = VARYING[Len] OF CHAR;
  My_Integer( Dummy : INTEGER ) = INTEGER;
```

2.6. String Types

You can use schema and data types to store and to manipulate character strings. These types have the following order of complexity:

1. CHAR type
2. PACKED ARRAY OF CHAR user-defined types
3. [VARYING OF CHAR user-defined types](#)
4. STRING predefined schema

Objects of the CHAR data type are character strings with a length of 1 and are lowest in the order of character string complexity. You can assign CHAR data to variables of the other string types.

The PACKED ARRAY OF CHAR types allow you to specify fixed-length character strings. [The VARYING OF CHAR types](#) are a VSI Pascal extension that allows you to specify varying-length character strings with a constant maximum length. The STRING types provide a standard way for you to specify storage for varying-length character strings with a maximum length that can be specified at run time.

To provide values for variables of these types, you should use a character-string constant (or an expression that evaluates to a character string) instead of an array constructor. Using array constructors with STRING and [VARYING OF CHAR](#) types generates an error; to use array constructors with PACKED ARRAY OF CHAR types, you must specify component values for every element in the array (otherwise, you generate an error).

Consider the following example:

```
VAR
  String1 :
    VARYING[10] OF CHAR
```

Generally, you can use any member of the ASCII character set in character-string constants and expressions. However, some members of the ASCII character set, including the bell, the backspace, and the carriage return, are nonprinting characters. [The extended string format for character strings with nonprinting characters](#) is as follows:

```
{'printing-string' ({ordinal-value}, ...)}...
printing-string
```

A character-string constant.

Consider the following example:

```
Two bells'(7,7)' in a null-terminated ASCII string.'(0)
```

VSI Pascal provides the substring access notation to denote a piece of a string variable, string constant, or string function. The lower-bound and upper-bound are index-expressions. Consider the following:

```
string-access "[" lower-bound ".." upper-bound "]"
```

The following is an example:

```
var s : packed array [1..10] of char;

s[1..5] := 'hello';
s[6..10] := 'world';
```

In the executable-section of a block, these lower and upper bound expressions can be run-time expressions and are checked for validity if compiled with checking code enabled. You can also pass these string pieces to VAR parameters. For example:

```
procedure do_buf(var p : packed array [1..u:integer] of char);
  begin p := '12345'; end;

var buff : packed array [1..10] of char;
```

```
do_buff(buff[1..5]);
do_buff(buff[6..10]);

writeln(buff);
```

To avoid compile-time warning messages about passing components of PACKED structures to VAR parameters, use /USAGE=NOPACKED_ACTUALS to compile.

In expressions, substring access behaves much like the SUBSTR built-in.

VSI Pascal also provides features for handling null-terminated strings. These are useful for communicating with routines written in the C language and on UNIX systems.

For More Information:

- On the CHAR data type (Section 2.1.2)
- On the ASCII character set (Section 1.2.1)
- On null-terminated strings (Section 2.7)

2.6.1. PACKED ARRAY OF CHAR Types

User-defined packed arrays of characters with specific lower and upper bounds provide a method of specifying fixed-length character strings. The string's lower bound must equal 1. The upper bound establishes the fixed length of the string.

The following example shows a declaration of a character string variable of twenty characters:

```
VAR
  My_String : PACKED ARRAY[1..20] OF CHAR;
```

Note

If the upper bound of the array exceeds 65,535, if the PACKED reserved word is not used, or if the array's components are not byte-sized characters, the compiler does not treat the array as a character string.

To assign values to fixed-length character strings, you can use a character-string constant (or an expression that evaluates to a character string). When assigning into fixed-length strings, the compiler adds blanks to extend a string shorter than the maximum characters declared. If you specify a string longer than the maximum characters declared, an error occurs. You can also use an array constructor as long as you specify characters for every component of the array as specified in the declaration. Consider the following example:

```
VAR
  States : PACKED ARRAY[1..20] OF CHAR
    VALUE 'Hello';                                {Is legal}
  States : PACKED ARRAY[1..20] OF CHAR
    VALUE [1:'H';2:'e';3:'l';4:'l';5:'o']         {Generates
                                                    an error}
  States : PACKED ARRAY[1..20] OF CHAR
    VALUE [1:'H';2:'e';3:'l';4:'l';5:'o';
          OTHERWISE ' ']                          {Is legal,
```

```
but awkward}
```

For More Information:

- On arrays (Section 2.4.1)

2.6.2. VARYING OF CHAR Types

The VARYING OF CHAR user-defined types are an VSI Pascal extension that provides a way of declaring variable-length character strings with a constant maximum length. If you require portable code, use the STRING predefined schema types to specify variable-length character strings.

VARYING OF CHAR types have the following form:

```
VARYING [upper-bound] OF [[attribute-list]] CHAR
```

upper-bound

An integer in the range from 1 through 65,535 that indicates the length of the longest possible string.

attribute-list

One or more identifiers that provide additional information about the VARYING OF CHAR string component.

You can assign string constants to VARYING OF CHAR variables from length 0 to the specified upper-bound. The compiler allocates enough storage space to hold a string of the maximum length. A VARYING OF CHAR variable with length 0 is the empty string (' '). You can only use character-string constants (or expressions that evaluate to character strings) to assign values to variables of these types; you cannot use standard array constructors. Also, you can initialize a character string to the empty string (' '), as follows:

```
VAR
  String1 : VARYING[10] OF CHAR VALUE '';
```

The VARYING OF CHAR variable is stored as though it were a record with two fields, as follows:

```
RECORD
  LENGTH   : [WORD] 0..upper-bound; {Length of current string}
  BODY     : PACKED ARRAY[1..upper-bound] OF CHAR; {Current string}
END;
```

You can access the LENGTH and BODY predeclared identifiers as you would access fields of a record. For example, to determine the maximum length of a VARYING OF CHAR variable, use the SIZE predeclared function and the BODY predeclared identifier, as follows:

```
VAR
  String1 : VARYING[10] OF CHAR VALUE 'Wolf';
{In the executable section: }
Max_Length := SIZE( string1.BODY );
WRITELN( Max_Length );           {writes '10'}
```

To determine the current length of a VARYING OF CHAR variable, use the LENGTH predeclared function. From the previous example, the result of LENGTH(String1) is the same as String1.LENGTH.

You can refer to individual array components as you would individual components of any array, as follows:

```
String1[8] := 'L';
```

You cannot specify an index value that is greater than the length of the current string. VSI Pascal does not pad remaining characters in the current string with blanks (' '). If you specify an index that is greater than the current length of the string, an error occurs.

For More Information:

- On arrays (Section 2.4.1)
- On attributes (Chapter 10)
- On the `SIZE` predeclared function (Section 8.81)
- On the `LENGTH` predeclared function (Section 8.49)

2.6.3. STRING Schema Type

The `STRING` predefined schema provides a way of declaring variable-length character strings. The compiler stores `STRING` data as though it were stored in the following schema definition:

```
TYPE
  STRING( capacity : INTEGER ) = VARYING[capacity] OF CHAR;
```

The syntax of the discriminated schema is as follows:

```
STRING( capacity )
```

[capacity]

An integer in the range 1..65,535 that indicates the length of the longest possible string.

To use the predefined `STRING` schema, you provide an upper bound as the actual discriminant, as in the following example:

```
VAR
  Short_String : STRING( 5 );      {Maximum length of 5 characters}
  Long_String  : STRING( 100 );   {Maximum length of 100 characters}
```

You can assign string constants to `STRING` variables from length 0 to the specified upper bound. The compiler allocates enough storage space to hold a string of the maximum length. A `STRING` variable with length 0 is the empty string (' '). To provide values for variables of this type, you must use character-string constants (or expressions that evaluate to character strings); you cannot use array constructors. Also, you can initialize a character string to the empty string (' '), as follows:

```
VAR
  Short_String : STRING( 5 ) VALUE '';
```

You can access the `CAPACITY` predeclared identifier as you would a schema discriminant, and you can access the `LENGTH` and `BODY` predeclared identifiers as you would access fields of a record. The `CAPACITY` identifier allows you to access the actual discriminant of the `STRING` schema; the `LENGTH` identifier allows you to access the current length of the string object; and the `BODY` identifier contains the current string object, including whatever is in memory up to the capacity of the discriminated schema, as shown in the following example:

```
VAR
  String1 : STRING( 10 ) VALUE 'Wolf';
```

```
{In the executable section: }  
WRITELN( String1.CAPACITY ); {prints '10'}  
WRITELN(
```

```
String1.LENGTH
```

```
{prints '4'}
```

The value `String1.BODY` contains the four-character string 'Wolf' followed by whatever is currently stored in memory for the remaining six characters.

To determine the current length of a `STRING` variable, you can use the `LENGTH` predeclared function. The result of `LENGTH(String1)` is the same as `String1.LENGTH`.

You can refer to individual `STRING` components as you would individual components of any array, as follows:

```
String1[5] := 't';
```

The compiler does not pad remaining characters in the current string with blanks (' '). If you specify an index that is greater than the current length of the string an error occurs. Consider the following example:

```
VAR  
  String1 : STRING( 10 ) VALUE 'Wombat';  
  x       : CHAR;  
{In the executable section:}  
x := String1[9];      {Generates an error}  
x := String1.BODY[9]; {Provides whatever is in memory there}  
x := String1[5];     {Is legal}  
String1[9] := 'X';   {Generates an error}
```

For More Information:

- On schema types (Section 2.5)
- On arrays (Section 2.4.1)
- On the `SIZE` predeclared function (Section 8.81)

2.7. Null-Terminated Strings

VSI Pascal includes routines and a built-in type to better coexist with null-terminated strings in the C language.

The `C_STR_T` datatype is equivalent to:

```
C_STR_T = ^ ARRAY [0..0] OF CHAR;
```

`C_STR_T` is a pointer to an `ARRAY OF CHARs`. It does not allocate memory for any character data. `C_STR_T` behaves like a normal pointer type in that you can assign `NIL` into it and the optional pointer checking code will check for dereferencing of a `NIL` pointer. The individual characters can be used by dereferencing the pointer and using an array index.

In these cases, no bounds checking will be performed even if array bounds checking is enabled. However, you cannot dereference a `C_STR_T` pointer without also indexing a single character. If you want to access an entire null-terminated string, see the `PAS_STR` function.

For More Information:

- On the MALLOC_C_STR function (Section 8.54)
- On the C_STR function (Section 8.16)
- On the PAS_STRCPY function (Section 8.66)
- On the PAS_STR function (Section 8.67)

2.8. TIMESTAMP Type

The `TIMESTAMP` predefined type is used in conjunction with the `GETTIMESTAMP` procedure and with the `DATE` or `TIME` functions. `GETTIMESTAMP` initializes a variable of type `TIMESTAMP`; `DATE` and `TIME` function parameters are of type `TIMESTAMP`.

The `TIMESTAMP` data type is similar to the following record definition:

```
TIMESTAMP = PACKED RECORD
  DATEVALID, TIMEVALID   : BOOLEAN;
  YEAR                   : INTEGER;
  MONTH                  : 1..12;
  DAY                    : 1..31;
  HOUR                   : 0..23;
  MINUTE                 : 0..59;
  SECOND                 : 0..59;

  { The last 3 fields are OpenVMS systems only. }
  HUNDREDTH              : 0..99;
  BINARY_TIME            : [QUAD] RECORD L1,L2:INTEGER END;
                        {64-bit VMS binary time;}
  DAY_OF_WEEK            : 1..7;   {1 is Monday and 7 is Sunday}

END;
```

For More Information:

- On the `GETTIMESTAMP` procedure (Section 8.38)
- On the `DATE` and `TIME` functions (Section 8.23)

2.9. Static and Nonstatic Types

Static types are types whose objects can be fully described at compile time. For example, the variables `a` and `b` are derived from static types in the following example:

```

VAR
  a : INTEGER;
  b : ARRAY[1..10] OF INTEGER;

```

Nonstatic types are types whose objects potentially cannot be fully described at compile time (the type has a component that can be a run-time value). Nonstatic types include the following types:

- Discriminated and undiscriminated schema types
- Any type that contains a nonstatic component or index type

Nonstatic types require storage allocation to hold information about the type at run time. This storage, called the **control part**, includes information that cannot be determined until execution time; VSI Pascal needs this information to allocate and to access variables and record fields of this type.

Consider the following nonstatic types:

```

TYPE
                                {Template is nonstatic;}
Template( Upper : INTEGER ) = ARRAY[1..Upper] OF INTEGER;
a = ^Template;                {a's base type is nonstatic}
b = Template( 5 );           {b is nonstatic}
My_Subrange( x, y : INTEGER ) = x..y;
                                {c is nonstatic;}
c = ARRAY[My_Subrange( j, k ), My_Subrange( l, m )] OF INTEGER;
d = ARRAY[1..10] OF Template( 5 ); {d is nonstatic}
e = RECORD                    {e is nonstatic}
  f1 : TEMPLATE( 5 );
END;
f = SET OF My_Subrange( 10, 20 ); {f is nonstatic}

```

Do not confuse static and nonstatic types with automatic and static variable allocation.

For More Information:

- On automatic variable allocation (Section 10.2.5)
- On static variable allocation (Section 10.2.36)
- On storage representation of nonstatic types (Section A.3.3)

2.10. Type Compatibility

The following sections discuss the two forms of type compatibility: structural and assignment compatibility.

2.10.1. Structural Compatibility

Two types are structurally compatible only if they have the same allocation size and the same type structure. VSI Pascal requires that the type of a variable passed to a routine as an actual parameter be structurally compatible with the type of the corresponding formal variable parameter. VSI Pascal also checks the structural compatibility of the base types when a pointer expression is assigned to a pointer variable. Structural compatibility does not apply to nonstatic types (schema types and types derived from schema types).

Two ordinal types are structurally compatible only if they have the same base type and the same allocation size.

If two ordinal types are components of packed structured types, they are structurally compatible only if the ranges of values they describe have identical upper and lower bounds.

In general, each real type is structurally compatible only with itself. However, because REAL and SINGLE are synonymous, they are structurally compatible with each other.

For two structured types to be structurally compatible, they must have the same allocation size, and both must be packed or both unpacked. The following conditions also affect structural compatibility:

- If both types are record types, they must have the same number of fields, and the types of corresponding fields must be structurally compatible and identically positioned. If the record types have variant parts, the corresponding variants must have identical case labels written in the same order. The types of the fields within corresponding variants must be structurally compatible.
- If both types are array types, the types of their components must be structurally compatible. The index types must have identical base types and identical upper and lower bounds.
- If both types are VARYING OF CHAR types, their maximum lengths must be equal. The lengths of the current values of the VARYING OF CHAR strings do not affect structural compatibility.
- If two components of packed structured types are set types, their base types must have identical upper and lower bounds.
- If both types are set types, file types, or pointer types, their base types must be structurally compatible. Because of the possibility that a pointer type can be defined in terms of itself, the VSI Pascal compiler begins the test for the structural compatibility of two pointer types by assuming that they are compatible. Next, the compiler tests the two base types for structural compatibility. If within the base type, the compiler encounters the same pointer types it is testing, it still follows the original assumption that the pointer types are compatible. If the base types prove to be structurally compatible, then the two pointer types are judged to be structurally compatible.

For More Information:

- On attributes that affect size and structure: ALIGNED, POS, READONLY, UNALIGNED, UNSAFE, VOLATILE, and WRITEONLY (Chapter 10)
- On ordinal types (Section 2.1)
- On real types (Section 2.2)
- On pointer types (Section 2.3)
- On structured types (Section 2.4)
- On allocation sizes of objects (Section A.2.4)

2.10.2. Assignment Compatibility

Assignment compatibility rules apply to the types of values used to initialize variables, the types of expressions assigned to variables with the assignment operator (:=), and the types of actual parameters passed to formal value parameters. A variable or formal parameter is always compatible with expressions of its type.

Table 2.10 shows the contexts in which the type of an expression is assignment compatible with the type of a variable or a formal parameter when the types are not the same.

Table 2.10. Assignment Compatibility

Type of Variable	Type of Assignment-Compatible Expression or Parameter
INTEGER	INTEGER, UNSIGNED, INTEGER64, UNSIGNED64
UNSIGNED	INTEGER, UNSIGNED, INTEGER64, UNSIGNED64
INTEGER64	INTEGER, UNSIGNED, INTEGER64, UNSIGNED64
UNSIGNED64	INTEGER, UNSIGNED, INTEGER64, UNSIGNED64
Subrange	Base type of the subrange
REAL, SINGLE	REAL, SINGLE, UNSIGNED, INTEGER, INTEGER64, UNSIGNED64
DOUBLE	DOUBLE, REAL, SINGLE, UNSIGNED, INTEGER, INTEGER64, UNSIGNED64
QUADRUPLE	QUADRUPLE, DOUBLE, REAL, SINGLE, UNSIGNED, INTEGER
PACKED ARRAY OF CHAR	CHAR, unpacked array of CHAR, PACKED ARRAY OF CHAR with the same or smaller length, VARYING or STRING string whose current length is equal to or less than the packed array
VARYING OF CHAR	CHAR, unpacked array of CHAR, PACKED ARRAY OF CHAR, VARYING, STRING, string whose current value does not exceed the maximum length of the variable or parameter
STRING	CHAR, unpacked array of CHAR, PACKED ARRAY OF CHAR, VARYING, STRING, string whose current value does not exceed the maximum length of the variable or parameter
Pointer	Pointer to a structurally compatible type

Two record types or two array types are assignment compatible if they are structurally compatible. When you assign one record variable to another, or one array variable to another, the VSI Pascal compiler does not check for out-of-range assignments to record fields or array components; such assignments do not result in an error message, even if subrange checking is enabled at compile time.

A set expression is assignment compatible with a set variable if the set's base types are compatible. In addition, all elements of the set expression must be included in the range of the variable's base type.

Note that assignment operations are not allowed on objects of file types or structured types that have file components.

Two discriminated schema types are assignment compatible if they are of the same type family and if their actual discriminant values are identical. A dereferenced pointer to an undiscriminated schema type is actually referencing a discriminated schema object whose discriminants were specified in a call to the NEW function. Although STRING is a schema, the rules in Table 2.10 take precedence.

For More Information:

- On ordinal types (Section 2.1)
- On real types (Section 2.2)

- On pointer types (Section 2.3)
- On structured types (Section 2.4)
- On schema types (Section 2.5)
- On string types (Section 2.6)
- On attributes that affect assignment compatibility: POS, READONLY, and UNSAFE (Chapter 10)

Chapter 3. Declaration Section

The declaration section contains declarations or definitions of constants, labels, user-defined data types, variables, and user-defined functions and procedures. In addition, only modules can contain initialization and finalization sections. Each appears in a subsection introduced by Pascal reserved words.

This chapter discusses the following topics:

- Section 3.1: CONST Section
- Section 3.2: LABEL Section
- Section 3.3: TO BEGIN DO Section
- Section 3.4: TO END DO Section
- Section 3.5: TYPE Section
- Section 3.6: VALUE Section
- Section 3.7: VAR Section

These sections appear after the header and before the executable section (if any). The TO BEGIN DO and TO END DO sections can appear only in modules and only once within a module.

The remaining sections can appear in programs, modules, functions, or procedures; they can appear more than once and in any order in a single declaration section. If you use one kind of section more than once in a declaration section, be sure to declare types, variables, and constants before you use them in subsequent sections.

For More Information:

- On user-defined procedures and functions (Chapter 6)
- On program structure (Chapter 7)
- On modules (Section 7.4)

3.1. CONST Section

The CONST section defines symbolic constants by associating identifiers with compile-time expressions; it has the following form:

```
CONST
    {constant-identifier = constant-expression}; ...

constant-identifier
```

The identifier of the symbolic constant being defined.

constant-expression

Any legal compile-time expression.

Once a constant identifier is associated with an expression, the identifier retains the value of that expression throughout the scope in which it was declared. You can change the value only by changing the definition in the CONST section.

Consider the following example:

```
TYPE
  array_type1 = ARRAY[1..10] OF INTEGER;
CONST
  Year      = 1984;
  Tiny     = 1.7253;
  Month    = 'November';
  Initial  = 'P';
  Lie     = FALSE;
  Untruth  = Lie;
  Almost_Pi = 22.0/7.0;
  array_const =
    array_type1[1..3,5 : 1; 4,6 : 2; 7..9 : 3; 10 : 7];
```

For More Information:

- On expressions (Section 4.1)
- On constructors (Section 2.4)

3.2. LABEL Section

A **label** is a tag that makes an executable statement accessible to a GOTO statement. The LABEL section declares labels and has the following form:

```
LABEL
  {label},...;
```

label

A decimal integer between 0 and 9999 (as an extension, between 0 and MAXINT), or a symbolic name. When declaring several labels, you can specify them in any order. The declaration and the occurrence of the label must be at the same level in the program.

A label can appear only once within the scope of the label declaration. It can precede any executable statement in the program. Use a colon (:) to separate the label from the statement it precedes. Labels can be accessed only by GOTO statements.

Consider the following example:

```
LABEL
  marker, 5;
{In the executable section: }
IF a <= 150 THEN GOTO 5
ELSE GOTO marker ;
.
.
.
5: a := a + 1;
.
```

```
.  
.marker: WHILE x < 20 DO {Statement...}
```

For More Information:

- For information on the GOTO statement, see Section 5.8.

3.3. TO BEGIN DO Section

The TO BEGIN DO section allows you to specify a statement, in a module that is to be executed before the executable section of the main program; it has the following form:

```
TO BEGIN DO statement;  
  
statement
```

A Pascal statement.

The TO BEGIN DO section can only appear in modules, can only appear once in a module, and must appear as the last section in the declaration section. (If appearing together, the TO BEGIN DO section must precede the TO END DO section at the end of the declaration section.)

Consider the following example:

```
MODULE x( INPUT, OUTPUT );  
VAR  
    Debug : BOOLEAN;  
PROCEDURE Test(...); {Executable section...}  
  
TO BEGIN DO  
    BEGIN  
        WRITE('Debug Module x?  ');  
        READLN( Debug );  
    END;  
END.
```

As a general rule, if a program or module inherits an environment file, the compiler executes the initialization section in the inherited module before the initialization section in the program or module that inherited it. If a module or program inherits more than one module that contains an initialization section, the order of execution of the inherited modules is undefined.

Consider the following example:

```
[ENVIRONMENT( 'Mod1' )] MODULE Mod1;  
VAR  
    i : INTEGER;  
TO BEGIN DO  
    i := 5;  
  
{In a separate compilation unit:}  
[INHERIT( 'Mod1' )] MODULE Mod2;  
VAR  
    j : INTEGER;  
TO BEGIN DO
```

```
j := i + 1; {First execute code in Mod1 for correct results}
```

Figure 3.1 shows the order of execution of initialization and finalization sections. Each circle is a module that contains both a TO BEGIN DO and a TO END DO section, and each arrow indicates the order of inheritance for the environment files.

Figure 3.1. Order of Execution for TO BEGIN DO and TO END DO Sections

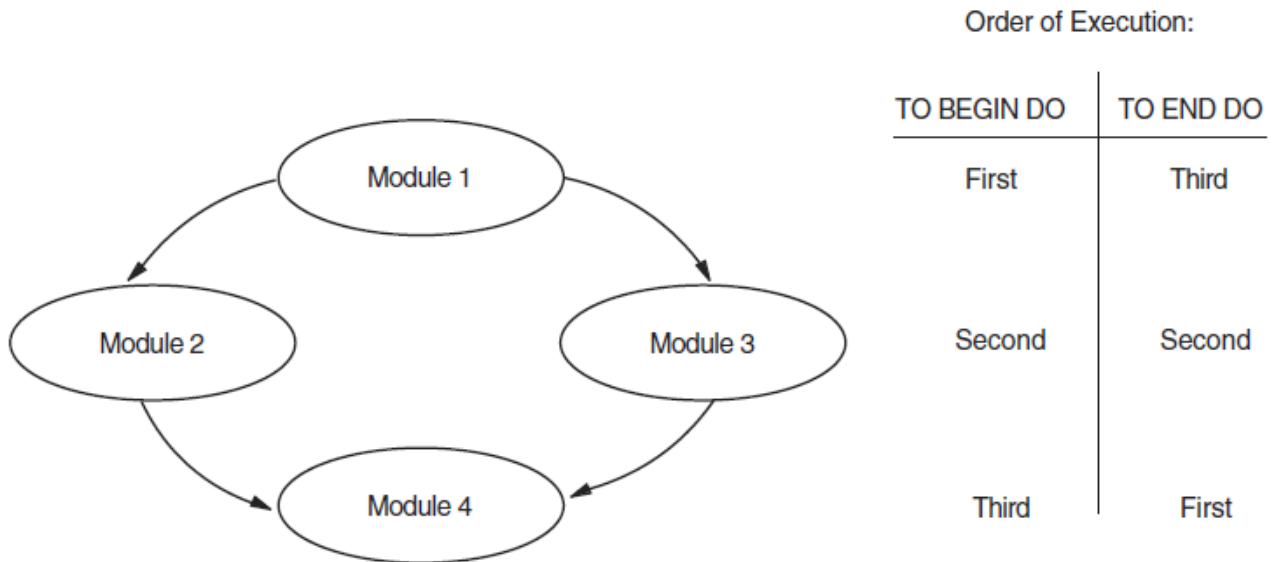

ZK-1321A-AI

The execution order for initialization and finalization sections in Modules 2 and 3 cannot be determined. The headers for the modules in Figure 3.1 are as follows:

```
[ENVIRONMENT] MODULE Mod1; ...
[ENVIRONMENT, INHERIT( 'Mod1' )] MODULE Mod2; ...
[ENVIRONMENT, INHERIT( ' Mod1' )] MODULE Mod3; ...
[INHERIT( 'Mod2', 'Mod3' )] MODULE Mod4; ...
```

The name of the compiler-generated initialization routine is formed by taking the module name and appending %INIT. If you wish to provide a different name, you can use the [GLOBAL] attribute on the top of the module to specify a different name. For example:

```
[ENVIRONMENT, GLOBAL(MYINIT)] MODULE Mod1; ...
```

This alternate name is encoded in the resulting environment file so all modules that inherit this environment will automatically call the initialization routine by its new alternate name.

For More Information:

- On modules (Section 7.4)
- On environment files (Section 7.5.1)

3.4. TO END DO Section

The TO END DO section allows you to specify a statement in a module that is to be executed after the executable section of the main program; it has the following form:

```
TO END DO statement;  
  
statement
```

A Pascal statement.

The TO END DO section can only appear in modules, can only appear once in a module, and must appear as the last section in the declaration section. (If appearing together, the TO END DO section must come after the TO BEGIN DO section at the end of the declaration section.)

As a general rule, if a compilation unit inherits an environment file, the finalization section in the inheriting compilation unit must be executed before the finalization section in the inherited compilation unit. Also, if more than one module with a finalization section inherits a single module, the order of finalization of the inheriting modules cannot be determined. Figure 3.1 shows an example of the order of execution of TO END DO sections.

The compiler implements a TO END DO section by creating an invisible TO BEGIN DO section if TO BEGIN DO wasn't used or by augmenting an existing TO BEGIN DO section with a call to the Pascal Run-Time Library to register the finalization routine.

Here is an example using both TO BEGIN DO and TO END DO:

```
MODULE File_Output;  
VAR  
    Out_File : TEXT;  
    t        : TIMESTAMP;  
PROCEDURE Test(...); {Executable section...}  
  
TO BEGIN DO  
  
    OPEN( Out_File, 'foo.dat' );  
  
TO END DO  
BEGIN  
    GETTIMESTAMP( t );  
    WRITELN( 'foo.dat closed at', TIME( t ) );  
  
    CLOSE( Out_File )  
  
END;  
END.
```

For More Information:

- On modules (Section 7.4)
- On environment files (Section 7.5.1)

3.5. TYPE Section

The TYPE section introduces the name and set of values for a user-defined type or schema declaration.

It has the following form:

```

[[type-attribute-list]]
TYPE
    {type-identifier = [[attribute-list]] type-denoter }
    { {schema-declaration }
      {
        [[VALUE initial-state-specifier]]};...

```

type-attribute-list

One or more attributes that apply to the entire TYPE section. Only the ALIGN, ENUMERATION_SIZE, or HIDDEN attributes can be specified here.

type-identifier

The identifier of the type being defined.

attribute-list

One or more identifiers that provide additional information about the type-denoter.

type-denoter

Any legal Pascal type syntax.

schema-declaration

The declaration of a schema type.

initial-state-specifier

A compile-time expression that is assignment compatible with a variable of the TYPE identifier being defined. VSI Pascal initializes all variables declared to be of this type with the constant value or values provided (unless there is an overriding initial-state-specifier in the variable declaration).

The following rules apply to the use of initial-state-specifiers on data types:

- You must initialize a type with a compile-time expression of an assignment-compatible type. Scalar types require scalar constants; structured types require constant constructors.
- You cannot initialize file types or types containing file components.
- The predeclared function ZERO can be used to initialize an entire type (except file types and TIMESTAMP types) to binary zero.
- The constant identifier NIL or a call to the ZERO function are the only values with which you can initialize a pointer type.

This example declares variables of user-defined types. Note that in the declaration of variable week5, the VALUE Sun overrides the initial state specified in the TYPE declaration by VALUE Mon.

```

TYPE
    Days_of_Week = ( Sun, Mon, Tues, Wed, Thurs, Fri, Sat )
                  VALUE Mon;
    Array_Template( Upper_Bound : INTEGER ) =
                  ARRAY [1..Upper_Bound] OF INTEGER;
VAR
    {Declaring variables of user-defined types:}
    week1, week2, week3, week4 : Days_of_Week; {Initial value: Mon}
    week5 : Days_of_Week VALUE Sun;           {Initial value: Sun}

```

```
array_type2 : array_template( x ); {x is a run-time expression}
```

VSI Pascal requires that all user-defined type identifiers (except base types of pointers) be defined before they are used in the definitions of other types. A base type must be defined before the end of the TYPE section in which it is first mentioned, as shown in the this example:

```
TYPE
  Ptr_to_Movie = ^Movie;           {Movie is defined later}
  Name  = PACKED ARRAY[1..20] OF CHAR; {Defined before used}
  Movie = RECORD
    Title, Director : Name;
    Year  : INTEGER;
    Stars : FILE OF Name;
    Next  : Ptr_to_Movie;
  END;
```

For More Information

- On data types (Chapter 2)
- On schema types (Section 2.5)
- On pointers (Section 2.3)
- On attributes (Chapter 10)

3.6. VALUE Section

If you choose, you can use the VALUE section as an VSI Pascal extension that initializes ordinal, real, array, record, set, and string variables. (If you require portable code, use the VALUE reserved word in either TYPE definitions or VAR declarations.) The exact format of an initialization depends on the type of the variable being initialized. The VALUE section has the following form:

```
VALUE
  {variable-identifier := constant-expression};...

variable-identifier
```

The name of the variable to be initialized. You cannot specify a list of variable identifiers. You can initialize a variable or variable component only once in the VALUE section. Any variables appearing in the VALUE section must appear in a previous VAR section.

```
constant-expression
```

Any constant expression that is assignment compatible with the variable identifier.

Unlike other declaration sections, the VALUE section can appear only in a program or module declaration section. You cannot use the VALUE declaration section in procedures or functions. If you wish to initialize variables in procedures and functions, use an initial-state specifier (by using the VALUE reserved word in either the TYPE or VAR section).

You can assign values to complete structured variables or to a single component of that variable.

For More Information:

- On data types (Chapter 2)

- On expressions (Section 4.1)

3.7. VAR Section

The VAR section declares variables and associates each variable with an identifier, a type, and an optional initial value.

It has the following form:

```
[[var-attribute-list]]
VAR
  {{variable-identifier}},... : [[attribute-list]] type-denoter
  {:=      }
  [[ {VALUE } initial-state-specifier ] ] };...
```

var-attribute-list

One or more attributes that apply to the entire VAR section. Only the ALIGN, ENUMERATION_SIZE or HIDDEN attributes can be specified here.

variable-identifier

The identifier of the variable being declared.

attribute-list

One or more identifiers that provide additional information about the variable.

type-denoter

Any legal Pascal type syntax.

initial-state-specifier

Any constant expression that is assignment compatible with the variable identifier. The variable is initialized to this expression.

You can combine several identifiers in the same variable declaration if the variables are of the same type and are being initialized either with the same value or not at all.

Consider the following example:

```
TYPE
  Hours_Worked = ARRAY[1..10] OF INTEGER;
VAR
  Answer, Rumor : BOOLEAN;
  Temp          : INTEGER VALUE 60;
  Grade         : 'A'..'D';
  Weekly_Hours : Hours_Worked VALUE [1..3 : 7; OTHERWISE 5];
```

The following rules apply to the use of initial-state specifiers on variables:

- You must initialize a variable with a constant expression of an assignment-compatible type. Scalar variables require scalar constants; structured variables require constant constructors.

- You cannot initialize file variables or variables containing file components.
- You can use the predeclared function `ZERO` to initialize all or part of a variable (except file variables and components) to binary zero.
- The constant identifier `NIL` or a call to the `ZERO` function are the only values with which you can initialize a pointer variable.

A reference to a variable consists of the variable's use in one of the following situations:

- The variable or one of its components is passed as a `VAR`, `%REF`, or `%DESCR` parameter. The reference lasts throughout the call to the corresponding routine.
- The variable or one of its components is used on the left side of an assignment statement. The reference lasts throughout the execution of the statement.
- The variable or one of its components is accessed by a `WITH` statement. The reference lasts throughout the execution of the statement.

The existence of a variable reference sometimes prohibits certain operations from being performed on the variable. Such restrictions are noted throughout this manual.

For More Information:

- On constructors (Section 2.4)
- On data types (Chapter 2)
- On attributes (Chapter 10)
- On the `ZERO` function (Section 8.109)
- On pointers and `NIL` (Section 2.3)
- On the assignment and `WITH` statements (Chapter 5)

Chapter 4. Expressions and Operators

This chapter discusses the following topics:

- Section 4.1: Expressions
- Section 4.2: Operators
- Section 4.3: Structured Function-Return Values
- Section 4.4: Type Conversions

4.1. Expressions

Pascal expressions consist of one or more operands that result in a single value. If the expression contains more than one operand, the operands are separated by operators. Operands include numbers, strings, constants, variables, and function designators. Operators include arithmetic, relational, logical, string, set, and typecast operators.

Pascal recognizes two forms of expressions: **constant expressions** and **run-time expressions**. Constant expressions result in a value at the time you compile your program. These expressions can contain constants, constant identifiers, operators, and some predeclared functions. Constant expressions cannot contain the following:

- Variable references
- Schema discriminants
- Bound identifiers from conformant parameters
- Calls to user-defined functions
- Calls to EOF and EOLN predeclared functions
- Constructors of schema types or of types containing schema components

Run-time expressions result in a value at the time you execute your program. These expressions can contain variables, predeclared functions, user-declared functions, and everything that a constant expression cannot contain.

When you form an expression, the operands must be of the same data type. Under some circumstances, the compiler performs data type conversions and allows you to form an expression with operands of different types.

Pascal does not evaluate expressions contained within a single statement in a predictable order. Also, the compiler does not always evaluate all expressions in a single statement if the correct execution of the statement can be determined by evaluation of fewer expressions. For example, some IF statement conditions can be determined TRUE or FALSE by only evaluating one of the Boolean expressions in the condition. Do not write code that depends on the evaluation order of expressions, and, in some cases, on the evaluation of all expressions in a single statement. If you require a predictable order of evaluation, you can use the AND_THEN and OR_ELSE operators.

For More Information:

- On data type conversion (Section 4.4)

- On data types (Chapter 2)
- On evaluation of IF statement conditions (Section 5.9)
- On the AND_THEN and OR_ELSE logical operators (Section 4.2.3)

4.2. Operators

Pascal provides several classes of operators. You can form complex expressions by using operators to combine constants, constant identifiers, variables, and function designators.

Pascal also provides the assignment operator (`:=`) for use in assignment statements.

For More Information:

- On precedence of operators (Section 4.2.7)
- On assignment statements (Section 5.1)

4.2.1. Arithmetic Operators

An arithmetic operator provides a formula for calculating a value.

Table 4.1 lists the arithmetic operators that you can use, in combination with numeric operands, to perform an arithmetic operation.

Table 4.1. Arithmetic Operators

Operator	Example	Result
+	A+B	Sum of A and B
-	A-B	B subtracted from A
*	A*B	Product of A and B
**	A**B	A raised to the power of B
/	A/B	A divided by B
DIV	A DIV B	Result of A divided by B truncated toward zero
REM	A REM B	Remainder of A divided by B
MOD	A MOD B	MOD function of A with respect to B

The +, -, *, ** Operators

You can use addition, subtraction, multiplication, and exponentiation operators on integer, unsigned, real, DOUBLE, and QUADRUPLE operands. These operators produce a result of the same type as the values. In exponentiation operations, if the data types of the operands are not the same, the operand of the less precise type is converted and the result is of the more precise type.

When you use a negative integer as an exponent, the exponentiation operation can yield unexpected results. Table 4.2 shows the defined results of integers raised to the power of negative integers.

Table 4.2. Results of Negative Exponents

Base	Exponent	Result
0	Negative or 0	Error

Base	Exponent	Result
1	Negative	1
-1	Negative and odd	-1
-1	Negative and even	1
Any other integer	Negative	0

For example, the expression $1^{(-3)}$ equals 1; $(-1)^{(-3)}$ equals -1; $(-1)^{(-4)}$ equals 1; and $3^{(-3)}$ equals 0.

The / Operator

You can use the division operator (/) on integer, unsigned, real, DOUBLE, and QUADRUPLE operands. The division operator always produces a real result. This result can reflect in some loss of precision as the compiler converts integer and unsigned operands to their real equivalents. With one or more operands of higher precision, the result is of the higher-precision type.

DIV, REM, MOD Operators

You can use the DIV, REM, and MOD operators only on integer and unsigned operands. DIV divides one integer or unsigned operand by the other, producing an integer or unsigned result. DIV truncates toward zero any remaining fraction and does not round the result. For example, the expression $23 \text{ DIV } 12$ equals 1, and $(-5) \text{ DIV } 3$ equals -1.

REM returns the remainder after dividing the first operand by the second. Thus, $5 \text{ REM } 3$ evaluates to 2. Similarly, $3 \text{ REM } 3$ evaluates to 0 and $(-4) \text{ REM } 3$ evaluates to -1.

MOD returns the remainder of $A \text{ MODULO } B$. The result of the operation $A \text{ MOD } B$ is defined only when B is a positive integer. This result is always an integer between 0 and $B-1$. The modulus of A with respect to B is computed as follows:

- If A is greater than B , then B is subtracted repeatedly from A until the result is a nonnegative integer less than B .
- If A is less than B and not negative, the result is A .
- If A is less than zero, B is added repeatedly to A until the result is a nonnegative integer less than B .

For example, $5 \text{ MOD } 3$ equals 2, $(-4) \text{ MOD } 3$ equals 2, and $2 \text{ MOD } 5$ equals 2.

When both operands are positive, the REM and MOD operators return the same result. For example, $28 \text{ REM } 5$ equals 3 and $28 \text{ MOD } 5$ equals 3. However, when the first operand is negative, REM produces a negative or zero result, while MOD produces a positive or zero result. For example, $(-42) \text{ REM } 8$ equals -2 and $(-42) \text{ MOD } 8$ equals 6.

Enabling subrange checking ensures that a MOD operation is legal by verifying at run time that B is a positive integer.

Note that the use of negative integer and real number constants as operands in MOD and exponentiation operations can not produce the results you expect because the minus sign (-) is actually a negation operator. For example, the expression $-2.0 * *2$ is equivalent to the expression $-(2.0 * *2)$ and produces the result -4.0. Therefore, you should enclose a negative constant in parentheses to make sure that it is interpreted as you intend. The expression $(-2.0) * *2$ produces the result 4.0.

Table 4.3 lists the result types of arithmetic operations with operands of various types.

Table 4.3. Result Types of Arithmetic Operators

Operator	Type of Operands	Result Type
+ - * **	INTEGER, INTEGER64, UNSIGNED, UNSIGNED64 REAL, DOUBLE, QUADRUPLE	Same as the operands if both are of the same type; otherwise, the operand of the lower-ranked type is converted and the result is of the higher-ranked type.
/	INTEGER, INTEGER64, UNSIGNED, UNSIGNED64, REAL, DOUBLE, QUADRUPLE	One of the real types—REAL if the operands are of type REAL (or SINGLE) or a lower-ranked type; otherwise, the operand of the lower-ranked type is converted and the result is of the higher-ranked type.
DIV REM MOD	INTEGER, INTEGER64, UNSIGNED, UNSIGNED64	Same as the operands if both are of the same type; otherwise, the operand of the lower-ranked type is converted and the result is of the higher-ranked type.

For More Information:

- On integers (Section 2.1.1.1)
- On real numbers (Section 2.2)
- On more precise and less precise operands, and on type conversions (Section 4.4)
- On using the CHECK attribute and SUBRANGE option for MOD run-time checking (Section 10.2.8)

4.2.2. Relational Operators

A relational operator tests the relationship between two ordinal, real, DOUBLE, or QUADRUPLE expressions and returns a Boolean result. If the relationship holds, the result is TRUE; otherwise, the result is FALSE. Table 4.4 lists the relational operators that you can apply to arithmetic operands. You can also apply some of the relational operators to string operands and to set operands.

Table 4.4. Relational Operators

Operator	Example	Result
=	A = B	TRUE if A is equal to B
<>	A <> B	TRUE if A is not equal to B
<	A < B	TRUE if A is less than B
<=	A <= B	TRUE if A is less than or equal to B
>	A > B	TRUE if A is greater than B
>=	A >= B	TRUE if A is greater than or equal to B

Note that operators designated with two characters must appear in the order specified and cannot be separated by a space.

For More Information:

- On relational operators in string expressions (Section 4.2.4)

- On relational operators in set expressions (Section 4.2.5)
- On the BOOLEAN data type (Section 2.1.3)

4.2.3. Logical Operators

A logical operator evaluates one or more Boolean expressions and returns a Boolean value. The logical operators are listed in Table 4.5.

Table 4.5. Logical Operators

Operator	Example	Result
AND	A AND B	TRUE if both A and B are TRUE
OR	A OR B	TRUE if either A or B is TRUE, or if both are TRUE
NOT	NOT A	TRUE if A is FALSE, and FALSE if A is TRUE
AND_THEN	A AND_THEN B	TRUE if both A and B are TRUE; forces left-to-right evaluation order with short circuiting
OR_ELSE	A OR_ELSE B	TRUE if either A or B is TRUE, or if both are TRUE; forces left-to-right evaluation order with short circuiting

The AND, AND_THEN, OR, and OR_ELSE operators combine two conditions to form a compound condition. The NOT operator reverses the value of a single condition so that if A is TRUE, NOT A is FALSE, and vice versa.

The following examples show logical expressions and their Boolean results:

```

{ Expressions:                               Results: }
( 4 > 3 ) AND ( 18 = 3 * 6 )                 {TRUE}
( 3 > 4 ) OR ( 18 = 3 * 6 )                  {TRUE}
NOT ( 4 <> 5 )                                {FALSE}
( i < 11 ) AND_THEN ( Array_A[i] = 0 )      {Not known}
p = NIL OR_ELSE p^ = 0                       {Not known}

```

You can use Boolean variables and functions as operands in logical expressions. Consider the following example:

```
Flag AND ODD( i )
```

Suppose that Flag is a Boolean variable and ODD(i) is a function that returns TRUE if the value of the integer variable i is odd and FALSE if the value of i is even. Both operands, Flag and ODD(i), must be TRUE for the expression to be TRUE.

Normally, the compiler does not guarantee the evaluation order for logical operations. The AND_THEN and OR_ELSE operators force the compiler to evaluate an expression from left to right, stopping when the overall result can be determined (also called **short circuiting**). The following example forces the compiler to verify that an array element is within index bounds before evaluating the element's contents:

```
IF ( i < 11 ) AND_THEN ( Array_A[i] = 0 ) THEN
    WRITELN( 'Index bounds are legal and element contained 0' );
```

The precedence of `AND_THEN` and `OR_ELSE` is the same as `AND` and `OR`, respectively. Because the Pascal language associates parameters of operands at the same precedence level from left to right, you might not get the answer you expect. For example, in this code you might expect the `AND_THEN` to guard all the expressions to its right:

```
IF ( PTR <> NIL ) AND_THEN ( P^.DATA1 = 0 ) AND ( P^.DATA2 = 1 ) THEN ...
```

However, `AND_THEN` is at the same precedence level as `AND`, so the previous expression is equivalent to:

```
IF ( ( PTR <> NIL ) AND_THEN ( P^.DATA1 = 0 ) ) AND ( P^.DATA2 = 1 ) THEN ...
```

Given this association and the fact that the two operands of the `AND` operator can be evaluated in any order, the compiler might evaluate `P^.DATA2 = 1` without it being guarded by the `PTR <> NIL` test.

To guard both dereferences to `P`, you must use parentheses as shown in this example:

```
IF ( PTR <> NIL ) AND_THEN ( ( P^.DATA1 = 0 ) AND ( P^.DATA2 = 1 ) ) THEN ...
```

Alternatively, you can replace all the occurrences of `AND` and `OR` with `AND_THEN` and `OR_ELSE`, respectively. For example,

```
IF ( PTR <> NIL ) AND_THEN ( P^.DATA1 = 0 ) AND_THEN ( P^.DATA2 = 1 ) THEN ...
```

For More Information:

- On precedence of operators (Section 4.2.7)
- On the `BOOLEAN` data type (Section 2.1.3)

4.2.4. String Operators

A string operator concatenates or compares character-string expressions. The result of the operation is either a string or a Boolean value. Table 4.6 lists the string operators.

Table 4.6. String Operators

Operator	Example	Result
+	A+B	String that is the concatenation of strings A and B
=	A=B	TRUE if strings A and B have equal ASCII values
<>	A <>B	TRUE if strings A and B have unequal ASCII values
	A B	TRUE if ASCII value of string A is less than that of string B
=	A =B	TRUE if ASCII value of string A is less than or equal to that of string B
>	A>B	TRUE if ASCII value of string A is greater than that of string B
>=	A>=B	TRUE if ASCII value of string A is greater than or equal to that of string B

With the plus sign (+), you can concatenate any combination of `STRING` and `VARYING` character strings, packed arrays of characters, and single characters.

The result of a string comparison depends on the ordinal value in the ASCII character set of the corresponding characters in the strings. For example:

```
'motherhood' > 'cherry pie'
```

This relational expression is TRUE because lowercase 'm' comes after lowercase 'c' in the ASCII character set. If the first characters in the strings are the same, Pascal searches for differing characters, as in the following example:

```
'string1' < 'string2'
```

This expression is TRUE because the digit 1 precedes the digit 2 in the ASCII character set.

The relational operators are legal for testing character strings of different lengths as well as for testing character strings of the same lengths. The shorter of the two character strings is padded with blanks for the comparison. The following two strings, for instance, result in a value of TRUE:

```
'John' < 'Johnny'  
'abc' = 'abc  '
```

The EQ, NE, GE, GT, LE, and LT predeclared routines make string comparisons that are similar to the relational operators, but these routines do not pad strings of unequal length with blanks. Instead, they halt string comparison when they detect unequal lengths.

If you are comparing the equality or inequality of very large strings, it is sometimes more efficient to use the EQ and NE functions instead of the = and <> operators. When using the operators, VSI Pascal compares each string, character by character, until detecting either a difference or the end of one string. When you use the functions, VSI Pascal sometimes detects different string lengths without comparing the strings character by character.

When trying to determine the length of a string, you can use either the LENGTH function, or the .LENGTH component of a STRING (or VARYING OF CHAR) type. The LENGTH routine and .LENGTH provide the same value. Consider the following example:

```
VAR  
    One_String : STRING( 25 ) VALUE 'Harvey Fierstein';  
{In the executable section:}  
WRITELN( One_String.LENGTH, LENGTH( One_String ) );
```

The WRITELN call writes 16 and 16 to the predeclared file OUTPUT (by default, to your terminal).

Enabling bounds checking causes the length of all character strings to be checked at run time for illegal operations.

For More Information:

- On the BOOLEAN data types (Section 2.1.3)
- On string data types (Section 2.6)
- On the CHECK attribute and the BOUNDS option for run-time character-string checking (Section 10.2.8)
- On the EQ, NE, GE, GT, LE, and LT routines (Chapter 8)

4.2.5. Set Operators

A set operator forms the union, intersection, difference, or exclusive-OR of two sets, compares two sets, or tests an ordinal value for inclusion in a set. Its result is either a set or a Boolean value. Table 4.7 lists the set operators.

Table 4.7. Set Operators

Operator	Example	Result
+	A+B	Set that is the union of sets A and B
*	A*B	Set that is the intersection of sets A and B
-	A-B	Set of those elements of set A that are not also in set B
=	A=B	TRUE if set A is equal to set B
<>	A <>B	TRUE if set A is not equal to set B
<=	A <=B	TRUE if set A is a subset of set B
>=	A >=B	TRUE if set B is a subset of set A
IN	C IN B	TRUE if C is an element of set B
NOT IN	C NOT IN B	TRUE if C is not an element of B

Most set operators require both operands to be set expressions. The IN and NOT IN operators, however, require an ordinal expression as the first operand and a set expression as the second operand. The ordinal expression must be of the same type as the set's base type. For example:

```
2*3 IN [1..10]
```

```
5*3 NOT IN [1..10]
```

The result of this IN operation is TRUE because $2 * 3$ evaluates to 6, which is a member of the set [1..10], and the NOT IN operation also returns TRUE because $5 * 3$ evaluates to 15, which is not a member of the set [1..10].

The XOR predeclared routine can return the set of elements that do not appear in both sets.

For More Information:

- On the SET data type (Section 2.4.3)
- On the BOOLEAN data type (Section 2.1.3)
- On the XOR function (Section 8.108)

4.2.6. Type Cast Operator

Normally, VSI Pascal associates each variable with one type: the type with which the variable was declared. In some systems' programming applications, you can perform operations more efficiently by relaxing VSI Pascal's strict type-checking rules. VSI Pascal provides the type cast operator for this purpose.

The type cast operator changes the context in which you can use a variable or an expression of a certain data type. The actual representation of the object being cast is not altered by the type cast operator. VSI Pascal overrides the type only for the duration of one operation. It has one of the following forms:

```

{variable-identifier }
{(expression) } :: type-identifier

```

The type cast operator (::) separates the name of a variable or an expression in parentheses from its target type, the type to which it is being cast. The operator alters the type of the cast object at that point only.

Once you cast a variable or an expression, the object has all the properties of its target type during the execution of the operation in which the type cast operator appears. A variable and its target type must have the same allocation size. Therefore, you cannot cast a conformant-array parameter, but you can cast a fixed-size component of a conformant-array parameter. A schema variable or parameter cannot be type cast since it does not have a size that is known at compile time.

When you cast an expression in parentheses, the value of that expression can be either truncated on the left or padded on the left with zeros, so that the allocation size of the expression's value and its target type become the same. The type of a cast expression cannot be VARYING OF CHAR, a conformant-array parameter, or a discriminated schema. In addition, the target type of a cast expression cannot be VARYING OF CHAR or a discriminated schema.

Consider the following example:

```

TYPE
  F_float = PACKED RECORD
    Frac1 : 0..127;
    Expo  : 0..255;
    Sign  : BOOLEAN;
    Frac2 : 0..65535;
  END;

VAR
  A : REAL;
{In the executable section:}
A::F_float.Expo := A::F_float.Expo + 1;

```

In this example, the record type F_float shows the layout of an F_floating real number. The real variable A is cast as a record of this type, allowing you to access the fields containing the mantissa, exponent, sign, and fraction of A. Adding 1 to the field containing the exponent gives the same result as multiplying A by 2.0.

For More Information:

- On data types (Chapter 2)
- On the VOLATILE attribute (Section 10.2.42)
- On conformant-array parameters (Section 6.3.7.1)

4.2.7. Precedence of Operators

The operators in an expression establish the order in which VSI Pascal combines the operands. The compiler performs operations with higher-precedence operators before operations with lower-precedence operators. Table 4.8 lists the order of operator precedence, from highest to lowest (operators on the same line are of equal precedence).

Table 4.8. Precedence of Operators

Operators	Precedence
::	Highest

Operators	Precedence
NOT	
**	
*, /, DIV, REM, MOD, AND, AND_THEN	
+, -, OR, OR_ELSE, unary +, unary -	
=, <>, <, <=, >, >=, IN	Lowest

In Pascal, operators of equal precedence (such as plus and minus) are combined from left to right within the expression.

You must use parentheses for correct evaluation of an expression that combines relational operators. Consider the following expression:

```
a<=x AND b<=y
```

Without parentheses, this expression is interpreted as $A \leq (X \text{ AND } B) \leq Y$. The logical operator AND requires its operands X and B to be Boolean expressions and returns a Boolean result, which is then used as an operand in evaluating one of the relational operators (\leq). This operation causes an error because you cannot use relational operators with Boolean operands. You can modify the expression with parentheses as follows:

```
( a<=x ) AND ( b<=y )
```

In the rewritten expression, the compiler combines the Boolean values of the two relational expressions with the AND operator.

You can use parentheses in an expression to force a particular order for combining the operands. For example:

Expression	Result
8 * 5 DIV 2-4	16
8 * 5 DIV (2-4)	-20
8 * 5 DIV 2-4	16
8 * 5 DIV (2-4)	-20

The compiler evaluates the first expression according to normal precedence rules.

First, 8 is multiplied by 5 and the result (40) is divided by 2. Then 4 is subtracted to get 16. The parentheses in the second expression, however, force the subtraction of 4 from 2 (yielding -2) to be performed before the division of 40 by -2. The result is -20.

Parentheses can help to clarify an expression. For instance, you could write the first example as follows:

```
( ( 8 * 5 ) DIV 2 ) -4
```

The parentheses eliminate any confusion about how the compiler associates the operands in the expression.

The desired results of your program should not depend on the order of subexpression evaluation. Unless you use the AND_THEN or OR_ELSE operators, the compiler does not guarantee the order in which subexpressions and complex expressions are evaluated. In fact, if the result of an expression can be determined without complete evaluation, VSI Pascal can partially evaluate some logical operations.

Usually the order of evaluation does not prevent the correct result from being produced. However, order of evaluation is very important when you write logical operations involving function designators that have side effects. (A side effect is an assignment to a nonlocal variable or to a variable parameter within a function block.)

For example, the following IF statement contains two function designators for function `f`:

```
IF f( a ) AND f( b ) THEN {Statement...}
```

The compiler can evaluate these two function designators in any order. Regardless of which function designator the compiler evaluates first, if the result is `FALSE` the other function designator does not have to be evaluated.

Suppose that function `f` assigns the value of its parameter to a nonlocal variable. Because you cannot know which function designator was evaluated first, you cannot be sure of the value of the nonlocal variable after the IF statement is performed.

For More Information:

- On expressions (Section 4.1)
- On the `AND_THEN` or `OR_ELSE` logical operators (Section 4.2.3)
- On user-defined functions (Chapter 6)
- On optimization, compiler switches, and order of evaluation (*VSI Pascal for OpenVMS User Manual*)

4.3. Structured Function-Return Values

Syntactically, a function call is an expression since it returns a value. If a function returns a pointer, an array, or a record, you can directly dereference, index, or select the returned value. For example:

```
WRITELN( Make_Node( 10 )^.Data[1] );  
WRITELN( Make_Vector( 15 )[2] );  
Make_Node( 10 )^.Data[1] := 42;
```

4.4. Type Conversions

Because VSI Pascal is a strongly typed language, you cannot normally treat a value of one type as though it were of a different type, as you can in many languages. For example, you cannot assign the character `'1'` to a variable of type `INTEGER`, because `'1'` is not an integer constant but a character constant. However, there are times when it makes sense to combine values of two different types because the values have some aspect in common. For example, suppose you wish to add a value of type `REAL` to a value of type `INTEGER`. This operation is legal because the value of type `INTEGER` is converted to its equivalent value of type `REAL` before the operation is performed. The result of the operation is of type `REAL`.

In VSI Pascal, values are converted from one type to another when the conversion is required for an operation, an assignment, or a formal/actual parameter association. Before any type conversion, the arithmetic types are ranked as follows, from lowest to highest:

- `INTEGER`
- `UNSIGNED`

- INTEGER64
- UNSIGNED64
- REAL or SINGLE
- DOUBLE
- QUADRUPLE

Similarly, the character types are also ranked as follows, from lowest to highest:

- CHAR
- PACKED ARRAY OF CHAR
- STRING or VARYING OF CHAR strings

When values of two different arithmetic or character types are combined in an expression, the lower-ranked operand is converted to its equivalent in the higher-ranked type. The result of an operation in which conversion occurs is always of the higher-ranked type.

All conversions or assignments to values of type UNSIGNED or UNSIGNED64 are never checked for overflow. When combined with other unsigned values, negative integer values are converted to large unsigned values by the calculation of the modulus with respect to 2^{**32} or 2^{**64} . the modulus with respect to 2^{**32} or 2^{**64} .

Conversions or assignments to values of type INTEGER or INTEGER64 can overflow. Overflow will be detected at run time if overflow checking is enabled. Overflow will occur if the value is outside the range -MAXINT to MAXINT for converting to INTEGER, or outside the range -MAXINT64 to MAXINT64 for converting to INTEGER64.

A special case of conversion can occur when you attempt to assign an expression of type VARYING OF CHAR or STRING strings to a variable of type PACKED ARRAY OF CHAR or if you try to pass a string expression to a formal value parameter of type PACKED ARRAY OF CHAR. If the varying-length string has less than or exactly the same number of components as the packed array, the varying-length string is converted to a packed array of characters before the assignment is made and padded with blanks as necessary. If you attempt to perform this assignment with a varying-length string that has more components than the packed array, a run-time error occurs.

For More Information:

- On data types (Chapter 2)

Chapter 5. Statements

VSI Pascal statements specify actions to be performed and appear in executable sections. This chapter discusses the following statements:

- Assignment statement (Section 5.1)
- BREAK statement (Section 5.2)
- CASE statement (Section 5.3)
- Compound statement (Section 5.4)
- CONTINUE statement (Section 5.5)
- Empty statement (Section 5.6)
- FOR statement (Section 5.7)
- GOTO statement (Section 5.8)
- IF statement (Section 5.9)
- Procedure call (Section 5.10)
- REPEAT statement (Section 5.11)
- RETURN statement (Section 5.12)
- WHILE statement (Section 5.13)
- WITH statement (Section 5.14)

When coding, separate statements with a semicolon (;). The semicolon is not syntactically part of a statement, so it is not included in the syntax examples in this chapter.

5.1. Assignment Statement

The assignment statement uses an assignment operator (:=) to assign a value to a variable or to a function identifier. An assignment statement has the following form:

```
variable-access := expression
```

`variable-access`

An identifier, array component, record component, pointer dereference, pointer-function dereference, or file buffer.

`expression`

A run-time expression whose type is assignment compatible with the type of the variable. The value of the expression is the value assigned to the variable.

You cannot assign values to a variable of a record type with variants if you allocated this variable using the NEW procedure. You can assign values to a field of such a record variable.

Consider the following example:

```
VAR
  x      : INTEGER;
  y, z   : RECORD
    f1 : real;
    f2 : integer
  END;
{In the executable section:}
x := 1; {type of expression is same type as the variable}
y := z; {variables are assignment compatible}
Func_Return_Ptr_To_Integer( 3 )^ := 19;
```

For More Information:

- On the NEW procedure (Section 8.58)
- On assigning constructor values to structured variables (Section 2.4)
- On assignment compatibility (Section 2.10.2)

5.2. BREAK Statement

The BREAK statement immediately transfers control to the first statement past the end of the FOR, WHILE, or REPEAT statement that contains the BREAK statement. The BREAK statement appears as a single word:

```
BREAK
```

BREAK is equivalent to a GOTO to a label placed just past the end of the closest FOR, WHILE, or REPEAT statement. The following example shows the usage of the BREAK statement:

```
REPEAT
  name := GetInput('Your name?');
  IF ExitKeyPressed THEN BREAK;
  address := GetInput('Your address?');
  IF ExitKeyPressed THEN BREAK;
  Person[Num].Name := name;
  Person[Num].Addr := address;
  Num := SUCC(Num);
UNTIL Num > 50;
```

In the example, a user-defined function GetInput interacts with the user and sets a global Boolean variable ExitKeyPressed if the user presses an Exit key. The BREAK statement exits the loop here, without storing data in the array.

Use caution when using the BREAK statement because future additions to the code can result in the BREAK statement leaving a different loop than was originally intended.

5.3. CASE Statement

The CASE statement causes one of several statements to be executed. Execution depends on the value of an ordinal expression called the **case selector**. A CASE statement has the following form:

```

CASE case-selector OF
  [[{{case-label-list}};...: statement};...]
  [[ [[:]] OTHERWISE {statement};... ]]
  [[:]]
END

```

case-selector

An expression of an ordinal type.

case-label-list

One or more case labels of the same ordinal type as the case selector, separated by commas. A case label can be a single constant expression, such as 1, or a range of expressions, such as 5..10.

statement

Any statement to be executed depending on the values of both the case-selector and the case-label.

You can specify case labels in any order within the case-label-list. Each case label can appear only once within a given CASE statement.

At run time, the system evaluates the case selector expression and chooses which statement to execute. If the value of the case selector does not appear in the case-label-list, the system executes the statement in the OTHERWISE clause. If you omit the OTHERWISE clause, the value of the case selector must be equal to one of the case labels. If the value is not equal to a label, the CASE statement result is undefined.

Consider the following example:

```

CASE Age OF
  1..4   : School := 'preschool';   {Subranges}
  5..8   : School := 'elementary';
  9..13  : School := 'middle';
  14..18 : BEGIN
            School := 'high';
            WRITELN( 'Difficult years!' );
            END;                    {Compound statements}
  19     : School := 'reform';      {Single ordinal value}
  OTHERWISE School := 'graduated'; {If 1 > Age > 18 ...}
END;

```

For More Information:

- On ordinal values (Section 2.1)
- On using the CHECK attribute to check selectors at run time (Section 10.2.8)

5.4. Compound Statement

A compound statement groups a series of statements so that they can appear anywhere that language syntax calls for a single statement. A compound statement has the following form:

```

BEGIN
  {statement};...
END

```

statement

Any Pascal statement, including other compound statements.

The statements that make up the compound statement must be separated with semicolons (;), although the semicolon before the END delimiter is optional.

Consider the following example:

```
IF a < 10 THEN
  BEGIN           {A compound statement}
    x := 10;
    y := 20;
    z := x + y;
  END           {No semicolon in THEN clause before an ELSE}
ELSE z := 29;   {A single statement}
```

For More Information:

- On program executable sections (Section 7.4)
- On function and procedure executable sections (Section 6.1)

5.5. CONTINUE Statement

The body of a FOR, WHILE, or REPEAT loop can include the CONTINUE statement. The CONTINUE statement is equivalent to a GOTO to a label placed at the end of the statements in the body of the FOR, WHILE, or REPEAT statement. The CONTINUE statement appears as a single word:

```
CONTINUE
```

In a loop that processes a series of data items, you can use the CONTINUE statement to indicate that the rest of the loop does not apply to the current item, and that the program should continue to the next statement.

Use caution when using the CONTINUE statement because future additions to the code can result in the CONTINUE statement continuing with a different loop than was originally intended.

5.6. Empty Statement

The empty statement causes no other action to occur than the advancement of program flow to the next statement. To use the empty statement, place a semicolon where the language syntax calls for a statement.

Consider the following example:

```
CASE Alphabetic OF
  'A', 'E', 'I', 'O', 'U' : Alpha_Flag := Vowel;
                          'Y' : ; {Empty statement as selector; no action}
  OTHERWISE Alpha_Flag := Consonant;
END;
```

5.7. FOR Statement

The FOR statement is a looping statement that repeats execution of a statement according to the value of a control variable. The control variable assumes a value within a specified range or set. A FOR statement has one of the following forms:

```
FOR control-variable := initial-value {TO          }
                                {DOWNTO       } final-value DO statement

FOR control-variable IN set-expression DO statement

control-variable
```

The name of a previously declared variable of an ordinal type.

initial-value

Expressions that form a range and whose type is assignment compatible with the type of the control variable.

set-expression

An expression resulting in a value of SET type. The base type of the set must be assignment compatible with the control variable.

statement

Any Pascal statement that does not change the value of the control variable.

At run time, the initial- and final-values or the set-expression is evaluated before the loop body is executed. Execution or termination of the statement occurs in the following cases:

- In the TO form, Pascal checks to see if the value of the control variable is less than or equal to the final-value. If this condition is met, the control-variable takes on the value of the initial-value for the first loop iteration. During iterations, the control variable increments according to its data type. Looping ceases when the control-variable is greater than the final-value.
- In the DOWNTO form, Pascal checks to see if the value of the control-variable is greater than or equal to the final-value. If this condition is met, the control variable takes on the value of the initial-value for the first loop iteration. During iterations, the control-variable decrements according to its data type. Looping ceases when the control-variable is less than the final-value.
- In the set-expression form, Pascal checks to see if the set-expression is not the empty set. If this condition is met, the control-variable takes on the value of one of the members of the set. Iterations occur for each member of the set; the selection order of members of the set is undefined. Looping stops after the loop body executes for each member of the set.

In both the TO and the DOWNTO forms, how the control-variable increments or decrements depends on its type. For example, values expressed in type INTEGER increment or decrement in units of 1. Values expressed in type CHAR increment or decrement in accordance with the ASCII collating sequence.

After normal termination of the FOR statement, the control-variable does not retain a value. You must assign a new value to this variable before you use it elsewhere in the program. If the FOR loop terminates with a GOTO statement, the control-variable retains the last assigned value. In this case, you can use the variable again without assigning a new value.

Consider the following examples:

```
FOR Year := 1899 DOWNTO 1801 DO {Print leap years in 1800's}
  IF ( Year MOD 4 ) = 0 THEN
    WRITELN( Year:4, ' is a leap year' );

FOR I IN Set1 DO {Set2 members are successors of Set1 members}
  Set2 := Set2 + [I + 1];
```

For More Information:

- On ordinal values (Section 2.1)
- On sets (Section 2.4.3)

5.8. GOTO Statement

The GOTO statement causes an unconditional branch to a statement prefixed by a label. A GOTO statement has the following form:

```
GOTO label
```

```
label
```

An unsigned decimal integer or symbolic name that represents a statement label.

The GOTO statement must be within the scope of the label declaration. A GOTO statement that is outside a structured statement cannot jump to a label within that structured statement. A GOTO statement within a routine can branch to a labeled statement in an enclosing block only if the labeled statement appears in the block's outermost level. Consider the following example:

```
FOR I := 1 TO 10 DO
  BEGIN
    IF Real_Array[I] = 0.0 THEN
      BEGIN
        Result := 0.0;
        GOTO 10;          {Use GOTO to exit from loop}
      END;
    Result := Result + 1.0/Real_Array[I]; {Compute sum of inverses}
  END;

10: Invertsum := Result;
```

For More Information:

- On label declarations (Section 3.2)
- On exiting FOR loops using GOTO (Section 5.7)

5.9. IF Statement

The IF statement tests a Boolean expression and performs a specified action if the result of the test is TRUE. The ELSE clause, when it appears, executes only if the test condition results to FALSE. An IF statement has the following form:

```
IF boolean-expression THEN statement1 [[ELSE statement2]]
```

boolean-expression

Any Boolean expression.

statement1

The statement to be executed if the value of the Boolean expression is TRUE.

statement2

The statement to be executed if the value of the Boolean expression is FALSE.

If an IF statement contains an ELSE clause, the statement in the THEN clause cannot be followed with a semicolon (;), since that completes the IF statement and separates it from the following statement. The following examples contain correct code:

```
IF x > 10 THEN y := 4           IF x > 10 THEN BEGIN y := 4;
                               ELSE y := 5;                               z := 5;
                                                                           END
                                                                           ELSE y := 5;
```

The ELSE clause always modifies the closest IF-THEN statement. Use caution to avoid logic errors in nested IF statements, as in the following:

```
IF A = 1 THEN      {First IF}
  IF B <> 1 THEN   {Second IF}
    C := 1
ELSE              {Appears to modify first IF}
  C := 0;         {Actually modifies second IF}
```

VSI Pascal can not always evaluate all the terms of a Boolean expression if it can evaluate the entire expression based on the value of one term. Either do not write code that depends on actual evaluation (or evaluation order) of Boolean expressions, or use the AND_THEN and OR_ELSE operators for a predictable order of evaluation.

For More Information:

- On Boolean expressions (Section 2.1.3)
- On forming and evaluating expressions (Section 4.1)
- On the AND_THEN and OR_ELSE logical operators (Section 4.2.3)

5.10. Procedure Call

Syntactically, a procedure call is a statement. A procedure call has the following form:

```
routine-identifier [[({actual-parameter},...)]]
```

routine-identifier

The name of a procedure or function.

actual-parameter

An expression that is of a type that is compatible with the type of the formal parameter, or the name of a procedure or function.

In VSI Pascal, you can use procedure-call syntax to call a function, even though function calls are usually considered to be expressions. If you do this, the compiler invokes the function but ignores the return value.

For More Information:

On procedures and functions (Chapter 6)

5.11. REPEAT Statement

The REPEAT statement is a looping statement and executes one or more statements until a specified condition is true. A REPEAT statement has the following form:

```
REPEAT
    {statement};...
UNTIL expression
```

statement

Any Pascal statement.

expression

Any Boolean expression.

Pascal always executes a REPEAT statement for one iteration; iterations continue as long as the Boolean expression is FALSE. When specifying more than one statement as the loop body to a REPEAT statement, do not enclose the statements with the BEGIN and END reserved words. Multiple statements are legal in the REPEAT loop body.

Consider the following example:

```
REPEAT
  READ( x );      {Attempts to read at least one character}
  IF ( x IN ['0'..'9'] ) THEN
    BEGIN        {Keep count of numbers and increase total}
      Digit_Count := Digit_Count + 1;
      Digit_Sum := Digit_Sum + ORD( x ) - ORD( '0' );
    END
  ELSE
    Char_Count := Char_Count+1;  {Count characters}
UNTIL EOLN(INPUT); {Reads from default device until end of line}
```

For More Information:

- On Boolean expressions (Section 2.1.3)

5.12. RETURN Statement

The RETURN statement passes control back to the caller of a PROCEDURE, FUNCTION, PROGRAM, or module initialization or finalization section. A RETURN statement is equivalent to a GOTO to a label placed just before the END of the body, and in a PROGRAM, has the effect of stopping the program. A RETURN statement has the following form:

```
RETURN [ return-value ]
```

```
return-value
```

Inside a **FUNCTION**, `return-value` specifies an ending value for the **FUNCTION**. If no `return-value` is provided, the last value assigned to the function identifier is used as the function result. The `return-value` type and function type must be the same.

Inside a **PROGRAM**, the `return-value` specifies an ending value for the **PROGRAM**. If you do not provide a `return-value`, VSI Pascal uses the value 1.

A function returns a result to its caller. A function can specify its result by assigning a value to the function identifier. This does not cause a return to the caller, and can occur many times per call. When the function finally returns, the last assignment becomes the result of the function. If a function uses the **RETURN** statement and includes a value, then the function returns immediately and returns the specified value. This value overrides any previous values specified by an assignment.

If a function uses the **RETURN** statement but does not specify a value, the return value is the last value that the function specified by assignment. If the function has not assigned a value to the function identifier during a given call to the function, VSI Pascal does not define the function result.

The following example shows the usage of **RETURN**. Here, a function searches through the array called `Data` for an element that matches `Suitable`. When it finds one, it assigns values to two global variables and executes a **RETURN**. Omitting the **RETURN** statement would make the function continue processing; it would assign values for the last suitable element instead of the first.

```
FUNCTION FindFirst(StartingPoint: INTEGER) : INTEGER;
    VAR i: INTEGER;
    BEGIN
    FOR i := StartingPoint TO MaximumNumber DO
    BEGIN
    IF Data[i] = Suitable THEN
    BEGIN
    AttributesOfDesiredData = Attributes[i];
    Subscript := i;
    RETURN i;
    END;
    END;
    END;
```

For More Information:

- On the **GOTO** statement (Section 5.8)

5.13. WHILE Statement

The **WHILE** statement is a loop that executes a statement while a specified condition is true. A **WHILE** statement has the following form:

```
    WHILE expression DO
        statement
```

```
expression
```

Any Boolean expression.

statement

Any Pascal statement.

Pascal checks the value of the Boolean expression before executing the loop body for the first time; if the expression is FALSE, the loop body is not executed. If the initial value is TRUE, loop iterations continue until the condition is FALSE. When specifying more than one statement as the loop body to a WHILE statement, enclose the statements with the BEGIN and END reserved words, since the syntax calls for a single statement to follow the DO reserved word. If you do not use a compound statement for the loop body, Pascal executes the first statement following the DO reserved word as the loop body.

Consider the following examples:

```
WHILE NOT EOF( File1 ) DO {If EOF from the start, the loop}
  READLN( File1 );      { body is not executed. }
```

```
WHILE NOT EOLN( INPUT ) DO
  BEGIN {Use compound statement:}
  READ( x );
  IF NOT ( x IN ['A'..'Z', 'a'..'z', '0'..'9'] )
  THEN
    Err := Err + 1; {Count odd characters as errors}
  END;
```

For More Information:

- On Boolean expressions (Section 2.1.3)
- On compound statements (Section 5.4)

5.14. WITH Statement

The WITH statement provides an abbreviated notation for references to the fields of a record variable or to the formal discriminants of a discriminated schema type. A WITH statement has the following form:

```
      {record-variable }
WITH {{schema-variable }},... DO statement
```

record-variable

The name of the record variable being referenced.

schema-variable

The name of the variable being referenced whose type is a discriminated schema type. This underlying type of the schema can be a record.

statement

Any Pascal statement.

The WITH statement allows you to refer to the fields of a record or to a formal discriminant of a schema by their names alone, rather than by the record.field-identifier or schema-variable.formal-discriminant syntax. In effect, the WITH statement opens the scope so that references to field identifiers or to formal discriminants alone are unambiguous. When you access a variable or one of its components using a WITH statement, the reference syntax lasts throughout the execution of the statement.

Specifying more than one variable has the same effect as nesting WITH statements. Consider the following example:

```
{The record Dog is nested in the record Cat:}
WITH Cat, Dog DO    {Specify Cat before Dog}
    Bills := Bills + Cat_Vet + Dog_Vet;

WITH Cat DO    {This is equivalent to the previous WITH}
    WITH Dog DO
        Bills := Bills + Cat_Vet + Dog_Vet;
```

If you are specifying nested records, their variable names must appear in the order in which they were nested in the record type definition. If you are working with record and schema variables that are not nested, you can specify variable names in any order. If you specify record or schema variables whose field names or formal discriminants conflict with one another, Pascal uses the last record or schema in the comma list. Consider the following example.

```
VAR
    x : STRING( 10 );
    y : STRING( 15 );

{In the executable section:}
WITH x, y DO
    WRITELN( CAPACITY );           {y.CAPACITY is used}

{The following is equivalent:}
WITH x DO
    WITH y DO
        WRITELN( CAPACITY );
```

For More Information:

- On records (Section 2.4.2)
- On schema types (Section 2.5)

Chapter 6. Procedures and Functions

This chapter discusses the following information about user-defined routines:

- Section 6.1: Routine Declarations
- Section 6.2: Routine Calls
- Section 6.3: Parameters

Procedures and functions are subprograms. A **procedure** contains one or more statements to be executed once the procedure is called. A **function** contains one or more statements to be executed once the function is called; in addition, functions return a single value. This manual refers to functions and procedures collectively as **routines**.

In addition to user-defined routines, VSI Pascal also allows you to access external routines (routines that are globally available on your system and that may or may not be written in VSI Pascal) and routines that are predeclared by the compiler.

For More Information:

- On predeclared routines (Chapter 8)
- On calling external routines (*VSI Pascal for OpenVMS User Manual*)

6.1. Routine Declarations

You must declare a routine before you call it. Routine declarations have the following formats:

```
[[attribute-list]] PROCEDURE routine-identifier [[(formal-parameter-list)]];
```

```
    [[{declaration-section}] BEGIN {statement};... END    }
    {{ EXTERN      }                                     }
    {{ EXTERNAL    }                                     }
    {{              }                                     } ;
    {{ FORTRAN     }                                     }
    {{ FORWARD     }                                     }
```

```
[[attribute-list]] FUNCTION routine-identifier [[(formal-parameter-list)]]
```

```
: [[attribute-list]] result-type-id;
    [[{declaration-section}] BEGIN {statement};... END    }
    {{ EXTERN      }                                     }
    {{ EXTERNAL    }                                     }
    {{              }                                     } ;
    {{ FORTRAN     }                                     }
    {{ FORWARD     }                                     }
    {                                                       }
```

attribute-list

One or more identifiers that provide additional information about the type-denoter.

routine-identifier

The name of the routine. If you use the routine-identifier within the routine body (with the exception of assigning a value to the routine-identifier of a function), the result is a recursive call to the routine. The

routine-identifier of a procedure can be redeclared in the procedure's declaration-section. The routine-identifier of a function cannot be redeclared in the function's declaration-section; however, it can be redeclared in any nested routines within the function's declaration-section.

`formal-parameter-list`

A comma list of the routine's formal parameters. A procedure can have as many as 255 formal parameters. A function can also have as many as 255 formal parameters unless returning a structured type, in which case a function is limited to 254 formal parameters. Optionally, you can specify a mechanism specifier and an attribute list for each parameter.

`declaration-section`

A routine declaration section can include all sections except TO BEGIN DO, TO END DO, and VALUE sections. Data specified in this declaration section is local to the routine and to any nested routines; you can redeclare identifiers that are declared in an outer block. You cannot redeclare a formal parameter identifier to be a local variable in the routine.

By default, the system does not retain the values of local variables after it exits from a routine. Each call to a routine creates copies of the local variables. This means you can call a routine recursively without affecting the values held by the local variables at each activation of the routine. To preserve the value of a local variable (not the copy) from one call to the next, you must declare the local variable with the `STATIC` attribute.

`statement`

Any Pascal statement. In a function executable section, there must be either a `RETURN` statement containing a value, or at least one statement of the following form:

`routine-identifier := result`

The routine-identifier is the name of the function. The result is a value of either an ordinal, real, structured, or pointer type that VSI Pascal returns when the function is called. (This value cannot be a file type or a structured type with a file component.) This value must be of the same type as the result-type-id.

`EXTERN`

Predeclared identifiers that direct VSI Pascal to find the body of the routine elsewhere. The `EXTERN`, `EXTERNAL`, and `FORTTRAN` identifiers declare routines that are independently compiled by VSI Pascal or that are written in other languages. In VSI Pascal, these identifiers are equivalent. Although not part of the Pascal standard, many Pascal compilers only accept the `FORTTRAN` identifier for external routines actually written in `FORTTRAN`; if portability is a concern, you may wish to use `FORTTRAN` only for external `FORTTRAN` routines.

The `FORWARD` identifier declares a routine whose block is specified in a subsequent part of the same procedure and function section, allowing you to call a routine before you specify its routine body. As an extension, VSI Pascal will allow the body to be in a different declaration part. If the body and heading are specified in different procedure and function sections, a `FORWARD` declared function should not be used as an actual discriminant to a schema type.

When you specify the body of the routine in subsequent code, include only the `FUNCTION` or `PROCEDURE` predeclared identifier, the routine-identifier, and the body of the routine. Do not repeat the formal-parameter, the attribute-list, or the result-type-id.

`result-type-id`

The type specification of the function return value. The function's result must be of this data type. This type cannot be a file type or a structured type with a file component.

Consider the following example:

```
{Function body contained in subsequent code;}
FUNCTION Adder( Op1, Op2, Op3 : REAL ) : REAL; FORWARD;

PROCEDURE Introduction;
VAR
    a, b, c, z : REAL;    {Variables local to the procedure}
BEGIN
    WRITELN( 'This is the Inventory Program Version 5.6.' );
    WRITELN;
    WRITELN( 'Press Ctrl/H for help.  Press Return to continue.' );
    a := 4.6;    b := 12.1;    c := 201.45;
    z := Adder( a, b, c );    {Call the function Adder}
END;

{System_Routine_Tanh available with the operating system;}
FUNCTION System_Routine_Tanh( Angle : REAL ) : REAL;

EXTERNAL;

FUNCTION Adder; {Do not repeat attributes or parameters}
BEGIN
    Adder := Op1 + Op2 + Op3;    {Assign a function return value}
END;
```

For More Information:

- On attributes (Chapter 10)
- On declaration sections (Chapter 3)
- On the scope of identifiers (Section 7.2)
- On parameters and passing mechanisms (Section 6.3)
- On recursive function calls (*VSI Pascal for OpenVMS User Manual*)
- On calling external routines (*VSI Pascal for OpenVMS User Manual*)

6.2. Routine Calls

A routine call executes all statements in the body of the declared routine. You must declare a routine before you can call it. Syntactically, procedure calls are statements, and function calls, which return a single value, are expressions. You can call a function anywhere that an expression of the declared result type is legal. If the result of a function is irrelevant, you can call the function as a statement in the same way that you call a procedure. You can call routines in the executable section of a program or in the body of another routine. Routine calls have the following forms:

```

                                [%IMMED   ]
                                [%REF     ]
procedure-identifier [[({ [%DESCR   ] actual-parameter}, ... )]]
```

```

                                [          ]
                                [%STDESCR ]

                                [%IMMED   ]
                                [%REF      ]
function-identifier [[({ [%DESCR   ] actual-parameter},...)]
                                [          ]
                                [%STDESCR ]

```

procedure-identifier

The declared routine identifier. The scope of a routine identifier is the block in which it is declared, excluding any nested blocks that redeclare the same identifier.

actual-parameter

The actual parameter whose data type matches the type of the corresponding formal parameter. Optionally, you can specify a passing mechanism for each parameter. When a mechanism specifier appears in a call, it overrides the type, semantics, mechanism specified, and even the number of parameters in the formal parameter declaration. Thus, type checking is suspended for the parameter association to which the specifier applies.

Consider the following example, which includes a procedure that takes no parameters and a function used as an expression:

```

VAR
    a, b, c, z : REAL;

PROCEDURE Introduction;
BEGIN
    WRITELN( 'This is the Inventory Program Version 5.6.' );
    WRITELN;
    WRITELN( ' Press Ctrl/H for help.  Press Return to continue.' );
END;

FUNCTION Adder( Op1, Op2, Op3 : REAL ) : REAL;
BEGIN
    Adder := Op1 + Op2 + Op3;    {Assign a function return value}
END;

{In the executable section:}
Introduction;    {No parameters necessary in the call}
a := 3.14;      b := 14.78;      c := 112.456;
z := Adder( a, b, c );    {Function used as an expression
                           evaluating to a REAL value}

```

If a function returns a value of an array, record, or pointer type, you can index, select, or dereference the object at the time of the function call, without first assigning the function result to a variable, as shown in this example:

```

TYPE
    Player_Rec = RECORD
        Wins      : INTEGER;
        Losses    : INTEGER;
        Percentage : REAL;
    END;

VAR

```

```

Number : INTEGER;

FUNCTION Return_Player_Info( Player_Num : INTEGER ) : Player_Rec;
  {In the function body:}
  Return_Player_Info := Player_Rec[Wins: 3; Losses: 18;
                                Percentage: 21/3];

{In the executable section:}
WRITELN( Return_Player_Info( Number ).Losses, 'losses is poor!');

```

For More Information:

- On expressions (Section 4.1)
- On structured function-return values (Section 4.3)
- On parameters and passing mechanisms (Section 6.3)

6.3. Parameters

In VSI Pascal, there are two types of parameters: formal and actual parameters. A **formal parameter** (also called an argument) is located in the header of the routine declaration. You cannot redeclare a formal parameter in a routine's declaration section, but you can redeclare it in nested routines within the routine's declaration section.

The formal parameter establishes the **semantics**, the data type, and the required **passing mechanism** of the parameter. The general format of the formal parameter list is as follows.

```

      {value-parameter-spec      }
      {variable-parameter-spec   }
[[({ {routine-parameter-spec   } }; ... )]]
      {foreign-parameter-spec    }

```

The specific format of a formal parameter specification depends on the semantics (value, variable, routine, foreign) of the formal parameter you are declaring (conformant parameters also have a unique syntax).

Table 6.1 presents the VSI Pascal semantics for formal parameters.

Table 6.1. Formal Parameter Semantics

Parameter Type	Description
Value	Used only to provide input to the routine. After calling the routine, the value of the actual parameter remains unchanged.
Variable	Used to allow access to the actual parameter. If the routine makes changes to the value of the formal parameter, the value of the actual parameter changes accordingly.
Routine	Used to call another routine.
Foreign	Used to call a routine written in another language.

At run time, the formal parameter receives a value from the corresponding **actual parameter**, which is located in the routine call. The passing mechanism is the way in which the compiler passes the actual parameter value to the corresponding formal parameter. Table 6.2 presents the parameter-passing mechanisms supported by VSI Pascal.

Table 6.2. Parameter-Passing Mechanisms

Mechanism	Description
By immediate value	The information passed to the formal parameter is the data.
By reference	The information passed to the formal parameter is the address of the data.
By descriptor	The information passed to the formal parameter is the address of a descriptor of the data.

Note

Depending on the environment in which you are programming, not all passing mechanisms may be supported on your system.

The actual parameter must be of the same data type and passing mechanism as the corresponding formal parameter. VSI Pascal uses the default passing mechanism for each actual parameter depending on its data type and formal definition. If the called routine is external to VSI Pascal, you can specify an explicit passing mechanism on the actual parameter that overrides the type and number of formal parameters.

For More Information:

- On undiscriminated schema types (Section 2.5)
- On external routines (Section 6.3.5)

6.3.1. Value Parameters

By the rules of value semantics defined by the Pascal standard, a formal value parameter represents a local variable within the called routine. When you specify value semantics, the address of the actual parameter is passed to the called routine, which then copies the value from the specified address to its own local storage. The routine then uses this copy. The copy is not retained when control returns to the calling block. Therefore, if the called routine assigns a new value to the formal parameter, the change is not reflected in the value of the actual parameter.

When you do not include a reserved word before the name of a formal parameter, you automatically cause VSI Pascal to use value semantics to pass data to that parameter. A formal value parameter has the following form:

```

{identifier},... : [[attribute-list]] {type-identifier          }
                                     {undiscriminated-schema-name }
                                     {conformant-parameter-syntax  }
      [[:= [[mechanism-specifier]] default-value]]

```

identifier

The name of the formal parameter. Multiple identifiers must be separated with commas.

attribute-list

One or more identifiers that provide additional information about the formal parameter.

type-identifier

The type identifier of the parameters in this section.

undiscriminated-schema-name

The name of an undiscriminated schema type.

conformant-parameter-syntax

The type syntax of a conformant array or a conformant VARYING parameter.

mechanism-specifier

The mechanism by which a default value is to be associated with the formal parameter.

default-value

A compile-time expression representing the default value for the formal parameter.

Any attributes associated with a formal parameter become attributes of the local variable. They do not affect the values that can be passed to the parameter; they affect the behavior of the formal parameter only within the routine block. When a formal parameter has the UNSAFE attribute, the types of the actual parameters passed to it are not checked for compatibility.

An actual value parameter must be an expression whose type is assignment compatible with the type of the corresponding formal parameter. Because there is no assignment compatibility for file variables, undiscriminated schema sets, and undiscriminated schema subranges, they can never be passed as value parameters. Also, the names of routines are not allowed as value parameters.

If necessary, the type of an actual parameter is converted to the type of the formal parameter to which it is being passed. In this case, VSI Pascal follows the same type conversion rules that it uses to perform any other assignment. You may, for example, pass an integer expression to a formal parameter of a real type. If an actual parameter has the UNSAFE attribute, no conversion occurs.

If you have a user-defined, formal parameter of an undiscriminated schema type, the corresponding actual parameter must be discriminated from the same schema type as that of the formal parameter.

When you pass a string expression to a formal value parameter of type STRING, the actual parameter's current length (not its declared maximum length) becomes both the maximum length and the current length of the formal parameter.

You can also use the attributes [CLASS_S], [CLASS_A], and [CLASS_NCA] on value parameters if a routine requires a specific type of descriptor for VSI Pascal to build. A [CLASS_A], [CLASS_NCA] or [CLASS_S] formal value parameter requires the actual value parameters to be passed with the by descriptor mechanism.

The following examples show the use of value parameters:

```
VAR
  Old_Number, x, y : INTEGER;
FUNCTION Random( Seed : INTEGER ): INTEGER;
  {Function body...}
PROCEDURE Alpha( a, b : INTEGER; c : CHAR );
  {Procedure body...}

{In the executable section:}
New_Number := Random( Old_Number );
Alpha ( x+y, 11, 'G' ); {Actual parameters are integer
```

```
and character expressions}
```

For More Information:

- On blocks and scope (Section 7.2)
- On conformant parameters (Section 6.3.7)
- On default values for formal parameters (Section 6.3.9)
- On mechanism specifiers (Section 6.3.5)
- On the UNSAFE attribute (Section 10.2.40)
- On type conversions (Section 4.4)

6.3.2. Variable Parameters

By the rules of variable semantics defined by the Pascal standard, a formal variable parameter represents another name for a variable in the calling block. It is preceded by the reserved word VAR. When you specify variable semantics, the address of the actual parameter is passed to the called routine. In contrast to value semantics, the called routine directly accesses the actual parameter. Thus, the routine can assign a new value to the formal parameter during execution and the changed value is reflected immediately in the calling block (the value of the actual parameter changes).

VSI Pascal uses variable semantics to pass data to a formal parameter, often called a formal VAR parameter, and has the following form:

```
VAR {identifier},... : [[attribute-list]] {type-identifier           }
                               {undiscriminated-schema-name      }
                               {conformant-parameter-syntax      }
    [[:= [[mechanism-specifier]] default-value]]
```

identifier

The name of the formal parameter. Multiple identifiers must be separated with commas.

attribute-list

One or more identifiers that provide additional information about the formal parameter.

type-identifier

The type identifier of the parameters in this parameter section.

undiscriminated-schema-name

The name of an undiscriminated schema type.

conformant-parameter-syntax

The type syntax of a conformant array or a conformant VARYING parameter.

mechanism-specifier

The mechanism by which a default value is to be associated with the formal parameter. A mechanism specifier can be used only on a declaration for an external routine.

default-value

A compile-time expression representing the default value for the parameter. A default value can be used only on an external routine.

When you use variable semantics, the actual parameter must be a variable or a component of an unpacked structured variable (you can pass an entire packed structure); no expressions are allowed unless the formal parameter has the READONLY attribute. The type of a variable passed to a routine must be structurally compatible with the type of the corresponding formal parameter, except for schema parameters. For a formal parameter that is an undiscriminated schema type, the type of the variable must be discriminated from the same type as that of the formal parameter (they must be of the same schema type family). For a formal parameter that is a discriminated schema type, the type of the variable must be of the same type family and must have equivalent actual discriminants.

The names of routines are never allowed as variable parameters. In addition, you must use variable semantics when passing a file variable as an actual parameter. Also, you cannot pass the tag field of a variant record to a formal VAR parameter.

Consider the following example:

```
VAR My_String :  
  
VARYING [20] OF CHAR  
  
PROCEDURE Name( VAR A_String :  
  
VARYING [String_Size] OF CHAR  
  
{Body}  
  
{In the executable section:}  
Name( My_String );  
WRITELN( 'The new name is ', My_String );
```

This example declares a procedure, Name, which returns a new name through the formal parameter A_String. Procedure Name modifies the value of A_String; since My_String is passed by variable semantics, upon completion of the routine the modified value is reflected in the variable My_String.

In VSI Pascal, certain attributes in a routine declaration or a routine call affect the rules of compatibility between actual and formal VAR parameters. These rules also apply to the corresponding components of structured types and to the base types of pointer types used as formal parameters. The attributes that result in rule changes are the alignment, POS, READONLY, size, UNSAFE, VOLATILE, and WRITEONLY attributes.

You can also use the attributes [CLASS_S], [CLASS_A], and [CLASS_NCA] on variable parameters if a routine requires a specific type of descriptor for VSI Pascal to build. A [CLASS_A], [CLASS_NCA] or [CLASS_S] formal variable parameter requires the actual variable parameters to be passed with the by descriptor mechanism.

For More Information:

- On blocks and scope (Section 7.2)
- On conformant parameters (Section 6.3.7)
- On default values for formal parameters (Section 6.3.9)

- On mechanism specifiers (Section 6.3.5)
- On attributes and parameter compatibility (Chapter 10)
- On type conversions (Section 4.4)

6.3.3. Routine Parameters

To write a routine that invokes another routine whose effect is not determined until the program is executed, use routine parameters. To declare a procedure or a function as a formal parameter to another routine, you must include a complete routine heading in the formal parameter list. You can also associate a foreign mechanism specifier and a default value with a formal procedure or function parameter.

The following examples show formal routine parameter sections in procedure and function declarations:

```
PROCEDURE Apply( FUNCTION Operation( Left, Right : REAL ) : REAL;  
                VAR Result : REAL );
```

```
FUNCTION Copy( PROCEDURE Get_Char( VAR c : CHAR );  
              PROCEDURE Put_Char( i : CHAR ) ) : BOOLEAN;
```

The identifiers listed as formal parameters to a formal procedure or function parameter are not accessible outside the routine declaration; they indicate the number and kind of actual parameters necessary. You refer to these identifiers only when you use nonpositional syntax to call a routine parameter.

In the previous example, the formal parameter list of `Get_Char` informs the compiler that `Copy` must pass one character parameter to `Get_Char` using variable semantics. `Copy` does not refer explicitly to the formal parameter `c` unless it calls `Get_Char` using nonpositional syntax.

To pass a routine as an actual parameter, the formal parameter list of the routine being passed and the routine specified as the formal parameter must be congruent. Two formal parameter lists are congruent if they have the same number of sections and if the sections in corresponding positions meet any of the following conditions:

- Both are value parameter sections containing the same number of parameters. The types of parameters must either be compatible or be equivalent conformant parameters.
- Both are variable parameter sections containing the same number of parameters. The types of the parameters must either be compatible or be equivalent conformant parameters. Any attributes associated with a formal variable parameter affect the kinds of actual parameters that can be passed to it.
- Both are procedure parameter sections having either congruent formal parameter lists or no formal parameters.
- Both are function parameter sections having either congruent formal parameter lists or no formal parameters, and having compatible result types.
- Both are foreign parameter sections having the same mechanism specifier and the same number of parameters, and whose types must be compatible.
- If one formal parameter list has a `LIST` attribute on its last parameter section, the other formal parameter list must also have this attribute.

The following example shows a function declaration that includes two functions as formal parameters:

```

VAR
  Costs, Pay, Fedtax, Food : REAL;
  Housing                    : INTEGER;

FUNCTION Income( Salary, Tax : REAL ) : REAL;
  {Function body...}

FUNCTION Expenses( Rent : INTEGER; Grocery : REAL ) : REAL;
  {Function body...}

FUNCTION Budget( FUNCTION Credit( Earnings, UStax : REAL ) : REAL;
  FUNCTION Debit( Housing : INTEGER; Eat : REAL ) : REAL ) : REAL;
  VAR  Deduct : REAL;
  BEGIN {FUNCTION Budget}
    Deduct := Debit(

Eat := Food, Housing := Housing

    Budget := Credit( Pay, Fedtax ) - Deduct;
  END;

{In the executable section:}
Costs := Budget( Income, Expenses );

```

When the function Budget is called, the function Income is passed to the formal function parameter Credit, and the function Expenses is passed to the formal function parameter Debit. When Credit is called, the program-level variables Pay and Fedtax are substituted for Credit's formal parameters, Earnings and UStax. In the call to Debit, nonpositional syntax is used to associate Debit's formal parameters Housing and Eat with the program-level variables Housing and Food. The names of program-level variables do not conflict with formal parameters of routine parameters.

The presence of the ASYNCHRONOUS and UNBOUND attributes in routine declarations causes additional requirements to be imposed on the routines that can legally be passed as actual parameters.

For More Information:

- On routine headings (Section 6.1)
- On positional syntax (Section 6.3.8)
- On default values for formal parameters (Section 6.3.9)
- On mechanism specifiers (Section 6.3.5)
- On conformant parameters (Section 6.3.7)
- On attributes (Chapter 10)

6.3.4. Passing Predeclared Functions to Formal Function Parameters

The following predeclared functions can be passed directly to formal function parameters:

ABS	ARCTAN	CHR	CLOCK
COS	DBLE	EOF	EOLN

EXP	EXPO	INT	LN
ODD	ORD	QUAD	ROUND
SIN	SNGL	SQR	SQRT
STATUS	STATUSV	TRUNC	UAND
UFB	UINT	UNDEFINED	UNOT
UOR	UROUND	UTRUNC	UXOR

For example:

```
program math(output);

  procedure a( function f(r:real):real );
  begin
    writeln(f(1.0));
  end;

begin
  a(sin);
  a(cos);
end.
```

6.3.5. Foreign Parameters

When declaring an external routine (one written in a language other than Pascal) that is called by an VSI Pascal routine, you must specify not only the correct semantics but the correct mechanism as well. To allow you to obtain these passing mechanisms, VSI Pascal provides foreign mechanism specifiers and the passing mechanism attributes. Table 6.3 gives the method specifier or attribute used for each passing mechanism

Table 6.3. Specifiers and Attributes for Passing Mechanisms

Passing Mechanism	Specifiers and Attributes
By immediate value	%IMMED or [IMMEDIATE]
By reference	%REF or [REFERENCE]
By descriptor	%DESCR or %STDESCR

Note

Depending on the environment in which you are programming, not all passing-mechanism specifiers may be supported on your system.

The foreign mechanism specifier %IMMED, %REF, %DESCR or %STDESCR precedes a formal parameter in the declaration of an external routine. If the formal parameter does not represent a routine, the mechanism specifier must precede the parameter name. If the formal parameter represents a routine, the specifier must precede the reserved word PROCEDURE or FUNCTION in the parameter declaration.

In addition, it is possible to use the passing-mechanism attributes [IMMEDIATE] or [REFERENCE] in a formal parameter's attribute list to obtain the same behavior as %IMMED or %REF, respectively.

When calling an external routine, you must make sure that you pass actual parameters by the mechanism stated or implied in the routine declaration. VSI Pascal allows you to use the foreign mechanism specifiers `%IMMED`, `%REF`, `%DESCR`, and `%STDESCR` before an actual parameter in a routine call. (Passing-mechanism attributes are valid only on formal parameters.) When a mechanism specifier appears in a call, it overrides the type, semantics, mechanism specified, and even the number of parameters in the formal parameter declaration. Type checking is suspended for the parameter association to which the specifier applies.

The passing of an expression to a foreign mechanism parameter implies foreign value semantics: the calling block makes a copy of the actual parameter's value and passes this copy to the called routine. The copy is not retained when control returns to the calling block. Foreign value semantics differs from value semantics in that the calling block, not the called routine, makes the copy.

The passing of a variable to a foreign mechanism parameter (except a parameter with the `%IMMED` or `[IMMEDIATE]` specifier) implies foreign variable semantics: the variable itself is passed.

A compile-time warning occurs if the compiler must convert the value of an actual parameter variable to make it match the type of a foreign mechanism parameter. In that case, the compiler passes a copy of the converted value by foreign value semantics, using the specified mechanism. You can eliminate this warning by enclosing the actual parameter variable in parentheses; by doing so, you prevent the compiler from interpreting the actual parameter as a variable. The compiler takes the same action, whether or not it produces a warning message.

Mechanism specifiers on formal parameters produce the following results:

- A `%REF` or `[REFERENCE]` formal parameter requires actual parameters to be passed by reference. `%REF` or `[REFERENCE]` implies variable semantics unless the actual parameter is an expression; in that case, it implies foreign value semantics.
- An `%IMMED` or `[IMMEDIATE]` formal parameter requires actual parameters to be passed with the by immediate value mechanism and always implies value semantics. `%IMMED` or `[IMMEDIATE]` cannot be used on formal parameters of type `VARYING`, or on conformant array and conformant `VARYING` parameters.
- A `%DESCR` formal parameter requires actual parameters to be passed with the by descriptor mechanism and interprets the semantics as `%REF` or `[REFERENCE]` does.
- A `%STDESCR` formal parameter requires actual parameters to be passed with the by string descriptor mechanism. An actual parameter variable of type `PACKED ARRAY OF CHAR` implies variable semantics. An actual parameter expression of either type `PACKED ARRAY OF CHAR` or type `VARYING OF CHAR` implies foreign value semantics. You cannot use `%STDESCR` on formal procedure and function parameters.

Because the semantics are implicit in the mechanism, a formal parameter cannot be declared with both the reserved word `VAR` and a mechanism specifier.

Also, when passing an actual parameter to a formal foreign parameter, the VSI Pascal compiler checks for type compatibility when an external routine is called. However, at the time of the declaration, a formal parameter passed by immediate value that does not represent a routine is checked to ensure that it can be stored in 64 or fewer bits, or 32 or fewer bits, depending on the platform. A formal parameter passed by immediate value that does represent a routine must be declared with the `UNBOUND` attribute.

Special considerations arise when a function that has no formal parameters of its own (or that has defaults that are being used for all its formal parameters) is passed as a formal parameter to another routine. The appearance of the function identifier in an actual parameter list could indicate the passing

of either the address of the function or the function result. In VSI Pascal, the address of the function is passed by default, as shown in this example.

```
p( %IMMED f );      {Address of function f is passed}
```

To cause the function result to be passed, you must enclose the function identifier in parentheses, as shown in this example:

```
p( %IMMED (f) );   {Result of function f is passed}
```

For More Information:

- On conformant parameters (Section 6.3.7)
- On type conversions (Section 4.4)
- On attributes (Chapter 10)
- On calling external routines (*VSI Pascal for OpenVMS User Manual*)
- On compiler messages (*VSI Pascal for OpenVMS User Manual*)

6.3.6. Schema Parameters

VSI Pascal provides a method of processing schematic arrays, records, sets, subranges, and STRINGs with potentially different actual discriminants. To do this, you can use undiscriminated schema parameters.

An **undiscriminated schema formal parameter** is a type name that represents a specific schema family. The actual discriminants are determined each time you pass a corresponding actual parameter. The actual discriminants are available within the routine through the formal parameter.

You can use undiscriminated schema formal parameters when declaring value and variable parameters. When you use a formal, undiscriminated schema parameter instead of a conformant parameter or a type identifier, a call to the routine provides actual parameters that are discriminated from the same schema type family. However, when using value semantics, there are two exceptions:

- You cannot pass schema sets and schema subranges as value parameters, since there is no assignment compatibility for undiscriminated sets and for undiscriminated subranges.
- You can pass a varying-length string expression to a formal STRING parameter (the actual parameter does not have to be of the STRING type).

Consider the following example:

```
TYPE
  Array_Template( lbnd, hbnd : INTEGER ) =
    ARRAY[lbnd..hbnd] OF INTEGER;
VAR
  Even_Numbers : Array_Template( 1, 30 );
  Odd_Numbers  : Array_Template( 1, 60 );

PROCEDURE Print_Array( Array_To_Print : Array_Template );
  VAR
    i : INTEGER;
  BEGIN
    WRITELN( 'The maximum number of elements is ',
```

```

        Array_To_Print.hbnd );
WRITELN;
FOR I := LOWER( Array_To_Print ) TO UPPER( Array_To_Print ) DO
    WRITELN( Array_To_Print[i] );
END;

{In the executable section:}
Print_Array( Even_Numbers );
Print_Array( Odd_Numbers );

```

All passing-mechanism specifiers and attributes (%REF, %IMMED, %DESCR, %STDSCR, [REFERENCE], [IMMEDIATE], [CLASS_S], [CLASS_A], [CLASS_NCA]) are illegal on parameters of nonstatic types.

When you specify more than one formal schema parameter of the same schema type in a single parameter section, there are additional programming considerations.

If you specify more than one formal parameter (separated by commas) of a single, user-defined undiscriminated schema type, the corresponding actual parameters must be discriminated from the same type as the formal parameter (they must be of the same schema type family), and the actual schema parameters must have equivalent actual discriminant values. Consider the following example.

```

TYPE
    Array_Template( Upper_Bound : INTEGER )
                    = ARRAY[1..Upper_Bound] OF INTEGER;
VAR
    Actual_1, Actual_2 : Array_Template( 10 );
    Actual_3           : Array_Template( 20 );

    PROCEDURE Schema_Proc1( Only_One : Array_Template );
        {Body...}
    PROCEDURE Schema_Proc2( One, Two : Array_Template );
        {Body...}

{In the executable section:}
Schema_Proc1( Actual_1 );           {Legal}
Schema_Proc1( Actual_3 );           {Legal}
Schema_Proc2( Actual_1, Actual_2 ); {Legal}
Schema_Proc2( Actual_1, Actual_3 ); {Illegal}

```

When using value semantics, if you specify more than one formal parameter (separated by commas) of an undiscriminated STRING type, the corresponding actual parameters must have equivalent current lengths (not necessarily equivalent maximum lengths). Consider the following example.

```

VAR
    One_String, Two_String : STRING( 15 );
    Three_String           : STRING( 20 );

PROCEDURE Test_Strings( One, Two : STRING );
    {Body...}

{In the executable section:}
Test_Strings( 'a', 'b' );           {Legal}
Test_Strings( 'a', 'bb' );         {Illegal}
One_String := 'Hello';
Two_String := 'Hello there';
Three_String := 'olleH';
Test_Strings( One_String, Two_String ); {Illegal}

```

```
Test_Strings( One_String, Three_String ); {Legal}
```

When using variable semantics, if you specify more than one formal parameter (separated by commas) of an undiscriminated `STRING` type, the corresponding discriminated `STRING` actual parameters must have an equivalent maximum length.

For More Information:

- On user-defined schema types (Section 2.5)
- On the `STRING` predefined schema type (Section 2.6.3)

6.3.7. Conformant Parameters

VSI Pascal provides a method of processing arrays and character strings with potentially different maximum lengths. To do this, you can use conformant array parameters or conformant varying parameters.

A **conformant parameter** is a syntax that represents a set of types that are identical except for their bounds. The bounds of a conformant parameter are determined each time a corresponding actual parameter is passed. The bounds of an actual parameter are available within the routine through identifiers declared in the conformant parameter. A conformant parameter can appear only within a formal parameter list.

You can use conformant parameters when declaring value, variable, and foreign mechanism parameters. When you use a conformant parameter instead of a type identifier in a formal parameter declaration, a call to the routine can provide static and nonstatic arrays, `VARYING OF CHAR` strings, and discriminated strings (of the `STRING` schema family) of any size.

In addition, two conformant parameters are equivalent if they have indexes of the same ordinal type and components that either are compatible or are equivalent conformant parameters. They must also have the same number of dimensions and both must be packed or unpacked.

6.3.7.1. Conformant Array Parameters

The syntax for a conformant array has the following form:

```
ARRAY[{lower-bound-identifier..upper-bound-identifier :  
  [[attribute-list]] index-type-identifier};...] OF [[attribute-list]]  
  {type-identifier      }  
  {conformant-parameter-syntax  }
```

```
PACKED ARRAY[lower-bound-identifier..upper-bound-identifier :  
  [[attribute-list]] index-type-identifier] OF [[attribute-list]]  
type-identifier
```

`lower-bound-identifier`

An identifier that represents the lower bound of the conformant array's index.

`upper-bound-identifier`

An identifier that represents the upper bound of the conformant array's index.

`attribute-list`

One or more identifiers that provide additional information about the conformant array.

`index-type-identifier`

The type identifier of the index, which must denote an ordinal type.

`type-identifier`

The type identifier of the array components, which can denote any type.

To specify the range and type of the index, you must use type identifiers that represent predefined or user-defined ordinal types. The identifiers that represent the index bounds can be thought of as READONLY value parameters, implicitly declared in the procedure declaration.

Unless the conformant array is packed, the component can be either a type identifier or another conformant parameter; therefore, only the last dimension of a conformant parameter can be packed. The following example is illegal because the component of the packed array is another conformant parameter:

```
PACKED ARRAY[l1..u1: INTEGER; l2..u2: INTEGER] OF CHAR
```

However, the following is allowed because only the last component is packed:

```
ARRAY[l1..u1: INTEGER] OF PACKED ARRAY[l2..u2: INTEGER] OF CHAR
```

Consider the following example:

```
TYPE
  Workdays = 1..31;
  Feb_Days  = 1..28;
  Mar_Days  = 1..31;
VAR
  Feb_Arr      : ARRAY[Feb_Days] OF INTEGER;
  Mar_Arr      : ARRAY[Mar_Days] OF INTEGER;
  Feb_Total, Mar_Total : INTEGER;

FUNCTION Inventory( VAR Amt_Sold :
  ARRAY[First_Day..Last_Day : Workdays] OF INTEGER ) : INTEGER;
{In executable section:}
{Amt_Sold : ARRAY[1..28] OF INTEGER...}
Feb_Total := Inventory( Feb_Arr );

{Amt_Sold : ARRAY[1..31] OF INTEGER...}
Mar_Total := Inventory( Mar_Arr );
```

The formal parameter `Amt_Sold` can have index values from 1 to 31 to indicate the number of workdays in each month. Thus, an actual parameter passed to `Amt_Sold` could be an array whose index type is either `Feb_Days` or `Mar_Days`. Using a conformant parameter in this example allows you to write a general-purpose routine that sums the components of `Amt_Sold` and returns the monthly inventory total to the calling block.

For More Information:

- On ordinal types (Section 2.1)
- On arrays (Section 2.4.1)
- On attributes (Chapter 10)

6.3.7.2. Conformant VARYING Parameter

The syntax for a conformant VARYING string has the following form:

```
VARYING [upper-bound-identifier] OF [[attribute-list]] CHAR  
attribute-list
```

One or more identifiers that provide additional information about the conformant VARYING string.

```
upper-bound-identifier
```

An identifier that represents the upper bound of the conformant VARYING OF CHAR string's index. The type of the upper-bound-identifier is always an integer.

The upper-bound-identifier specifies the maximum length of the VARYING OF CHAR string and must denote an integer. The upper-bound-identifier that represents the maximum length can be thought of as a READONLY value parameter, implicitly declared in the procedure declaration.

When you pass a string expression to a value conformant varying-length parameter, the length of the actual parameter's current value parameter (not its declared maximum length) becomes both the current length and the maximum length of the formal parameter. When you pass either a conformant VARYING OF CHAR string variable or a discriminated STRING variable to a VAR conformant varying-length parameter, the declared maximum length of the actual parameter becomes the maximum length of the formal parameter.

The following example shows how to declare and use a VARYING OF CHAR conformant parameter:

```
VAR  
  Short_String : VARYING[40] OF CHAR := PAD( ' ', '-', 40 );  
  Long_String  : VARYING[80] OF CHAR := PAD( ' ', '-', 80 );  
  
PROCEDURE Dashed_Line( VAR String : VARYING[Len] OF CHAR ); {Body...}  
  
{In the executable section:}  
Dashed_Line( Short_String );  
Dashed_Line( Long_String );
```

In this example, note that Len is not a previously declared identifier but is instead an additional implicit parameter defined by the procedure declaration. The upper bound of the conformant parameter String is established by the declared maximum length of the actual parameter passed to it when the procedure Dashed_Line is called. The first call to Dashed_Line passes a 40-character string, so Len has the value 40. The second call passes an 80-character string, so Len has the value 80.

For More Information:

- On VARYING OF CHAR data types (Section 2.6.2)
- On attributes (Chapter 10)

6.3.7.3. Conformant Parameter Sections

When you specify more than one conformant parameter of the same type in a single parameter section, there are additional programming considerations.

When using value semantics, if you specify more than one formal parameter (separated by commas) of a single user-defined conformant parameter, the corresponding actual parameters must have either of the following characteristics:

- Equivalent current lengths (in the case of passing a string expression to a conformant PACKED array parameter of type CHAR or to a conformant VARYING OF CHAR)
- Indexes that are equivalent and of the same ordinal type, the same number of dimensions, and components that are compatible (in the case of passing a static or nonstatic array to a conformant array parameter)

Consider the following example:

```

VAR
  Actual_1, Actual_2 : ARRAY[1..10] OF INTEGER;
  Actual_3           : ARRAY[5..10] OF INTEGER;

PROCEDURE TestArr( One, Two : ARRAY [L1..U1 : INTEGER] OF INTEGER );
  {Procedure body...}
PROCEDURE TestStr( One, Two : PACKED [L2..U2 : INTEGER] OF CHAR );
  {Procedure body...}

{In the executable section:}
TestArr( Actual_1, Actual_2);      {Legal}
TestArr( Actual_2, Actual_3);      {Illegal}
TestStr( 'ABC', 'XYZ' );           {Legal}
TestStr( 'HELLO', 'GOODBYE' );     {Illegal}

```

When using variable semantics, if you specify more than one formal parameter (separated by commas) of a single, user-defined, conformant parameter, the corresponding actual variable parameters must be of the same type.

For More Information:

- On ordinal types (Section 2.1)
- On static and nonstatic types (Section 2.9)

6.3.8. Parameter Association

In most cases, a routine call must pass exactly one actual parameter for each formal parameter. The actual parameter is either listed explicitly in the routine call or supplied by means of a default value in the routine declaration.

One way of establishing the correspondence between actual and formal parameters is to give the parameters in each list the same position. That is, the association of actual and formal parameters proceeds from left to right, item by item, through both lists. This form of association is called **positional syntax**.

Another way of establishing correspondence is to specify the formal parameter name and the actual parameter being passed to it. In VSI Pascal, you can associate an actual parameter with a formal parameter using the assignment operator (:=). The actual parameters in the call do not have to appear in the same order as the formal parameters appeared in the declaration. This form of association is called **nonpositional syntax**.

You can use both positional and nonpositional actual parameters in the same call. However, after you specify one parameter in nonpositional syntax, all remaining parameters must be in nonpositional syntax (all parameters in positional syntax must be at the front of the list).

Consider the following example:

```

PROCEDURE Compute_Sum( x, y : INTEGER; VAR z : INTEGER ); {Body...}

{In the executable section:}
{Positional syntax:}
Compute_Sum( Quantity + 6, 15, Total );

{Nonpositional syntax:}
Compute_Sum(

z := Total, x := Quantity + 6, y := 15

{Both syntaxes:}
Compute_Sum( Quantity + 6,

z := Total, y := 15

```

For More Information:

- On using the LIST and TRUNCATE attributes to specify variable-length parameter lists (Sections 10.2.24 and 10.2.37)
- On scope (Section 7.2)

6.3.9. Default Formal Parameters

VSI Pascal allows you to supply default values for formal parameters. Using default parameter values, you do not need to pass actual parameters. Also, you can specify an actual parameter in the position of a formal parameter whose default value you want to override. To specify a default value, use the following format:

```

parameter-spec := [[mechanism-specifier]] constant-expression;
parameter-spec

```

The parameter specification. The syntax for a parameter specification depends on its semantics.

```
mechanism-specifier
```

The mechanism by which VSI Pascal associates a default value with a formal parameter. You can only specify a mechanism-specifier on a foreign routine.

```
constant-expression
```

A constant expression representing the default value for the formal parameter.

This default value, plus the optional mechanism specifier, must be a legal actual parameter for the kind of formal parameter with which the default is associated. Table 6.4 shows when VSI Pascal allows a default value.

Table 6.4. Default Values on Formal Parameters

Formal Parameter Type	External Routine	VSI Pascal Routine
Variable	Requires foreign mechanism specifier	Error

Formal Parameter Type	External Routine	VSI Pascal Routine
Value	Allowed	Allowed
Routine	Requires foreign mechanism specifier	Error

When you declare a formal parameter with a default value, you can either omit it from the routine call or, if you use positional syntax, you can indicate its position with a comma.

Consider the following example:

```

FUNCTION Net_Pay( Hours      : INTEGER;
                 Tax        : REAL := 0.05;
                 Rate       : REAL;
                 Fica       : REAL := 0.07;
                 Overtime   : INTEGER ) : REAL; {Body...}
{In the executable section:}
{Nonpositional syntax:}
Take_Home_Year := Take_Home_Year +
                 Net_Pay ( Overtime := Overtime_Week,
                         Rate := Pay_Rate,
                         Hours := Hours_Week );
{Positional syntax:}
Take_Home_Year := Take_Home_Year +
                 Net_Pay( Hours_Week, , Pay_Rate, ,
                         Overtime_Week );

```

The formal parameters Tax and Fica are given the default values 0.05 and 0.07, respectively.

You can override a formal parameter's default value by associating the formal parameter with an actual parameter in a routine call. For example, if you want to replace the default value of the formal parameter Tax in the previous example for one call, you can call Net_Pay as follows:

```

Take_Home_Year := Take_Home_Year +
                 Net_Pay( Hours_Week, 0.06, Pay_Rate, , Overtime_Week );

```

As a result of this routine call, the default value of Tax will be replaced by the value 0.06 supplied in the actual parameter list.

For More Information:

- On specifying passing mechanisms (Section 6.3.5)
- On positional and nonpositional syntax of parameters (Section 6.3.8)

Chapter 7. Program Structure and Scope

This chapter describes the following topics:

- Section 7.1: Blocks
- Section 7.2: Scope of Identifiers
- Section 7.3: Redeclaring Routine Names
- Section 7.4: Modules and Programs
- Section 7.5: Compilation Units and Data Sharing

7.1. Blocks

A **block** is a declaration section and an executable section. Programs, modules, and routines are structured in blocks. A declaration section can contain routine blocks nested within the outer program or module block; routine blocks can also be nested within other routines.

The declaration section contains data definitions and declarations, and nested routine declarations that are local to the enclosing block. The executable section contains the statements that specify the block's actions. You can cause an exit from a block with the last executable statement of the block, which causes normal termination, or with a `GOTO` statement, which transfers control to an outer block.

For More Information:

- On declaration sections (Chapter 3)
- On routine declarations (Section 6.1)
- On the `GOTO` statement (Section 5.8)

7.2. Scope of Identifiers

The **scope** of an identifier is the part of the program in which the identifier has a particular meaning. In Pascal, the scope of an identifier is the block in which it is defined or declared, including nested blocks (but excluding any nested blocks that redeclare the same identifier). Outside its scope and assuming that it is not declared elsewhere, an identifier has no meaning; in this case, attempts to use the identifier generate an error.

All Pascal identifiers observe the following scope rules:

- An identifier can be declared only once within a particular scope.
- A previously declared identifier can be redeclared in a nested block.
- An identifier declared in the main program or module block is accessible in all nested blocks (except where it is redeclared).

Some Pascal identifiers observe additional scope rules:

- A procedure identifier can be redeclared within its own declaration section.
- A function identifier can also be redeclared, but not in a declaration section of the function's outermost block. The identifier can be redeclared only in a nested block because you need to be able to assign a value to it in the outermost block unless a RETURN statement is used.
- A formal parameter name follows the same rules of scope as a function identifier and can be redeclared only in a nested block.
- A label declaration must respect GOTO statement restrictions. These restrictions prevent control passing from an outer to an inner block.

7.3. Redeclaring Routine Names

Routine names can be redeclared like any other identifier. A block, in its declaration section, can specify routines with the same names as those outside the block. This changes the meaning of function and procedure calls when they occur within the block.

A procedure can redeclare its own identifier. For example, the declaration section of the procedure Sum can declare a different procedure called Sum. The scope of this second declaration is only within the first block; calls to Sum within the block are not recursive but are calls to the locally declared routine.

You can also redeclare a function identifier within its own declaration. However, the function then cannot use the function identifier in an assignment to return a value to the caller. A function that redeclares its own identifier must use the RETURN statement (see Section 5.12) to specify a return value.

In the declaration section you cannot redeclare an identifier used in the formal parameter list of the routine. However, a block nested in the declaration section can do so. The following example shows the scope of identifiers that appear in several blocks in a program.

Figure 7.1 shows the scope of identifiers that appear in several blocks in a program. Pascal scope rules make the following statements about Figure 7.1 true:

- Variable identifiers a and b are declared at the outer level of the example. Scope rules make them accessible throughout the example. In the main program, Level1a, and Level1b, identifiers a and b represent integers. In Level2, variable identifier a still represents an integer variable, but b is redeclared as a Boolean variable.
- Type identifier c and variable identifiers d and e are declared at the next lower level, Level1a. Scope rules make them accessible only in this block. They cannot be accessed from the higher-level main program. They cannot be accessed from a lower-level block because Level1a contains no nested routine.
- Formal parameter identifiers v, u, and t are declared at the same level, Level1b. They cannot be redeclared within this block. They can be redeclared as local identifiers in the nested block of FUNCTION Level2.
- Procedure identifier Level1a is declared in the outermost block of the example. This identifier can be redeclared within its own declaration section.
- Function identifier Level2 is declared in the next-highest level, Level1b. It cannot be declared within this block. Level2 can be redeclared as a local identifier within a nested block.

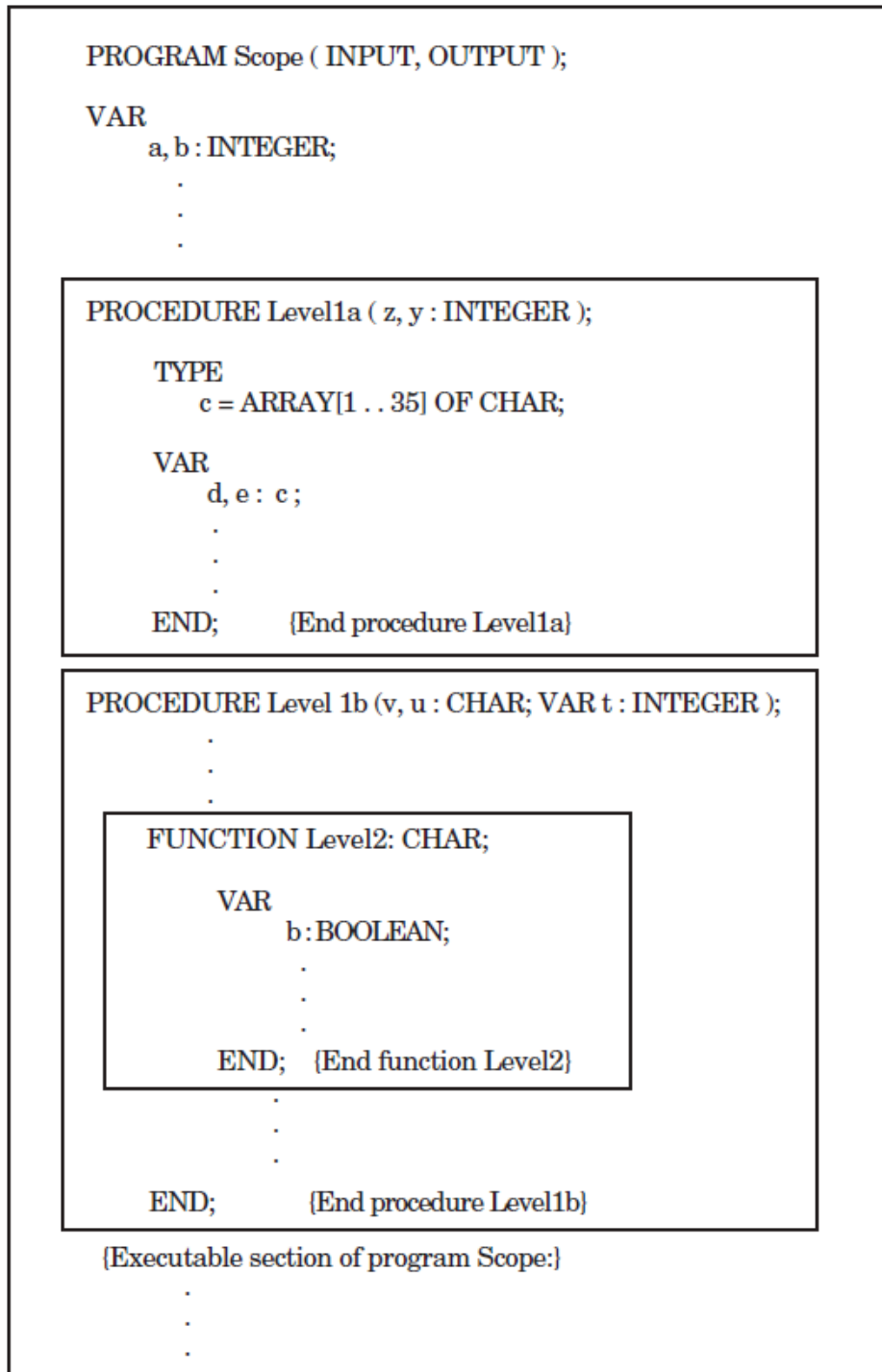
Figure 7.1. Scope of Identifiers

ZK-1112A-GE

For More Information:

- On scope of routine identifiers (Section 6.1)
- On scope of formal parameters (Section 6.3)
- On scope of labels and GOTO statements (Section 5.8)

7.4. Modules and Programs

A **module** is a set of instructions that can be compiled, but not executed, by itself. Module blocks contain only a declaration section and TO BEGIN DO and TO END DO sections. A **program** is a set of instructions that can be compiled and executed by itself. Program blocks contain a declaration and an executable section. A **compilation unit** is a unit of VSI Pascal code that can be compiled independently; the term compilation unit refers to either a program or a module.

Each module and program must be in a separate file; you cannot place multiple modules (or a module and a program) in the same file. You can compile modules and a program together or separately (the syntax of compilation depends on the operating system you are using).

The formats for compilation units are as follows:

```
[[attribute-list]] PROGRAM comp-unit-identifier [[({file-
identifier},...)]];
  [[declaration-section]]
  BEGIN
  {statement};...
  END.
```

```
[[attribute-list]] MODULE comp-unit-identifier
  [[({file-identifier},...)]];
  [[declaration-section]]
  [[TO BEGIN DO statement;]]
  [[TO END DO statement;]]
  END.
```

The module syntax of VSI Pascal is slightly different than that of Extended Pascal. However, the concepts in both languages are the same.

`attribute-list`

One or more identifiers that provide additional information about the compilation unit.

`comp-unit-identifier`

Specifies the name of the program or module. The identifier appears only in the heading and has no other purpose within the compilation unit.

`file-identifier`

Specifies the names of any file variables associated with the external files used by the compilation unit.

`declaration-section`

A Pascal declaration section.

`statement`

A Pascal statement.

The program or module heading includes all information preceding the program or module block. If your program contains any input or output routines, you must list all the external file variables that you are using in the compilation unit's heading. File variables listed in a heading must also be declared locally

in the block, except for the predeclared file variables INPUT and OUTPUT. The INPUT identifier corresponds to a predefined external file that accepts input from the default device (usually, your terminal). The OUTPUT identifier corresponds to a predefined external file that sends output to the default device (usually, your terminal). The ERR identifier corresponds to the default error device. If you redeclare INPUT and OUTPUT in a nested block, you lose access to the default input and output devices.

Consider the following example:

```
PROGRAM Write_Var(OUTPUT);    {Header}
VAR                           {Declaration section}
    Number : INTEGER VALUE 3;
BEGIN                          {Executable section}
WRITELN( Number );           {Writes 3 to the default device}
END.
```

For More Information:

- On INPUT and OUTPUT (Section 9.5)
- On compilation and command-line syntax (*VSI Pascal for OpenVMS User Manual*)
- On the TO BEGIN DO section (Section 3.3)
- On the TO END DO section (Section 3.4)

7.5. Compilation Units and Data Sharing

When dividing code into programs and modules, you may want to share declarations among compilation units. The following sections discuss ways of sharing data.

7.5.1. Environment Files

Environment files contain the definitions and declarations, from the outermost level of declaration section of a compilation unit, that can be shared with other compilation units that inherit the environment file. Environment files exist in a form that the compiler can process more easily. The following example shows how to use environment files:

```
{Contained in one file:}
[INHERIT ('file_name')]
PROGRAM a( INPUT, OUTPUT );
BEGIN
READ( Amount );
Calc;
WRITELN( 'Purchase Amount: ', Amount:10:2)
WRITELN( '          + ', Tax:10:2)
WRITELN( 'Pay This Total: ', Total:10:2)
END.
```

```
{Contained in a separate file:}
[ENVIRONMENT('file_name')]
MODULE B;           {Keep all global data in one module}
CONST              {Compile this unit first to create file}
    Rate = 0.06;
VAR
    Amount, Total, Tax: REAL;
```

```
PROCEDURE G1f; BEGIN...END;
PROCEDURE Calc;
  BEGIN
  Tax := Amount * Rate;
  Total := Tax + Amount;
  G1f;
  END;
END.
```

Since the declarations in module b compose the environment file to be inherited by another compilation unit, you must compile module b first to create the environment file. When compiling module b, VSI Pascal creates an environment file by the name of file_name. VSI Pascal adds a file type of .PEN (for Pascal Environment).

The environment file contains declaration information about the constant Rate; about the variables Amount, Total, and Tax; and about the procedures G1f and Calc. If there are identifiers in a compilation unit that you do not want to be included in an environment file, use the `HIDDEN` attribute.

When you compile program a, which contains the `INHERIT` attribute, VSI Pascal uses the specified environment file to allow the program access to the data and routines declared in the module. Variables that are inherited from an environment file are not newly created variables, but are the same variables that were allocated storage by the declaring compilation unit.

A compilation unit may create only one environment file, but may inherit multiple files that must have been created by earlier compilations. Declarations from inherited files are not included in any environment files created by the compilation unit. An environment file must have been created by a version of the compiler that is compatible with the version that is compiling the compilation unit.

The identifiers in the outermost level of the declaration section of a compilation unit and all inherited identifiers must be unique. However, VSI Pascal allows the following exceptions to the redeclaration rules:

- A variable identifier can be multiply declared if all declarations of the variable have the same type, and all but one declaration at most are external.
- A procedure identifier can be multiply declared if all declarations of the procedure have congruent parameter lists, and all but one declaration at most are external.
- A function identifier can be multiply declared if all declarations of the function have congruent parameter lists and identical result types, and all but one declaration at most are external.

Consider the following example:

```
{In one compilation unit:}
[ENVIRONMENT('extern.pen')] MODULE Mod1;
[EXTERNAL] PROCEDURE Inst; EXTERN;
END.
```

```
{In another compilation unit:}
[INHERIT('extern.pen')] MODULE Mod2;
[GLOBAL] PROCEDURE Inst; {Body...}
END.
```

For More Information:

- On the `ENVIRONMENT` attribute (Section 10.2.14)

- On the INHERIT attribute (Section 10.2.21)
- On the HIDDEN attribute (Section 10.2.18)
- On declaration sections (Chapter 3)

7.5.2. Global and External Identifiers

Global and external identifiers are accessible to other compilation units (even to compilation units written in other languages) that make up one executable unit. The GLOBAL attribute allows a declared identifier to be globally accessible by other compilation units; the EXTERNAL attribute specifies that another compilation unit allocates storage for the data or routine. The compiler does not check to make sure that global and external identifiers are declared as being of the same data type; you must ensure that the data types are compatible.

You cannot use global and external names to share the declarations of user-defined types. However, you can use the VALUE attribute to share global and external literals.

The following example shows how to use global and external identifiers:

```
{Contained in one file:}
PROGRAM a( INPUT, OUTPUT );
VAR
    Amount, Total, Tax : [EXTERNAL] REAL;    {Defined elsewhere}
    [EXTERNAL] PROCEDURE Calc; EXTERNAL;    {Defined elsewhere}
    [GLOBAL] PROCEDURE Glf; {Body...}       {Available outside}
BEGIN
    READ( Amount );
    Calc;
    WRITELN( 'Purchase Amount: ', Amount:10:2)
    WRITELN( '          + ', Tax:10:2)
    WRITELN( 'Pay This Total: ', Total:10:2)
END.
```

```
{Contained in a separate file:}
MODULE B;
CONST
    Rate = 0.06;
VAR
    Amount, Total, Tax: [GLOBAL] REAL; {Available outside}
    [EXTERNAL] PROCEDURE Glf; EXTERNAL; {Defined elsewhere}
    [GLOBAL] PROCEDURE Calc;           {Available outside}
    BEGIN
        Tax := Amount * Rate;
        Total := Tax + Amount;
        Glf;
    END;
END.
```

The file containing the module can be compiled separately from the file containing the program.

For More Information:

- On the GLOBAL attribute (Section 10.2.17)
- On the EXTERNAL attribute (Section 10.2.15)

Chapter 8. Predeclared Functions and Procedures

VSI Pascal supplies predeclared procedures and functions that perform various commonly used operations. You do not have to declare these routines in order to call them from your code.

In this chapter, the routines are presented in alphabetical order. To save you the time of scrolling through all the routines, you may wish to click on the Table Of Contents entry for the desired routine.

Also in this chapter, the term arithmetic types refers to those data types you can use in arithmetic operations: the integer, unsigned, and real types.

In some sections of this manual, reference is made to entire categories of routines. Table 8.1 lists the routines in each category.

Table 8.1. Predeclared Routine Categories

Category	Category Description and Routines
Allocation size	Routines that provide information about the amount of storage allocated for variables and for components of various types: BITNEXT, BITSIZE, NEXT, and SIZE
Arithmetic	Routines that perform mathematical computations: ABS, ARCTAN, CARD, COS, EXP, EXPO, LN, LSHIFT, RSHIFT, MAX, MIN, RANDOM, SEED, SIN, SQR, SQRT, UNDEFINED, UAND, UNOT, UOR, UXOR, and XOR
Character-string	Routines that manipulate character strings: BIN, DEC, EQ, FIND_MEMBER, FIND_NONMEMBER, GE, GT, HEX, INDEX, LE, LENGTH, LT, NE, OCT, PAD, READV, STATUSV, SUBSTR, UDEC, and WRITEV
Component position	Routines that provide information about the offset of record components: BIT_OFFSET and BYTE_OFFSET
Condition handling	ASSERT, ESTABLISH, HALT, REVERT
Date-time	Routines that provide information on the calendar date and time: CLOCK, DATE, GETTIMESTAMP, SYSCLOCK, TIME, and WALLCLOCK
Dynamic allocation	Routines that provide for the creation and use of pointer variables: ADDRESS, DISPOSE, IADDRESS, IADDRESS64, and NEW
File operations	Routines that create, rename, and remove files and directories: CREATE_DIRECTORY, DELETE_FILE, RENAME_FILE
Input and Output	Routines that you use for I/O; these routines are not described in this chapter
Low-level	Routines that allow for parallel processes and for asynchronous routines to operate in a real-time or multitasking environment: ADD_ATOMIC, AND_ATOMIC, ADD_INTERLOCKED, BARRIER, CLEAR_INTERLOCKED, OR_ATOMIC and SET_INTERLOCKED
Null-terminated strings	Routines that operate on null-terminated strings: C_STR, MALLOC_C_STR, PAS_STRCPY, PAS_STR
Ordinal	Routines that provide information on the ordered sequence of values: PRED, SUCC, LOWER and UPPER, ODD

Category	Category Description and Routines
Parameter	Routines that give information about parameter lists: ARGC, ARGV, ARGUMENT, ARGUMENT_LIST_LENGTH, and PRESENT
Privileged ("OpenVMS VAX systems only")	Routines that manipulate privileged hardware registers: MFPR and MTPR
Type conversion	Routines that convert an actual parameter to data of another type: CHR, DBLE, INT, INT64, ORD, PACK, QUAD, ROUND, ROUND64, SNGL, TRUNC, TRUNC64, UINT, UINT64, UNPACK, UROUND, UROUND64, UTRUNC, and UTRUNC64
Miscellaneous	FIND_FIRST_BIT_CLEAR, FIND_FIRST_BIT_SET, UNDEFINED, and ZERO

Note

Not all routines are supported on all operating system and machine architecture environments. If a routine is not supported on all environments, the routine description includes any limitations.

For More Information:

- On data types (Chapter 2)
- On ordinal types (Section 2.1)
- On pointers (Section 2.3)
- On arrays and records (Section 2.4)
- On parameter lists (Section 6.3)
- On input and output routines (Section 9.8)
- On data storage (Appendix A)

8.1. ABS Function

The ABS function returns a value (of the same data type as the specified parameter) that is the absolute value of the parameter.

```
ABS ( x )
```

The parameter *x* can be of any arithmetic type.

8.2. ADD_ATOMIC Function (OpenVMS I64 and OpenVMS Alpha systems only)

The ADD_ATOMIC function adds the value of an expression to the value of a variable, stores the newly computed value in the variable, and returns the previous value of the variable.

```
ADD_ATOMIC ( e, v )
```

The type of the expression *e* must be assignment compatible with that of the variable *v*. The variable *v* must be an `INTEGER`, `UNSIGNED`, `INTEGER64`, or `UNSIGNED` variable and must be allocated on a natural boundary, such as longword for `INTEGER` and `UNSIGNED` and quadword for `INTEGER64` and `UNSIGNED64`. The result of `ADD_ATOMIC` is the same type as the variable *v*.

Overflow and subrange checking are never performed on the `ADD_ATOMIC` operation, even if these options are in effect for the rest of the function or compilation unit.

The `ADD_ATOMIC` function does not provide memory synchronization between multiple processors. The `BARRIER` predeclared routine must be used for that purpose.

This function is used to access data that is shared between two or more threads of execution.

For More Information

- On atomic operations (*VSI Pascal for OpenVMS User Manual*)

8.3. `ADD_INTERLOCKED` Function

The `ADD_INTERLOCKED` function adds the value of an expression to the value of a variable, stores the newly computed value in the variable, and returns an integer value: -1 if the new value is negative, 0 if it is zero, and 1 if it is positive.

```
ADD_INTERLOCKED ( e, v )
```

The type of the expression *e* must be assignment compatible with that of the variable *v*. The variable *v* must be an integer or an unsigned subrange; *v* must have an allocation size of two bytes and must be aligned on a word boundary. The type of *e* must be assignment compatible with that of *v*.

Note that unless the type of *v* is an integer subrange that includes negative values, the result of the `ADD_INTERLOCKED` function is never -1.

Overflow and subrange checking are never performed on the `ADD_INTERLOCKED` operation, even if these options are in effect for the rest of the function or compilation unit.

This function is used to access data that is shared between two or more threads of execution.

For More Information

- On atomic operations (*VSI Pascal for OpenVMS User Manual*)

8.4. `ADDRESS` Function

The `ADDRESS` function returns a pointer value that is the address of the parameter.

```
ADDRESS ( x )
```

The parameter *x* can be a variable of any type except a component of a packed structured type. A compile-time warning results if *x* is a formal `VAR` parameter, a component of a formal `VAR` parameter, or a variable that does not have the `READONLY` or `VOLATILE` attribute.

A pointer can only refer to a `VOLATILE` variable or a variable allocated by the `NEW` procedure.

For More Information:

- Pointer data types (Section 2.3)
- On the VOLATILE attribute (Section 10.2.42)
- On the NEW procedure (Section 8.58)

8.5. AND_ATOMIC Function (OpenVMS I64 and OpenVMS Alpha systems only)

The AND_ATOMIC function logically ANDs the value of an expression to the value of a variable, stores the newly computed value in the variable, and returns the previous value of the variable.

```
AND_ATOMIC ( e, v )
```

The type of the expression *e* must be assignment compatible with that of the variable *v*. The variable *v* must be an INTEGER, UNSIGNED, INTEGER64, or UNSIGNED64 variable and must be allocated on a natural boundary, such as longword for INTEGER and UNSIGNED and quadword for INTERGER64 and UNSIGNED64. The result of AND_ATOMIC is the same type as the variable *v*.

The AND_ATOMIC function does not provide memory synchronization between multiple processors. The BARRIER predeclared routine must be used for that purpose.

This function is used to access data that is shared between two or more threads of execution.

For More Information

- On atomic operations (*VSI Pascal for OpenVMS User Manual*)

8.6. ARCTAN Function

The ARCTAN function returns a real value that expresses in radians the arctangent of the specified parameter.

```
ARCTAN ( x )
```

The parameter *x* can be an integer or REAL type.

8.7. ARGUMENT Function

The ARGUMENT function specifies an argument in a variable-length parameter list that was created using the LIST attribute.

```
ARGUMENT ( parameter-name, n )
```

The parameter-name argument specifies the name of a parameter declared with the LIST attribute. The parameter *n* specifies a positive integer value that identifies the argument. The first argument in a list is always 1. An error occurs if the value supplied for *n* is less than 1, or exceeds the ARGUMENT_LIST_LENGTH parameter (which indicates the total number of arguments).

If the LIST parameter is a value parameter, ARGUMENT indicates the corresponding value in the argument list. If the LIST parameter is a VAR parameter, ARGUMENT is a reference to the corresponding variable in the argument list.

Also, you can use the IADDRESS function with the ARGUMENT function to return the address of a selected argument.

For More Information:

- On variable-length parameter lists (the example in Section 8.8)
- On parameters (Section 6.3)
- On the LIST attribute (Section 10.2.24)
- On the IADDRESS function (Section 8.42)

8.8. ARGUMENT_LIST_LENGTH Function

The ARGUMENT_LIST_LENGTH function returns an integer value representing the number of arguments in a variable-length parameter list that was created using the LIST attribute.

```
ARGUMENT_LIST_LENGTH( parameter-name )
```

The parameter-name argument specifies the name of the parameter declared with the LIST attribute.

When creating a variable-length parameter list, you can place the LIST attribute on only the last formal parameter. When you call the routine, you can specify any number of actual parameters, or arguments, that correspond to the last formal parameter declared with LIST. Consider the following example.

```
PROGRAM Show_Arg( OUTPUT );
    {Ax corresponds to any number of char. arguments}
PROCEDURE Variable_Write( Fl : VARYING[len] OF CHAR;
    Ax : [LIST] CHAR );
    VAR
        i : INTEGER;
    BEGIN
        WRITE( Fl, ', ' );
        {For however many arguments there are:}
        FOR i := 1 TO ARGUMENT_LIST_LENGTH( Ax ) DO
            WRITE( ARGUMENT( Ax, i ) );           {Write an argument}
        WRITELN;
    END;
{In the executable section:}
Variable_Write( ' hello', '*' ); {One argument: Writes ' hello, *'}
Variable_Write( ' hello','s','a','i','l','o','r','!' );
    {Seven arguments: Writes ' hello, sailor!'}
```

For More Information:

- On parameters (Section 6.3)
- On the LIST attribute (Section 10.2.24)

8.9. ASSERT Procedure

The ASSERT procedure signals a run-time error if the value of its parameter is FALSE. ASSERT takes this form:

```
ASSERT(expression [[, string]])
```

The parameter expression is a Boolean expression that is normally true. If ASSERT evaluates the expression as false, it signals a run-time error indicating that the assertion failed.

The optional string parameter is output as part of the error message.

8.10. BARRIER Function (OpenVMS I64 and OpenVMS Alpha systems only)

The BARRIER procedure causes a memory barrier instruction to be emitted to synchronize pending memory updates in a multi-processor environment.

```
BARRIER
```

The BARRIER procedure has no parameters.

This routine is used to serialize memory writes on VSI OpenVMS I64 and VSI OpenVMS Alpha systems.

For More Information

- On memory granularity (*VSI Pascal for OpenVMS User Manual*)

8.11. BIN Function

The BIN function returns a character-string value that is the binary equivalent of the specified parameter. The return value is compatible with all other string types.

```
BIN( x[[, length[[, digits]] ]] )
```

The parameter x is the expression to be converted. This parameter must have a size that is known at compile time; it cannot be VARYING OF CHAR, a conformant parameter, or a schema type.

Two optional integer parameters specify the length of the resulting string and the minimum number of significant digits to be returned. If you specify a length that is too short to hold the converted value, the resulting string is truncated on the left.

If you omit the optional parameters, the bit width of the converted parameter value determines the string length and the number of significant digits. By default, the number of significant digits is the minimum number of characters necessary to express all the bits of the converted parameter. This default length is one character more than the default number of digits, which causes a leading blank to be included in the resulting string when both parameters are omitted. Consider the following example:

```
TYPE
    Month_Dates = SET OF 0..31;
VAR
    Days_Of_Rain : Month_Dates;
{In the executable section:}
Days_Of_Rain := [1, 2, 6, 10, 12, 14, 18, 22, 25, 30];
```

```
Result := BIN (Days_Of_Rain, 32);  
{Returns '01000010010001000101010001000110', 32 characters}
```

The binary representation is from right to left, with the leftmost bit being bit 31 and the rightmost bit being bit 0.

For More Information:

- On character strings (Section 2.6)
- On conformant parameters (Section 6.3.7)

8.12. BIT_OFFSET Function

The BIT_OFFSET function returns an integer value that represents the bit position of a field in a record.

```
BIT_OFFSET( t, f )
```

The parameter *t* can be of any record type or variable, and the parameter *f* can be any field contained in that record.

For More Information:

On records (Section 2.4.2)

8.13. BITNEXT Function

The BITNEXT function returns an integer value that indicates the number of bits that would be allocated for one component of the specified type in a packed array or if the specified variable appeared as a cell in a packed array.

```
BITNEXT( x )
```

The parameter *x* can be a variable or any type identifier.

Cells in a packed array are affected by any alignment attributes placed on them. Therefore, the size returned includes the actual size of the type or variable in addition to trailing space required to ensure proper alignment.

The BITNEXT and BITSIZE functions return the same bit size for a given type or variable, except where the components of the packed array are padded to ensure proper alignment.

For More Information:

- On examples of return values for this function (Table 8.2)
- On packed arrays (Section 2.4)

8.14. BITSIZE Function

The BITSIZE function returns an integer value that indicates the number of bits that would be allocated for one field of the specified type in a packed record or if the specified variable appeared as a field in a packed record.

`BITSIZE (x)`

The parameter `x` can be a variable or any type identifier.

Fields in a packed record are not affected by any alignment attributes placed on subsequent fields. Therefore, the size returned indicates the actual size of the type or variable.

The `BITNEXT` and `BITSIZE` functions return the same bit size for a given type or variable, except where the components of the packed array are padded to ensure proper alignment.

For More Information:

- On possible return values for this function (Table 8.2)
- On packed arrays (Section 2.4)

8.15. `BYTE_OFFSET` Function

The `BYTE_OFFSET` function returns an integer value that represents the byte position of a field in a record.

`BYTE_OFFSET (t, f)`

The parameter `t` can be of any record type or variable, and the parameter `f` can be any field contained in that record.

For More Information:

- On records (Section 2.4.2)

8.16. `C_STR` Function

The `C_STR` function takes a compile-time string expression and returns a `C_STR_T` pointer to a static string literal with a terminating null character.

`C_STR (e)`

The `C_STR` function can also accept a Pascal variable of either `PACKED ARRAY OF CHAR`, `VARYING OF CHAR`, or `STRING`.

`C_STR (v)`

In this form, it will return a `C_STR_T` value that represents the first character in the string variable. It does not ensure a terminating null byte. The programmer must handle the null-termination to treat a Pascal string variable as a null-terminated string.

8.17. `CARD` Function

The `CARD` function returns an integer value indicating the number of components that are currently elements of the set expression.

`CARD (s)`

The parameter `s` must be a set expression.

For More Information:

- On sets (Section 2.4.3)

8.18. CHR Function

The CHR function returns a char value whose ordinal value in the ASCII character set is the parameter, provided such a character exists.

CHR (*x*)

The parameter *x* must be integer or unsigned and have a value from 0 to 255.

For More Information:

- On the ASCII character set (Section 1.2.1)

8.19. CLEAR_INTERLOCKED Function

The CLEAR_INTERLOCKED function assigns the value FALSE to the parameter and returns the original Boolean value of the parameter.

CLEAR_INTERLOCKED (*b*)

The parameter *b* must be a variable of type BOOLEAN. The variable does not have to be aligned; therefore, it can be a field of a packed record.

This function is used to access data that is shared between two or more threads of execution.

For More Information

- On atomic operations (*VSI Pascal for OpenVMS User Manual*)

8.20. CLOCK Function

The CLOCK function returns an integer value indicating the amount of central processor time (in milliseconds) used by the current process. This function does not have a parameter list. The result of CLOCK includes the amount of central processor time allocated to all previously executed images.

8.21. COS Function

The COS function returns a real value that represents the cosine of the specified parameter.

COS (*x*)

The parameter *x* can be an integer or REAL type, and is expressed in radians.

8.22. CREATE_DIRECTORY Procedure

The CREATE_DIRECTORY procedure creates a new directory or subdirectory.

```
CREATE_DIRECTORY( file-name [[, error-return]] )
```

The file-name parameter must be a directory name, and optionally can contain a device name. The error-return parameter is optional, and will return an error recovery code if specified.

For More Information:

- On error recovery codes (*VSI Pascal for OpenVMS User Manual*)

8.23. DATE and TIME Functions

The DATE and TIME functions provide a standard way of returning a character-string value that indicates the calendar date and time. The return value is compatible with all string types.

```
DATE( t )
TIME( t )
```

The parameter t is a variable of the predeclared type `TIMESTAMP`. You can either call the `GETTIMESTAMP` procedure to initialize parameter t before you pass t to either DATE or TIME, or you can construct your own `TIMESTAMP` object.

The size of the function's return value depends on the string length that is normally returned by your system for either date or time data. Consider the following example:

```
VAR
    Time_Var : TIMESTAMP;
    The_Time, The_Date : STRING( 23 );
{In the executable section:}
GETTIMESTAMP( Time_Var );
The_Date := DATE( Time_Var );
The_Time := TIME( Time_Var );
WRITELN( The_Date, The_Time ); {Writes: 15-JUL-1992 14:20:25.98}
```

For More Information:

- On the `GETTIMESTAMP` predeclared procedure (Section 8.38)
- On the layout of the `TIMESTAMP` type (Section 2.8)

8.24. DATE and TIME Procedures

The DATE and TIME procedures write the date and the time to their parameters.

```
DATE( str )
TIME( str )
```

The parameter str must be of type `PACKED ARRAY[1..11] OF CHAR`. After execution of the procedure, the parameter str contains either the date or the time. If the day of the month is a 1-digit number, the leading zero does not appear in the result; that is, a space appears before the date string. The time is returned in 24-hour format.

For More Information:

- On standard ways to obtain the date and the time (Section 8.23)

8.25. DBLE Function

The DBLE function converts the parameter and returns its DOUBLE equivalent.

```
DBLE ( x )
```

The parameter *x* must be of an arithmetic type. The value of *x* must not be too large to be represented by a double-precision number.

For More Information:

- On precision and support for the DOUBLE data type (Chapter 2)

8.26. DEC Function

The DEC function returns a character-string value that is the decimal equivalent of the specified parameter. The return value is compatible with all other string types.

```
DEC ( x[[, length[[, digits]] ]] )
```

The parameter *x* is the expression to be converted. The DEC function can take a parameter of any type except VARYING OF CHAR, conformant parameters, or schema types. The DEC function requires the size of *x* to be less than or equal to the size of INTEGER64 (if supported), or less than or equal to the size of INTEGER32.

Two optional integer parameters specify the length of the resulting string and the minimum number of significant digits to be returned. If you specify a length that is too short to hold the converted value, the resulting string is truncated on the left. If you do not specify values for the optional parameters, a default length and a default minimum number of significant digits is used.

If the size of *x* is greater than 32, the defaults are 20 characters for the length and 19 characters for the minimum number of digits. Otherwise, the defaults are 11 characters for the length and 10 characters for the minimum number of digits. Because the default length is 1 greater than the number of significant digits, positive numbers will be preceded by a blank and negative numbers will be preceded by a minus sign. Consider the following example.

```
VAR
  Account : INTEGER;
{In the executable section:}
Account := 16#F;
WRITELN( DEC( Account, 8, 7 ) );
```

The value of the integer variable *Account* is converted to its decimal equivalent (15) and, in this example, printed in eight columns: seven digits, and one leading blank (0000015).

For More Information:

- On character strings (Section 2.6)
- On conformant parameters (Section 6.3.7)

8.27. DELETE_FILE Procedure

The DELETE_FILE procedure deletes one or more files.

```
DELETE_FILE( file-name [[, error-return]] )
```

The file-name specification can contain an explicit device and directory name, plus it must contain a file name, a file type or extension, and a version number. If you omit either the directory or device name, VSI Pascal uses the directory you are working in at the time of program execution.

The error return parameter returns an error recovery code if specified.

For More Information:

- On error recovery codes (*VSI Pascal for OpenVMS User Manual*)

8.28. DISPOSE Procedure

The DISPOSE procedure deallocates memory for a dynamic variable.

```
DISPOSE( p [[, t1, ..., tn]] )
```

The parameter p is a pointer expression. The t parameters are constant expressions that match the corresponding t parameter used in the call to the NEW procedure that allocated the memory. If you use t parameters in a call to NEW, you must specify the same t parameters in the call to DISPOSE. If you allocated memory using d parameters, just specify the pointer variable to the corresponding DISPOSE call.

The DISPOSE procedure deallocates the object to which the pointer variable points. You cannot call DISPOSE more than once for the same dynamic variable. Consider the following example:

```
DISPOSE( Ptr ); {Ptr^ is destroyed; Ptr becomes undefined}
```

For More Information:

- On the pointer data types (Section 2.3)
- On the NEW procedure (Section 8.58)

8.29. EQ Function

The EQ function returns a Boolean value that specifies if the parameters are equal according to the ASCII values of the strings' characters.

```
EQ(str1, str2)
```

The parameters str1 and str2 must be character-string expressions. If the EQ function detects unequal string lengths, it stops comparison and returns FALSE. Consider the following example:

```
VAR
  Match : BOOLEAN;
{In the executable section:}
Match := EQ( 'exit  ', 'exit' ); {Returns FALSE; unequal lengths}
Match := EQ( 'exit', 'exit' );   {Returns TRUE}
```

For More Information:

- On string data types (Section 2.6)

8.30. ESTABLISH Procedure

The ESTABLISH procedure specifies a condition handler that executes if your program generates operating-system events.

```
ESTABLISH( function-identifier )
```

The function-identifier parameter must be the name of a function that has the ASYNCHRONOUS attribute and must return an integer value.

For More Information:

- On the ASYNCHRONOUS attribute (Section 10.2.3)
- On error and report processing (*VSI Pascal for OpenVMS User Manual*)

8.31. EXP Function

The EXP function returns a real value that represents the exponent of the specified parameter (it represents e^x).

```
EXP ( x )
```

The parameter x can be an integer or REAL type.

8.32. EXPO Function

The EXPO function returns the integer exponent of the floating-point representation of the parameter.

```
EXPO ( x )
```

The parameter x can be of any real type.

For More Information:

- On precision and support for real numbers (Chapter 2)

8.33. FIND_FIRST_BIT_CLEAR Function

The FIND_FIRST_BIT_CLEAR function locates the first bit in a Boolean array whose value is 0 and returns an integer value that specifies the index into the array.

```
FIND_FIRST_BIT_CLEAR( vector [[, start-index]] )
```

The vector parameter is a variable of type PACKED ARRAY OF BOOLEAN with an integer index type. The optional start-index parameter must be an integer expression that indexes the element at the point at

which the search starts. The starting index must be greater than or equal to the vector's lower bound, and less than or equal to 1 plus the vector's upper bound; otherwise, a range violation occurs. If omitted, the starting index defaults to the vector's first element.

This function returns a value indexing the first element containing the value 0. If no bit is 0, the result is 1 plus the vector's upper bound. If the vector or the indexed part of the vector has a size of 0, the result is start-index.

8.34. FIND_FIRST_BIT_SET Function

The FIND_FIRST_BIT_SET function locates the first bit in a Boolean array whose value is 1 and returns an integer value that specifies the index into the array.

```
FIND_FIRST_BIT_SET( vector [[, start-index]] )
```

The vector parameter is a variable of type PACKED ARRAY OF BOOLEAN with an integer index type. The optional start-index parameter must be an expression of an integer type that indexes the element at the point at which the search starts. The starting index must be greater than or equal to the vector's lower bound, and less than or equal to 1 plus the vector's upper bound; otherwise, a range violation occurs. If omitted, the starting index defaults to the vector's first element.

The FIND_FIRST_BIT_SET function returns an integer value indexing the first element containing the value 1. If no bit is 1, the result is 1 plus the vector's upper bound. If the vector or the indexed part of the vector has a size of 0, the result is start-index. Consider the following example:

```
VAR
  Boo : PACKED ARRAY [0..31] OF BOOLEAN;
{In the executable section:}
Boo::INTEGER := 128;
WRITELN( FIND_FIRST_BIT_SET( BOO ) );
```

For More Information:

- On the type cast operator (::) (Section 4.2.6)

8.35. FIND_MEMBER Function

The FIND_MEMBER function locates the first character in a string that is a member of a specified set and returns an integer value indicating the position of the character in the string; the function returns 0 if the characters in the string were not members of the set.

```
FIND_MEMBER( string, char-set )
```

The string parameter is a string value, and char-set is a value of type SET OF CHAR.

For More Information:

- On string types (Section 2.6)
- On sets (Section 2.4.3)

8.36. FIND_NONMEMBER Function

The `FIND_NONMEMBER` function locates the first character in a string that is not a member of a specified set and returns an integer value indicating the position of the character in the string; the function returns 0 if the characters in the string were all members of the set.

```
FIND_NONMEMBER( string, char-set )
```

The string parameter is a string value, and char-set is a value of type SET OF CHAR.

For More Information:

- On string types (Section 2.6)
- On sets (Section 2.4.3)

8.37. GE Function

The `GE` function returns a Boolean value that specifies if the first parameter is greater than or equal to the second parameter, according to the ASCII values of the strings' characters.

```
GE( str1, str2 )
```

The parameters `str1` and `str2` must be character-string expressions. VSI Pascal does not pad shorter strings with blanks. Consider the following example:

```
VAR
  Match : BOOLEAN;
  Test   : STRING(8) VALUE 'ENTRANCE';
{In the executable section:}
Match := GE( 'exit', 'exit' );    {Returns TRUE}
Match := GE( Test, 'EXIT' );     {'N' less-than 'X': Returns FALSE}
```

For More Information:

- On string data types (Section 2.6)

8.38. GETTIMESTAMP Procedure

The `GETTIMESTAMP` procedure initializes its parameter for use with the `DATE` and `TIME` functions.

```
GETTIMESTAMP( t [[, str]] )
```

The parameter `t` is a variable of the `TIMESTAMP` type, which is a predeclared record type.

The parameter `str` is a string type that represents a date or both a date and time. The following rules apply to the specification of the `str` parameter:

- If you do not specify the parameter `str`, the `GETTIMESTAMP` procedure initializes the variable to be the date and time at execution of the procedure.
- If you specify an invalid date, the `GETTIMESTAMP` procedure sets the date to be January 1, 1. If you omit the date, this procedure uses the current date. If you specify an invalid time or if you omit the time, it sets the time to be midnight.

Consider the following example:

```
VAR
    Time_Var : TIMESTAMP;
    The_Time, The_Date : STRING( 23 );
{In the executable section:}

GETTIMESTAMP( Time_Var );    {Get current date and time}
GETTIMESTAMP( Time_Var, '22-Nov-1988 12:30:15.15');
GETTIMESTAMP( Time_Var, '22-Nov-1988' ); {Midnight at that date}
GETTIMESTAMP( Time_Var, '41-Nov-1988 999:999:999.99' );
{Invalid date; sets TIME_VAR to midnight on January 1, 1}
```

You can also use predefined values like `TOMORROW`, as shown in this example:

```
GETTIMESTAMP( Time_Var, 'TOMORROW' ); {Midnight tomorrow}
```

For More Information:

- On the `DATE` and `TIME` functions (Section 8.23)
- On the layout of the `TIMESTAMP` type (Section 2.8)

8.39. GT Function

The `GT` function returns a Boolean value that specifies if the first parameter is greater than the second parameter, according to the ASCII values of the strings' characters.

```
GT( str1, str2 )
```

The parameters `str1` and `str2` must be character-string expressions. VSI Pascal does not pad shorter strings with blanks. Consider the following example:

```
VAR
    Match : BOOLEAN;
    Test   : STRING( 8 ) VALUE 'ENTRANCE';
{In the executable section:}
Match := GT( 'exit', 'exit' );    {Returns FALSE}
Match := GT( Test, 'EXIT' );     {'N' less-than 'X': Returns FALSE}
```

For More Information:

- On string data types (Section 2.6)

8.40. HALT Procedure

The `HALT` procedure uses operating system resources to stop execution of your program unless you have written a condition handler (using the `ESTABLISH` procedure) that enables continued execution.

For More Information:

- On the `ESTABLISH` procedure (Section 8.30)

8.41. HEX Function

The HEX function returns a character-string value that is the hexadecimal equivalent of the specified parameter. The return value is compatible with all other string types.

```
HEX( x[[, length[[, digits]] ]] )
```

The parameter *x* is the expression to be converted. This parameter must have a size that is known at compile time; it cannot be VARYING OF CHAR, a conformant parameter, or a schema type.

Two optional integer parameters specify the length of the resulting string and the minimum number of significant digits to be returned. If you specify a length that is too short to hold the converted value, the resulting string is truncated on the left. If you do not specify values for the optional parameters, a default length and a default number of significant digits is used. By default, the number of significant digits is the minimum number of characters necessary to express all the bits of the converted parameter. This default length is one character more than the default number of digits, which causes a leading blank to be included in the resulting string when both parameters are omitted. Consider the following example:

```
VAR
  p : ^Rec;
{In the executable section:}
Digits := 8;
NEW( p );
Result := HEX( p, 10, Digits );
```

In this example, the HEX function returns a string of 10 characters containing the hexadecimal equivalent of the value of the pointer variable *p*. The string has eight significant digits, as specified by the value of the actual parameter *Digits*.

8.42. IADDRESS Function

The IADDRESS function returns an INTEGER_ADDRESS value that refers to the address of either a constant or VOLATILE variable, or parameter, or a routine. IADDRESS does not generate compile-time warnings about volatility (as does the ADDRESS function). The IADDRESS function is commonly used for constructing arguments for system services of the VSI OpenVMS operating system.

```
IADDRESS( x )
```

The parameter *x* can be of any type except a component of a packed structured type.

Note

The VSI Pascal compiler automatically assumes that all pointers refer either to dynamic variables allocated by the NEW procedure or to variables that have the VOLATILE attribute. You, therefore, should use utmost caution when using the IADDRESS function. This function does not generate compile-time warnings about volatility.

Consider the following example:

```
VAR
  Real_Addr : INTEGER_ADDRESS;
  Real_Var  : [VOLATILE] REAL;
{In the executable section:}
Real_Addr := IADDRESS( Real_Var ); {Returns address of Real_Var}
WRITELN( 'The address of Real_Var is', Real_Addr );
```

For More Information:

- On the VOLATILE attribute (Section 10.2.42)
- On the ADDRESS function (Section 8.4)
- On the NEW procedure (Section 8.58)

8.43. IADDRESS64 Function

The IADDRESS64 function returns an INTEGER64 value that refers to the address of either a constant or VOLATILE variable, or parameter, or a routine. The IADDRESS64 function is otherwise identical to the IADDRESS function.

```
IADDRESS64 ( x )
```

The parameter *x* can be of any type except a component of a packed structured type.

For More Information:

- On the IADDRESS function (Section 8.42)

8.44. IN_RANGE Function

The IN_RANGE function determines if a value is in the defined subrange.

```
IN_RANGE ( expression, lower-expression, upper-expression )
```

The parameters must be expressions of the same ordinal type. The function returns TRUE if *x* has a value that is in the range specified by *lower-expression* and *upper-expression*; otherwise, the function returns FALSE.

8.45. INDEX Function

The INDEX function searches a string for a specified substring and returns an integer value that either indicates the location of the substring or the status of the search.

```
INDEX ( string, substring )
```

INDEX requires two character-string expressions as parameters: a string to be searched and a substring to be found.

The search ends as soon as the first occurrence of the substring is located:

- If the substring is found, INDEX returns the string component that contains the first letter of the substring.
- If the substring is not found, INDEX returns the value 0.
- If the substring is an empty string, INDEX returns the value 1.
- If the string to be searched is an empty string, INDEX returns the value 0 unless the substring is also empty, in which case, INDEX returns the value 1.

- If the substring is found, it does not return the string component but the index (such as subscript) of the component.

Consider the following example:

```
The_String := 'The Pilgrims landed at Plymouth Rock';
Substring  := 'Plymouth Rock';
Position   := INDEX( The_String, Substring ); {Returns 24}
Substring  := 'Mayflower';
Position   := INDEX( The_String, Substring ); {Returns 0}
```

For More Information:

- On character strings (Section 2.6)

8.46. INT Function

The INT function converts the parameter and returns its INTEGER equivalent.

```
INT ( x )
```

The parameter *x* must be of an ordinal type.

Overflow can occur and is detected at runtime if overflow checking is enabled and the value of *x* is outside the range of INTEGER.

8.47. INT64 Function

The INT64 function converts the parameter and returns its INTEGER64 equivalent.

```
INT64 ( x )
```

The parameter *x* must be of an ordinal type.

Overflow can occur and is detected at run time if overflow checking is enabled and the value of *x* is outside the range of INTEGER64.

8.48. LE Function

The LE function returns a Boolean value that specifies if the first parameter is less than or equal to the second parameter, according to the ASCII values of the strings' characters.

```
LE( str1, str2 )
```

The parameters *str1* and *str2* must be character-string expressions. VSI Pascal does not pad shorter strings with blanks.

The expression `LE(Str1, Str2)` is equivalent to the following:

```
( LENGTH( Str1 ) < LENGTH( Str2 ) ) OR ( Str1 <= Str2 )
```

Consider the following example:

```
VAR
```

```
Match : BOOLEAN;
Test  : STRING( 8 ) VALUE 'ENTRANCE';
{In the executable section:}
Match := LE( 'exit', 'exit' );    {Returns TRUE}
Match := LE( Test, 'EXIT' );     {'N' less-than 'X': Returns TRUE}
```

For More Information:

- On string data types (Section 2.6)

8.49. LENGTH Function

The LENGTH function returns an integer value that is the length of a specified string expression.

```
LENGTH( str )
```

The str parameter must be a character-string expression.

For More Information:

- On character strings (Section 2.6)

8.50. LN Function

The LN function returns a real value that represents the natural logarithm of the specified parameter.

```
LN( x )
```

The parameter x can be an integer or REAL type. The value of x must be greater than zero.

8.51. LOWER Function

The LOWER function returns the lower bound for ordinal types, SET base types, and array indexes.

```
LOWER( x [[, n]] )
```

The parameter x is a type identifier or variable of an ordinal, SET, or ARRAY type. The parameter n is an integer constant that denotes a dimension of x, if x is an array. If x is an array and if you omit the parameter n, VSI Pascal uses the default value 1. If x is an array, LOWER returns the lower bound of the nth dimension of x. If x is an ordinal type, LOWER returns the lower bound or smallest value. If x is a SET, LOWER returns the lower bound of the SET base type.

For More Information:

- On the LOWER function (Section 8.100)

8.52. LSHIFT Function

The LSHIFT predeclared function returns a value of the same type as its first parameter. The return value represents the value of the first parameter after the bits have been shifted to the left.

```
LSHIFT (expression, expression) )
```

The parameters are two integer or unsigned values. The first parameter represents a value to shift; the second represents the number of bits to shift the first value to the left. LSHIFT inserts zero bits on the right as the bits shift left.

Note that shifting integers is not equivalent to multiplying or dividing by a power of two when the value of the integer is negative.

If the number of bits shifted is larger than the natural integer size of the target platform, the result is undefined.

For More Information:

- On the RSHIFT function (Section 8.77)

8.53. LT Function

The LT function returns a Boolean value that specifies if the first parameter is less than the second parameter, according to the ASCII values of the strings' characters.

```
LT( str1, str2 )
```

The parameters `str1` and `str2` must be character-string expressions. VSI Pascal does not pad shorter strings with blanks. Consider the following example:

```
VAR
    Match : BOOLEAN;
    Test   : STRING( 8 ) VALUE 'ENTRANCE';
{In the executable section:}
Match := LT( 'exit', 'exit' );    {Returns FALSE}
Match := LT( Test, 'EXIT' );     {'N' less than 'X': Returns TRUE}
```

For More Information:

- On string data types (Section 2.6)

8.54. MALLOC_C_STR Function

The MALLOC_C_STR function takes a Pascal string expression, calls the C routine `malloc()` to allocate memory, initializes the memory with the string expression, and then terminates the string with a null-character.

```
MALLOC_C_STR(e)
```

The type of the expression `e` must be a Pascal string expression. The function result is a `C_STR_T` pointer to the null-terminated string. The amount of memory allocated with `malloc()` is equal to the length of the string expression plus one. The memory allocated with MALLOC_C_STR must be deallocated with the `free()` routine. The compiler will not allow `C_STR_T` parameters with the NEW and DISPOSE routines.

8.55. MAX Function

The MAX function returns a value (the same type as that of the parameters) that is the maximum value of a specified list of parameters.

```
MAX( x1, ..., xn )
```

The parameters can be any arithmetic type, but they must all be of the same type.

8.56. MIN Function

The MIN function returns a value (of the same type as that of the parameters) that is the minimum value of a specified list of parameters.

```
MIN( x1, ..., xn )
```

The parameters can be any arithmetic type, but must all be of the same type.

8.57. NE Function

The NE function returns a Boolean value that specifies if the parameters are not equal according to the ASCII values of the strings' characters.

```
NE( str1, str2 )
```

The parameters str1 and str2 must be character-string expressions. VSI Pascal does not pad shorter strings with blanks. Consider the following example:

```
VAR
    Match : BOOLEAN;
{In the executable section:}
Match := NE( 'exit  ', 'exit' );   {Returns TRUE}
Match := NE( 'exit', 'exit' );    {Returns FALSE}
```

For More Information:

- On string data types (Section 2.6)

8.58. NEW Procedure

The NEW procedure allocates memory for the dynamic variable to which a pointer variable refers. The value of the newly allocated variable is set to the initial value of the base type if defined; otherwise, the value of the variable is undefined.

```
NEW( p [[, {t1, ..., tn }
      {d1, ..., dn } ]]
```

The parameter p is a pointer variable. On VSI OpenVMS I64 and VSI OpenVMS Alpha systems, if the pointer type was declared with the [QUAD] attribute, the NEW procedure allocates memory from the 64-bit process address space (p2 space).

The parameters t1,...,tn are constant expressions of an ordinal type that represent nested tag-field values, where t1 is the outermost variant.

If the object of the pointer is a non schema record type with variants, then you have two ways of allocating memory. If you do not specify *t* parameters, VSI Pascal allocates enough memory to hold any of the variants of the record. If you do specify *t* parameters, then VSI Pascal allocates enough memory to hold only the variant or variants that you specify.

Since the *t* parameters cause VSI Pascal to allocate memory for the variant alone and not for the whole record, you cannot assign or evaluate the record as a whole; you can assign and evaluate only the individual fields. Also, a call to `NEW` sets the tag fields of a variant record.

The parameters *d*₁,...,*d*_{*n*} are compile-time or run-time ordinal values that must be the same type as the formal discriminants of the object.

If the object of the pointer is of an undiscriminated schema type, you must specify a *d* parameter for each of the formal discriminants of the schema type. The *d* parameters discriminate the schema type in much the same way as actual discriminants in a discriminated schema. The size of the allocation is based on the value of the *d* parameters.

If the object is a schema record type, then you must use *d* parameters; you cannot use *t* parameters or a combination of the syntaxes. If the schema record type contains a variant (which depends on one of the formal discriminants) then the *d* parameter discriminates the schema, determines the variant, and allows VSI Pascal to compute the necessary size of the allocation.

Note

If you specify *t* parameters to the `NEW` procedure, you must specify the same *t* parameters to the `DISPOSE` procedure that deallocates memory for the corresponding variable.

Consider the following examples:

```

TYPE
  Meat_Type = ( Fish, Fowl, Beef );
  Beef_Portion = ( Oz_10, Oz_16, Oz_32 );
  Var_Record = RECORD
    CASE Entree : Meat_Type OF
      Fish : ( Fish_Type : ( Salmon, Cod, Perch, Trout );
              Lemon : BOOLEAN );
      Fowl : ( Fowl_Type : ( Chicken, Duck, Goose );
              Sauce : ( Orange, Cherry, Raisin ));
      Beef : ( Beef_Type : ( Steak, Roast, Prime_Rib );
              CASE size : Beef_Portion OF
                Oz_10, Oz_16 : ( Beef_Veg : ( Pea, Mixed ));
                Oz_32       : ( Stomach_Cure :
                               ( Bicarb, Antacid, None ));
              END;
    The_Schema( Upper_Bound : INTEGER )
      = ARRAY [1..Upper_Bound] OF INTEGER;
VAR
  To_Int      : ^INTEGER;
  To_Var_Record : ^Var_Record;
  To_Schema   : ^The_Schema;
  Bound       : INTEGER VALUE 32;

{In the executable section:}
NEW( To_Int ); {Memory for To_Int^ allocated but not initialized}

NEW( To_Var_Record, Fish ); {Memory allocated only for Fish variant}

```

```
DISPOSE( To_Var_Record, Fish ); {Specify Fish to DISPOSE}
NEW( To_Var_Record, Beef, Oz_32 ); {Allocates more memory this time}
DISPOSE(To_Var_Record, Beef, Oz_32 );

NEW( To_Schema, Bound ); {Allocation for undisc. schema object}
DISPOSE( To_Schema );
```

For More Information:

- On variant records (Section 2.4.2.1)
- On schema types (Section 2.5)
- On the DISPOSE procedure (Section 8.28)

8.59. NEXT Function

The NEXT function returns an integer value that indicates the number of bytes that would be allocated for one component of the specified type in an unpacked array, or if the specified variable appeared as the cell in an unpacked array.

```
NEXT ( x )
```

The parameter *x* can be a type identifier or variable.

Cells in an unpacked array are affected by alignment attributes and, by default, are byte aligned. Therefore, the size returned includes the actual size of the type or variable, in addition to trailing space required to ensure proper alignment.

If a variable that is not allocated to an integral number of bytes is passed to NEXT, the number of bits are rounded down to the nearest byte and then the number of bytes are returned.

For More Information:

- On examples of return values for this function (Section 8.81)
- On arrays (Section 2.4.1)

8.60. OCT Function

The OCT function returns a character-string value that is the octal equivalent of the specified parameter. The return value is compatible with all other string types.

```
OCT( x[[, length[[, digits]] ]] )
```

The parameter *x* is the expression to be converted. This parameter must have a size that is known at compile time; it cannot be VARYING OF CHAR, a conformant parameter, or a schema type.

Two optional integer parameters specify the length of the resulting string and the minimum number of significant digits to be returned. If you specify a length that is too short to hold the converted value, the resulting string is truncated on the left. By default, the number of significant digits is the minimum number of characters necessary to express all the bits of the converted parameter. This default length is one character more than the default number of digits, which causes a leading blank to be included in the resulting string when both parameters are omitted. Consider the following example:

```
Int_Var := 427;  
Result := OCT( Int_Var, 10, 3 ); {Returns ' 653'}
```

For More Information:

- On character strings (Section 2.6)

8.61. ODD Function

The ODD function returns a Boolean value that indicates if the parameter is odd.

```
ODD ( x )
```

The parameter *x* must be integer or unsigned. This function returns TRUE if the value of *x* is odd and FALSE if the value of *x* is even.

8.62. OR_ATOMIC Function (OpenVMS I64 and OpenVMS Alpha systems only)

The OR_ATOMIC function logically ORs the value of an expression to the value of a variable, stores the newly computed value in the variable, and returns the previous value of the variable.

```
OR_ATOMIC ( e, v )
```

The type of the expression *e* must be assignment compatible with that of the variable *v*. The variable *v* must be an INTEGER, UNSIGNED, INTEGER64, or UNSIGNED64 variable and must be allocated on a natural boundary (such as, longword for INTEGER and UNSIGNED and quadword for INTEGER64 and UNSIGNED64). The result of OR_ATOMIC is the same type as the variable *v*.

The OR_ATOMIC function does not provide memory synchronization between multiple processors. The BARRIER predeclared routine must be used for that purpose.

This function is used to access data that is shared between two or more threads of execution.

For More Information

- On atomic operations (*VSI Pascal for OpenVMS User Manual*)

8.63. ORD Function

The ORD function returns an integer value that is the position of the parameter in the ordered sequence of values of the parameter's type.

```
ORD ( x )
```

The parameter *x* must be of an ordinal type. Note that the ordinal value of an INTEGER object is the integer itself. If *x* is of type UNSIGNED, its value must not be greater than MAXINT.

8.64. PACK Procedure

The PACK procedure copies components of an unpacked array variable to a packed array variable.

```
PACK( a, i, z )
```

The parameter *a* is an unpacked array. The parameter *i* is a value to indicate the starting value of the index of *a*. The parameter *z* is a packed array of the same component type as *a*.

The number of components in parameter *a* must be greater than or equal to the number of components in *z*. This procedure assigns the components of *a*, starting with *a*[*i*], to the array *z*, starting with *z*[low-bound], until all the components in *z* are filled.

In general, when specifying *i*, keep in mind that the upper bound of *a* (that is, *n*) must be greater than or equal to $i + v - u$, where *v* is the upper bound of *z* and *u* is the lower bound of *z*. That is, `ORD (n)` must be greater than or equal to `ORD (i) + ORD (v) - ORD (u)`. Consider the following example:

```
VAR
  a : ARRAY[1..25] OF 0..15;
  p : PACKED ARRAY[1..20] OF 0..15;
  i : INTEGER;
{In the executable section:}
FOR i := 1 TO 20 DO
  READ ( a[i] );
PACK( a, 5, p ); {a[1] through a[4] are not used}
PACK( a, 1, p ); {a[21] through a[25] are not used}
```

For More Information:

- On arrays and packed arrays (Section 2.4)

8.65. PAD Function

The `PAD` function returns a character-string value, of the specified size, that contains padded fill characters. The return value is compatible with all other string types.

```
PAD( str, fill, size )
```

The parameter *str* is a character-string value to be padded; the parameter *fill* is a value of type `CHAR` to be used as the fill character; and the parameter *size* is an integer value indicating the size of the final string.

This string is composed of the original string followed by the fill character, which is repeated as many times as is necessary to extend the string to its specified size. The final size must be greater than or equal to the length of the string to be padded.

For More Information:

- On character strings (Section 2.6)

8.66. PAS_STR Function

The `PAS_STR` function returns a Pascal string value from a `C_STR_T` value.

```
PAS_STR(e)
```

The type of the expression *e* must be `C_STR_T`. It is an error if the expression is `NIL`.

8.67. PAS_STRCPY Function

The PAS_STRCPY function copies a Pascal string expression into memory pointed to by C_STR_T.

```
PAS_STRCPY (v, e)
```

The type of the variable *v* must be C_STR_T. The type of the expression *e* must be a Pascal string expression. The Pascal string is copied into the memory pointed to by the variable *v*. The memory is then terminated with a null character. The function returns a C_STR_T value representing the destination (such as, the same value as contained by the variable *v*).

The behavior of PAS_STRCPY is undefined if the length of the Pascal string expression is greater than or equal to the amount of memory pointed to by the variable *v*. It is an error if the variable *v* is NIL.

8.68. PRED Function

The PRED function returns the value preceding the parameter according to the parameter's data type.

```
PRED ( x )
```

The parameter *x* can be of any ordinal type; however, there must be a predecessor value for *x* in the type.

8.69. PRESENT Function

The PRESENT function returns a Boolean value that indicates whether the actual argument list of a routine contains an argument that corresponds to a formal parameter. (This function is usually used to supply a default value or to take a default action when the argument for a parameter is omitted.)

```
PRESENT ( parameter-name )
```

The parameter-name parameter is the name of a formal parameter with the TRUNCATE attribute. The parameter-name must be the name of a formal parameter of the function from which PRESENT is called, or from a subroutine of that function. The function result indicates whether the argument list of the containing routine specifies an actual argument corresponding to an optional parameter.

Parameters that do not have the TRUNCATE attribute, and also do not follow a parameter with the TRUNCATE attribute in the formal parameter list, are allowed; in their case, the PRESENT function always returns TRUE.

Default parameters are considered to be present in the argument list, and the PRESENT function returns TRUE when passed the name of a parameter with a default value.

For More Information:

- On examples using PRESENT and TRUNCATE (Section 10.2.37)
- On parameters (Section 6.3)

8.70. QUAD Function

The QUAD function converts the parameter and returns its QUADRUPLE equivalent.

```
QUAD ( x )
```

The parameter `x` must be an arithmetic type.

For More Information:

- On precision and support for the QUADRUPLE data type (Chapter 2)

8.71. RANDOM Function

The RANDOM function returns a randomly computed real value in the range [0.0,1.0) based on a seed that is initially set to the value 7774755. The seed used by the RANDOM function can be modified with the SEED function.

```
RANDOM[[ ( expression )]]
```

If present, the optional expression parameter is ignored.

For More Information:

- On the SEED function (Section 8.78)

8.72. READV Procedure

The READV procedure reads characters from a character-string expression and assigns them to parameters in the READV call. The behavior of READV is similar to that of READLN; the character string is similar to a one-line file.

```
READV( str, {variable-identifier[[ : radix-specifier ]]},... [[, ERROR :=  
error-recovery ]] )
```

`str`

The `str` parameter is the string to be read.

`variable_identifier`

The `variable-identifier` is the name of the variable to be assigned a value from `str`.

`radix-specifier`

The `radix-specifier` parameter is one of the format values BIN, OCT, or HEX. These values, when used on a `variable-identifier`, read the variable in binary, octal, or hexadecimal, respectively. You can read a variable of any type by using a `radix-specifier` except a type that contains a file component.

`error-recovery`

The `error-recovery` parameter is the action to be taken if an error occurs during execution of the routine.

An error occurs at run time if values have not been assigned to all the parameters listed in the READV procedure call before the end of the character string is reached, as shown in this example:

```
TYPE  
  Color = ( Yellow, Red, Blue );  
VAR  
  Paint, Paint2 : Color;
```

```
Month : VARYING[5] OF CHAR;
Real_Var : REAL;
Read_String : VARYING[17] OF CHAR;

{In the executable section:}
Read_String := 'Red July 26.33805';

READV( Read_String, Paint, Month, Real_Var );
{Paint contains Red, Month contains 'July', and Real_Var contains 26.33805}

READV( Read_String, Paint, Month, Real_Var, Paint2 );
{Error: end of string reached after assigning to Real_Var}

READV( Read_String, Paint, Month ); {Legal: '26.33805' is not used}
READV( Read_String, Real_Var, Paint, Month ); {Error: Red is not REAL}
```

For More Information:

- On input and output (Chapter 9)
- On character strings (Section 2.6)
- On error recovery codes (*VSI Pascal for OpenVMS User Manual*)

8.73. RENAME_FILE Procedure

The RENAME_FILE procedure renames a file.

```
RENAME_FILE( old-file-name, new-file-name [[, error-return]] )
```

The parameter old-file-name specifies the names of one or more files whose specifications are to be changed. The new-file-name parameter provides the new file specification to be applied. The error-return parameter contains an error recovery code if specified.

For More Information:

- On error processing (*VSI Pascal for OpenVMS User Manual*)

8.74. REVERT Procedure

The REVERT procedure cancels a condition handler activated by the ESTABLISH procedure. This procedure does not have a parameter list.

For More Information:

- On error processing (*VSI Pascal for OpenVMS User Manual*)

8.75. ROUND Function

The ROUND function converts the value of the parameter by rounding the fractional part of the value, and returns its integer equivalent.

```
ROUND ( x )
```

The parameter *x* must be of type REAL, SINGLE, DOUBLE, or QUADRUPLE. The value of *x* must not be too large to be represented by an integer.

8.76. ROUND64 Function

The ROUND64 function converts the value of the parameter by rounding the fractional part of the value, and returns its INTEGER64 equivalent.

```
ROUND64 ( x )
```

The parameter *x* must be of type REAL, SINGLE, DOUBLE, or QUADRUPLE. The value of *x* must not be too large to be represented by an INTEGER64.

8.77. RSHIFT Function

The RSHIFT predeclared function returns a value of the same type as its first parameter. The value represents the value of the first parameter after the bits have been shifted to the right.

```
RSHIFT(expression, expression)
```

The expression parameters are two integer or unsigned values. The first parameter represents a value to shift; the second represents the number of bits to shift the first value. The RSHIFT function inserts zero bits on the left as the bits shift right.

Note that shifting integers is not equivalent to multiplying or dividing by a power of two when the value of the integer is negative.

If the number of bits shifted is larger than the natural integer size of the target platform, the result is undefined.

For More Information:

- On the LSHIFT function (Section 8.52)

8.78. SEED Function

The SEED function has a single integer parameter that sets the random number generator seed for the RANDOM function. The function returns an integer that represents the previous seed value.

```
SEED(expression)
```

The expression parameter is an integer.

For More Information:

- On the RANDOM function (Section 8.71)

8.79. SET_INTERLOCKED Function

The SET_INTERLOCKED function assigns the value TRUE to the parameter and returns its original Boolean value.

```
SET_INTERLOCKED ( b )
```

The parameter `b` must be a variable of type `BOOLEAN`. The variable does not have to be aligned; therefore, it can be a field of a packed record.

8.80. SIN Function

The `SIN` function returns a real value that represents the sine of the specified parameter.

```
SIN ( x )
```

The parameter `x` can be an integer or `REAL` type, and is expressed in radians.

8.81. SIZE Function

The `SIZE` function returns an integer value that indicates the possible or actual number of bytes that are allocated for a specified data type or variable.

```
SIZE ( x [ [, t1, . . . , tn ] ] )
```

The parameter `x` can be a type identifier or variable. If `x` is a type identifier, then the functions return an integer value that indicates the number of bytes that would be allocated for a variable or record field of type `x`. If `x` is a variable, then the functions return an integer value that indicates the number of bytes that are allocated for that variable.

In the case where the parameter `x` is a variant record variable or variant type identifier, `SIZE` returns an integer value that indicates the number of bytes that are allocated (for a variant record variable) or would be allocated (for a variant type identifier) for both the fixed portion of the record and the largest variant. In addition, you can supply additional parameters `t1` through `tn` that correspond to the case labels of the record. The function returns an integer value that indicates the number of bytes that would be allocated by the `NEW` procedure for a dynamic variable of the specified variant.

If a variable that is not allocated to an integral number of bytes is passed to `SIZE`, the number of bits will be rounded up to the nearest byte and then the number of bytes will be returned.

Table 8.2 presents values returned by the alignment routines if the routines accepted objects of the specified data types.

Table 8.2. Return Values of Alignment Predeclared Routines

Type or Variable	Size in Bits		Size in Bytes	
	BITNEXT	BITSIZE	NEXT	SIZE
[BIT (1)] BOOLEAN	1 ¹	1	1 ²	1 ³
0..25 (subrange)	5 ¹	5	4 ⁴	4 ⁴
[BYTE] 0..255 (byte)	8	8	1	1
[BYTE, ALIGNED (2)] 0..225	32 ⁵	8	4 ⁵	1
First element of: PACKED ARRAY [1..10] OF 0..25	5	5	0 ⁶	1 ³
PACKED ARRAY [1..10] OF 0..25	56 ⁷	56 ⁷	7	7

¹By default, the variable is unaligned in a packed context.

²By default, the variable is byte aligned in an unpacked context.

³`SIZE` rounds up to the nearest byte for the bit-sized objects.

⁴Subranges assume the size of their base types in an unpacked context.

⁵Extra space is needed to fulfill alignment requirements.

⁶NEXT rounds down to the nearest byte for bit-sized objects.

⁷Items larger than 32 bits must be allocated in an integral number of bytes.

For More Information:

- On storage allocation and alignment for data types (Appendix A)

8.82. SNGL Function

The SNGL function converts the parameter and returns its real equivalent.

SNGL (x)

The parameter x must be an arithmetic type. The value of x must not be too large to be represented by a single-precision number.

8.83. SQR Function

The SQR function returns a value (of the same type of the parameter) that represents the square of the specified parameter.

SQR (x)

The parameter x can be any arithmetic type.

8.84. SQRT Function

The SQRT function returns a real value that represents the square root of the specified parameter.

SQRT (x)

The parameter x can be an INTEGER, UNSIGNED, or REAL type. If the value of x is less than zero, an error occurs.

8.85. STATUSV Function

The STATUSV function returns an integer value that specifies the status of the last READV or WRITEV procedure completed. STATUSV does not have any parameters.

This example shows the use of the STATUSV function:

```
VAR
  Vary_Src   : VARYING [20] OF CHAR;
  Int_Result : INTEGER;
{In the executable section:}
Vary_Src := '255';
READV( Vary_Src, Int_Result, ERROR := CONTINUE );
IF STATUSV <> 0 THEN {0 means READV executed successfully}
  WRITELN( 'Error in READV' );
```

If, however, you have an asynchronous system trap (AST) routine condition handler in your program that uses READV and WRITEV, the call of STATUSV in your main program may not return the results you expected if an AST occurred between the READV/WRITEV procedure and the STATUSV procedure.

For More Information:

- On the READV procedure (Section 8.72)
- On the WRITEV procedure (Section 8.107)
- On character strings (Section 2.6)

8.86. SUBSTR Function

The SUBSTR function returns a substring (from a string specified as a parameter) that is of the specified starting point and length. The return value is compatible with all other string types.

```
SUBSTR( str, start, length )
```

The parameter `str` is a character-string value; the parameter `start` is an integer value indicating the starting position of the substring. The parameter `length` is an integer value that indicates the length of the substring.

The following rules apply to the use of the SUBSTR function:

- The value of the starting position must be greater than 0.
- The value of the length must be greater than or equal to 0.
- There must be enough characters following the starting position to construct a substring of the specified length.

Consider the following example:

```
Original_String := 'This is the original string';  
Start_Position := 13;  
Substring_Length := 15;  
New_String := SUBSTR( Original_String, Start_Position,  
                      Substring_Length );  
{New_String contains 'original string'}
```

For More Information:

- On character strings (Section 2.6)

8.87. SUCC Function

The SUCC function returns the value that succeeds the parameter according to the parameter's data type.

SUCC (x)

The parameter x can be of any ordinal type; however, there must be a successor value for x in the type.

8.88. SYSCLOCK Function

The SYSCLOCK function returns an integer value for the number of milliseconds of system time used by the current process. The result is the same as that returned by the CLOCK function.

SYSCLOCK

For More Information:

- On the WALLCLOCK function (Section 8.106)
- On the CLOCK function (Section 8.20)

8.89. TIME Procedure

See Section 8.24.

8.90. TRUNC Function

The TRUNC function converts the value of the parameter by truncating the fractional part of the value and returns its integer equivalent.

TRUNC (x)

The parameter x must be of type REAL, SINGLE, DOUBLE, or QUADRUPLE. The value of x must not be too large to be represented by an integer.

8.91. TRUNC64 Function

The TRUNC64 function converts the value of the parameter by truncating the fractional part of the value and returns its INTEGER64 equivalent.

TRUNC64 (x)

The parameter x must be of type REAL, SINGLE, DOUBLE, or QUADRUPLE. The value of x must not be too large to be represented by an INTEGER64.

8.92. UAND Function

The UAND function returns an unsigned value that represents a binary logical AND operation on each corresponding pair of bits of the specified parameters.

```
UAND ( u1, u2 )
```

The parameters `u1` and `u2` must be of type `UNSIGNED`. Consider the following example:

```
Result := UAND( 16#FF9, 16#703 ); {Returns 1793, which is 16#701}
```

For More Information:

- On specifying extended-digit notation (Section 2.1.1.1)

8.93. UDEC Function

The `UDEC` function returns a character-string value that is the unsigned decimal equivalent of the specified parameter. The return value is compatible with all other string types.

```
UDEC ( x[[, length[[, digits]] ] ] )
```

The parameter `x` is the expression to be converted. The `UDEC` function can take a parameter of any type except `VARYING` of `CHAR`, conformant parameters, or schema types. This function requires the size of the parameter `x` to be less than or equal to the size of `INTEGER64` (if supported) on your system. If your system does not support `INTEGER64`, then the `UDEC` function requires that the parameter `x` be less than or equal to the size of `INTEGER32`.

Two optional integer parameters specify the length of the resulting string and the minimum number of significant digits to be returned. If you specify a length that is too short to hold the converted value, the resulting string is truncated on the left.

If you do not specify values for the optional parameters, a default length and a default minimum number of significant digits is used. If the size of the parameter `x` is greater than 32, the defaults are 21 characters for the length and 20 characters for the minimum number of digits. Otherwise, the defaults are 11 characters for the length and 10 characters for the minimum number of digits.

Consider the following example:

```
VAR
    Account : INTEGER;
{In the executable section:}
Account := 3;
WRITELN( UDEC( Account ) );
```

For More Information:

- On conformant parameters (Section 6.3.7)
- On `VARYING OF CHAR` (Section 2.6.2)

8.94. UINT Function

The `UINT` function converts the value of the parameter and returns its unsigned equivalent.

```
UINT ( x )
```

The parameter `x` must be of an ordinal type.

No error results if x is an integer and has a negative value. The value returned is $x \text{ MOD } 2^{**}32$.

For More Information:

- On range and support for the UNSIGNED data type (Chapter 2)

8.95. UINT64 Function

The UINT64 function converts the value of the parameter and returns its UNSIGNED64 equivalent.

`UINT64 (x)`

The parameter x must be of an ordinal type.

No error results if x is an integer and has a negative value. The value returned is $x \text{ MOD } 2^{**}64$.

For More Information:

- On the UNSIGNED64 data type (Chapter 2)

8.96. UNDEFINED Function

The UNDEFINED function returns a Boolean value that specifies whether the parameter contains an undefined (invalid) operand.

`UNDEFINED (x)`

The parameter x must be a variable of type REAL, SINGLE, DOUBLE, or QUADRUPLE.

On VSI OpenVMS I64 and VSI OpenVMS Alpha systems, the UNDEFINED routine returns FALSE if the floating-point value is finite and returns TRUE if the value is not finite.

A finite number is a floating-point value with a definite, in-range value. Specifically, all numbers in the inclusive ranges $-MAX$ through $-MIN$, zero, and $+MIN$ through $+MAX$, where MAX is the largest non-infinite representable floating-point number for the variable's type and MIN is the smallest non-zero representable normalized floating-point number for the variable's type. These correspond to the MINREAL, MAXREAL, MINDOUBLE, MAXDOUBLE, MINQUADRUPLE, and MAXQUADRUPLE predeclared constants.

For F_Float, D_Float, and G_Float, finites do not include reserved operands and dirty zeros (this differs from the VAX interpretation of dirty zeros as finite). For S_Float, T_Float, and X_Float, finites do not include infinities, NaNs, or denormals, but do include minus zero.

8.97. UNOT Function

The UNOT function returns an unsigned value that represents a binary logical NOT operation on each bit of the specified parameter.

`UNOT (u)`

The u parameter must be an unsigned expression. Consider the following example:

```
Result := UNOT( 16#FF9 ); {Returns 16#FFFFFF06}
```

For More Information:

- On specifying extended-digit notation (Section 2.1.1.1)

8.98. UNPACK Procedure

The UNPACK procedure copies components of a packed array to an unpacked array variable.

```
UNPACK( z, a, i )
```

The parameter *z* is a packed array. The parameter *a* is an unpacked array variable. The parameter *i* is the starting value of the index of *a*.

The number of components in parameter *a* must be greater than or equal to the number of components in *z*. The UNPACK procedure assigns the components of *z*, starting with *z*[low-bound], to the array *a*, starting with *a*[*i*], until all the components in *z* are used.

In general, when specifying *i*, keep in mind that the upper bound of *a* (that is, *n*) must be greater than or equal to $i + v - u$, where *v* is the upper bound of *z* and *u* is the lower bound of *z*. That is, ORD (*n*) must be greater than or equal to ORD (*i*) + ORD (*v*) – ORD (*u*).

Normally, you cannot pass the individual components of a packed array to formal VAR parameters; you must unpack the array first. Consider the following example:

```
VAR
  p : PACKED ARRAY[1..10] OF CHAR;
  a : ARRAY[1..10] OF CHAR;
  i : INTEGER;
PROCEDURE Process_Components( VAR Ch : CHAR ); {Body...}

{In the executable section:}
READ( p );
UNPACK( p, a, 1);
FOR i := 1 TO 10 DO
  Process_Components( a[i] ); {Pass each component to procedure}
```

For More Information:

- On arrays and packed arrays (Section 2.4.1)

8.99. UOR Function

The UOR function returns an unsigned value of a binary logical OR operation on the corresponding pair of bits of two specified parameters.

```
UOR( u1, u2 )
```

The *u1* and *u2* parameters must be unsigned. Consider the following example:

```
Result := UOR( 16#FF9, 16#703 ); {Returns 16#FFB}
```

For More Information:

- On specifying extended-digit notation (Section 2.1.1.1)

8.100. UPPER Function

The UPPER function returns the upper bound for ordinal types, SET base types, and array indexes.

```
UPPER( x [[, n]] )
```

The parameter *x* is a type identifier or variable of an ordinal, SET, or ARRAY type. The parameter *n* is an integer constant that denotes a dimension of *x*, if *x* is an array. If *x* is an array and if you omit the parameter *n*, VSI Pascal uses the default value 1. If *x* is an array, UPPER returns the upper bound of the *n*th dimension of *x*. If *x* is an ordinal type, UPPER returns the upper bound or largest value. If *x* is a SET, UPPER returns the upper bound of the SET base type. Consider the following example:

```
TYPE
  A_Schema( a, b : INTEGER) = a..a+b;
VAR
  x : A_Schema( 5, 10 );
{In the executable section:}
WRITELN( UPPER( BOOLEAN ) );      {Writes TRUE}
WRITELN( LOWER( x ) );           {Writes 5}
WRITELN( UPPER( x ) );           {Writes 15}
```

8.101. UROUND Function

The UROUND function converts the value of the parameter by rounding the fractional part of the value and returns its unsigned equivalent.

```
UROUND ( x )
```

The parameter *x* must be of type REAL, SINGLE, DOUBLE, or QUADRUPLE.

No error results if the value of *x* is negative or greater than 4,294,967,295. In that case, the unsigned result is the rounded parameter value MOD 4,294,967,296.

For More Information:

- On range and support of the UNSIGNED data type (Chapter 2)

8.102. UROUND64 Function

The UROUND64 function converts the value of the parameter by rounding the fractional part of the value and returns its UNSIGNED64 equivalent.

```
UROUND64 ( x )
```

The parameter *x* must be of type REAL, SINGLE, DOUBLE, or QUADRUPLE.

No error results if the value of *x* is negative or greater than MAXUNSIGNED64. In that case, the UNSIGNED64 result is the rounded parameter value MOD MAXUNSIGNED64.

For More Information:

- On range and support of the UNSIGNED64 data type (Chapter 2)

8.103. UTRUNC Function

The UTRUNC function converts the value of the parameter by truncating the fractional part of the value and returns its unsigned equivalent.

```
UTRUNC ( x )
```

The parameter *x* must be of type REAL, SINGLE, DOUBLE, or QUADRUPLE.

No error results if the value of *x* is negative or greater than 4,294,967,295. In that case, the unsigned result is the truncated parameter value MOD 4,294,967,296.

For More Information:

- On range and support of the UNSIGNED data type (Chapter 2)

8.104. UTRUNC64 Function

The UTRUNC64 function converts the value of the parameter by truncating the fractional part of the value and returns its UNSIGNED64 equivalent.

```
UTRUNC64 ( x )
```

The parameter *x* must be of type REAL, SINGLE, DOUBLE, or QUADRUPLE.

No error results if the value of *x* is negative or greater than MAXUNSIGNED64. In that case, the unsigned result is the truncated parameter value MOD MAXUNSIGNED64.

For More Information:

- On range and support of the UNSIGNED64 data type (Chapter 2)

8.105. UXOR Function

The UXOR function returns an unsigned value of a binary logical exclusive-OR operation on the corresponding pair of bits of two specified parameters.

```
UXOR ( u1, u2 )
```

The *u1* and *u2* parameters must be unsigned.

```
Result := UXOR( 16#FF9, 16#703 ); {Returns 16#8FA}
```

For More Information:

- On specifying extended-digit notation (Section 2.1.1.1)

8.106. WALLCLOCK Function

The WALLCLOCK function returns an integer value representing the number of seconds since the boot time for the system.

WALLCLOCK

For More Information:

- On the SYSCLOCK function (Section 8.88)
- On the CLOCK function (Section 8.20)

8.107. WRITEV Procedure

The WRITEV procedure writes characters to a character-string variable of type VARYING OF CHAR or discriminated STRING, by converting the values of the parameters in the procedure call to textual representations. The behavior of WRITEV is similar to that of the WRITELN function; the character-string parameter is similar to a one-line file.

```
WRITEV( str, parameter-list [[, ERROR := error-recovery]] )
```

The str parameter is the string to be written to.

The parameter-list parameter is the variables to be assigned to str.

The error-recovery parameter is the action to be taken if an error occurs during execution of the routine.

The str parameter cannot appear within the parameter-list; if you attempt to do this, unexpected results may occur. An error occurs if WRITEV reaches the maximum length of the character string before the values of all the parameters in the procedure call have been written into the string. The error-recovery parameter indicates the action to be taken if an error occurs while the WRITEV procedure is executing. Consider the following example:

```
TYPE
  Flower = ( Daisy, Lily, Orchid, Tulip );
VAR
  Real_Var      : REAL VALUE 232.705;
  Write_String  : VARYING[21] OF CHAR;
  Bouquet       : Flower VALUE Orchid;
{In the executable section:}
WRITEV( Write_String, Daisy, Real_Var:7:3, PRED( Bouquet ) );
{Write_String contains ' DAISY232.705  LILY'}

WRITEV( Write_String, Daisy, Real_Var:7:3, PRED( Bouquet ),
        Bouquet );
{Error: there is no more room in the string parameter}
```

For More Information:

- On VARYING OF CHAR strings (Section 2.6.2)
- On formatting output (Section 9.6)
- On error recovery codes (*VSI Pascal for OpenVMS User Manual*)

8.108. XOR Function

The XOR function returns a value (of the same type as the parameters) of a binary logical exclusive-OR operation on two specified parameters.

```
XOR( p1, p2 )
```

The p1 and p2 parameters must be of the same type and must be of either the BOOLEAN or SET types.

```
Result := XOR( ['A', 'B', 'C'], ['B', 'C', 'D'] ); {Returns ['A', 'D']}
```

For More Information:

- On Boolean types (Section 2.1.3)
- On SET types (Section 2.4.3)

8.109. ZERO Function

The ZERO function returns data, whose type depends on the context of the function call, that sets any variable (except a file variable) to its binary zero.

```
ZERO
```

If you attempt to use the ZERO function to initialize a file variable, an error occurs. Do not specify a parameter list when you call the ZERO function.

Table 8.3 shows the value that ZERO assigns for each data type.

Table 8.3. Value of ZERO

Data Type	Value
All INTEGER types	0
All UNSIGNED types	0
CHAR	The character NUL
BOOLEAN	FALSE
Enumerated	The enumerated element with ORD(element) = 0
Subrange	0 ¹
REAL	0.0
DOUBLE	0.0
QUADRUPLE	0.0
ARRAY	ZERO applied to each component
RECORD	ZERO applied to each field
VARYING OF CHAR, STRING	The null string
SET	The empty set
Pointer	NIL

¹Note that an ordinal target with a subrange type can be initialized outside of the subrange. The compiler treats this as an error if used in a compile-time expression.

The `ZERO` function is used in two ways. You can use it as a compile-time expression to initialize a variable in the `TYPE`, `VAR`, `CONST`, or `VALUE` sections. You can also use it on the right side of an assignment statement that appears in the executable section where the target is either a variable, or, within the body of a function, the function identifier.

This example shows both uses:

```
TYPE
  Pre_Zeroed_Record = RECORD
    A: INTEGER;
    B: Array [1..3] of Real
  END VALUE ZERO;

VAR
  An_Array   : Array [1..10] of Real;
  Pre_Zeroed : Pre_Zeroed_Record;

BEGIN
  An_Array :=ZERO; {Initializes all of An_Array to zeroes}
  .
  .
  .
```

For More Information:

- On data initialization (Chapter 2)
- Using the `ZERO` function with records (Section 2.4.2.2)

Chapter 9. Input and Output Processing

The VSI Pascal I/O model provides an extensive set of predeclared routines. When programming with I/O, remember that the routines and their effects depend on the capabilities available in your environment; not all routines or organizations are available across environments.

This chapter discusses the following topics:

- Section 9.1: Files and File Organizations
- Section 9.2: Component Formats
- Section 9.3: Component Access Modes
- Section 9.4: File Locking
- Section 9.5: TEXT Files
- Section 9.6: Formatting Output
- Section 9.7: Error-Processing Parameter
- Section 9.8: I/O Routines

For More Information:

- On environment-specific I/O details (*VSI Pascal for OpenVMS User Manual* and Appendix C).

9.1. Files and File Organizations

A **file** is an organized collection of logically related data items. Data items within files are called **file components**. The **file organization** defines the physical arrangement of the components within the physical file, what types of access information are present in each component, and how components may be accessed by a program.

The VSI Pascal I/O model includes three file organizations: sequential, relative, and indexed.

To open a file, you can call the OPEN procedure. Also, you usually call one of the EXTEND, RESET, and REWRITE procedures to establish a starting position for reading from or writing to a file. (For relative and indexed file organizations, you can use procedures to locate a specific component to access.)

VSI Pascal makes distinctions between permanent external files and temporary internal files. An **external file** has a name in a directory and exists outside the context of an VSI Pascal program. An **internal file** has no name and is deleted after the program finishes execution.

A file declared in the program heading is external by default. A file declared in a nested block is internal by default. To change the default for internal files, call the OPEN procedure or specify a file name in the EXTEND, RESET, or REWRITE procedures.

The file is then considered external and is retained with the specified name after the program has finished execution. If you open an internal file with the `EXTEND`, `RESET`, or `REWRITE` procedure without a file name, the file remains an internal file.

Default Information:

If you do not specify a file organization at the time of file creation (using the `OPEN` procedure), VSI Pascal creates a file with sequential organization.

The following sections describe file organizations.

9.1.1. Sequential File Organization

Sequential file organization specifies that file components are stored one after the other, in the order in which they were entered into the file. VSI Pascal supports this organization for files on disk. This is the only organization supported for files on magnetic tape, on terminals, on card readers, and on line printers. Figure 9.1 shows this file organization.

Figure 9.1. Sequential File Organization

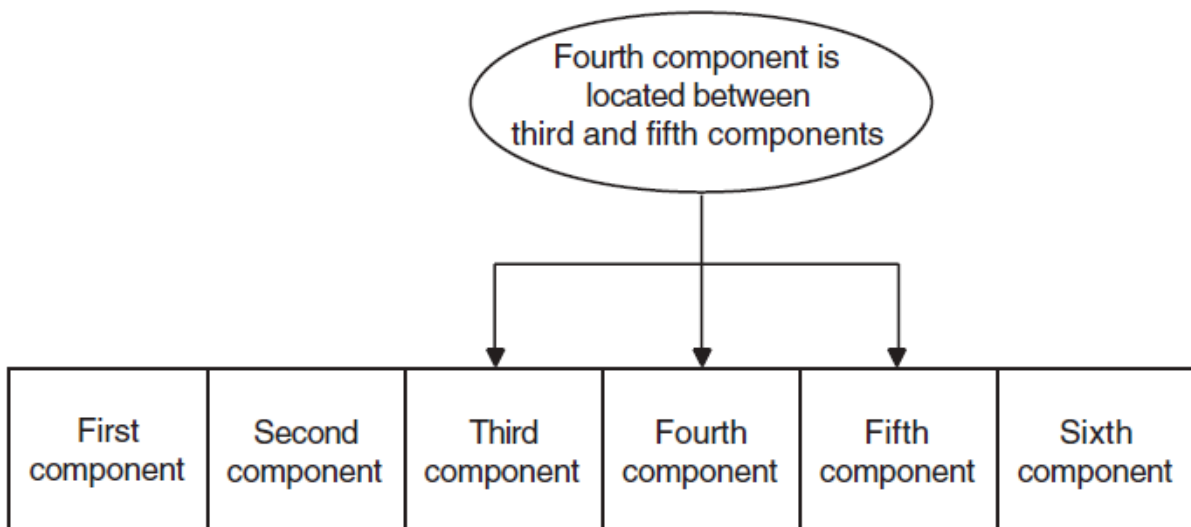

ZK-1332A-GE

You cannot insert components between any two existing components, because no physical space separates them. You can only add records to the end of the file (the most recently added component), truncate the file from a specified component to the end of the file, or rewrite the file.

For More Information:

- On component formats in sequential files (Section 9.2)
- On access methods for sequential files (Section 9.3)

9.1.2. Relative File Organization

Relative file organization consists of a series of fixed-length component positions (called **cells**) numbered consecutively from 1 to n. The numbered, fixed-length cells enable VSI Pascal to calculate the

component's physical position in the file. The cell numbers are called **relative component numbers**. VSI Pascal supports this organization on disk files only. Figure 9.2 shows this file organization.

Figure 9.2. Relative File Organization

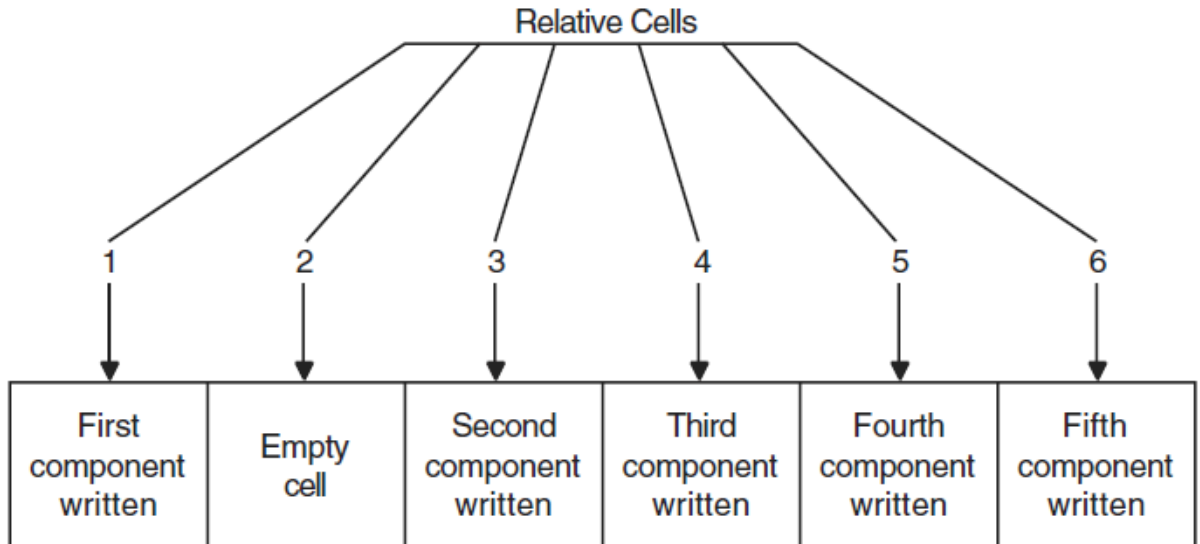

ZK-1333A-GE

Each component in the file may be randomly assigned to a specific cell. You can place components in unused cells and in cells from which components have been deleted. You cannot replace a component in a cell, but you can modify an existing component.

The length of the actual component may vary even though the cell containing the component is of a fixed length. If the component is smaller than the cell, the remaining space in the cell is unused.

For More Information:

- On component formats in relative files (Section 9.2)
- On access methods for relative files (Section 9.3)

9.1.3. Indexed File Organization

Indexed file organization specifies that, in addition to the stored components, there exists at least a primary key and possibly alternate keys (first alternate key, second alternate key, and so forth). VSI Pascal uses the primary key to store components and uses a program-specified key or keys to retrieve data. VSI Pascal supports this organization on disk files only.

To define a key and certain characteristics of keys, use the KEY attribute. You can define up to 254 alternate keys.

An **index** is a structure that provides a component collating sequence for the file, that is, a mechanism for accessing components in different orders depending on the specified index (name, address, telephone number, and so forth).

Figure 9.3 shows an indexed file organization that uses only a primary key.

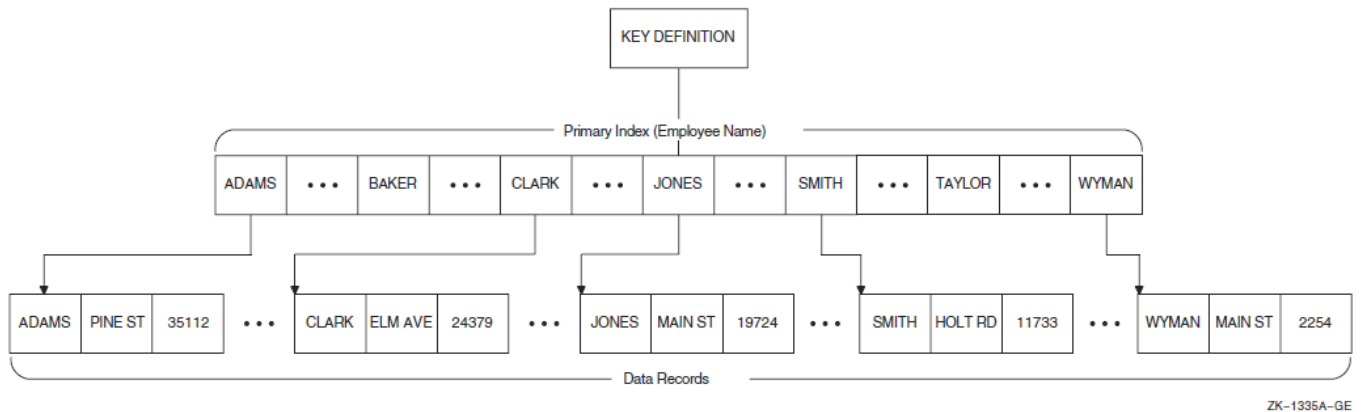
Figure 9.3. Indexed File Organization

In Figure 9.3 the components are logically stored in an order that is determined by the primary index. (The actual physical location of components is transparent to your program.) Figure 9.4 shows the presence of a first alternate index (determined by the presence of first alternate keys in the components) that points to components stored in order by the primary key.

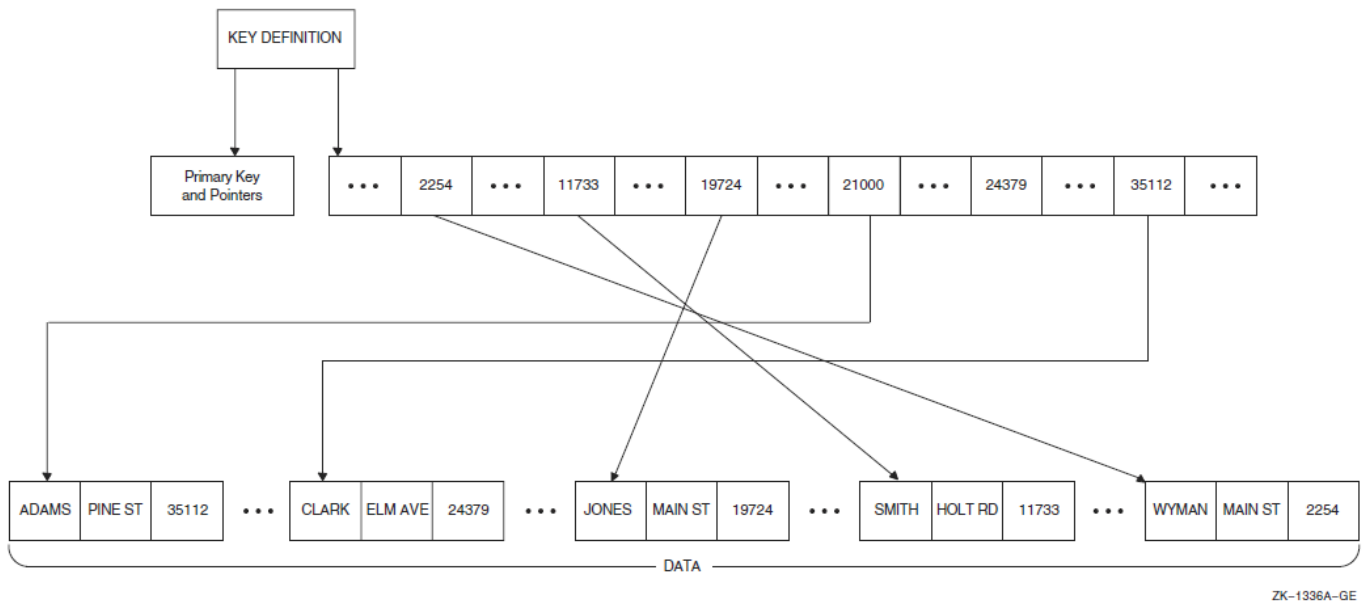
Figure 9.4. A First Alternate Key

For More Information:

- On component formats in indexed files (Section 9.2)
- On access methods for indexed files (Section 9.3)
- On the KEY attribute (Section 10.2.23)

In an indexed file, each component includes one or more **key fields** (or simply **keys**) that VSI Pascal uses to build the specified indexes. Each key is identified by its location within the component, its length, and its data type.

A key may be one of the following data types:

- A single, contiguous character string
- A 2- or 4-byte unsigned binary number
- A 1-, 2-, or 4-byte signed integer

You can use the **KEY** attribute to specify certain characteristics about the index and about the keys themselves. Table 9.1 describes these characteristics.

Table 9.1. Characteristics of the KEY Attribute

Keys	Description
Sort order	This characteristic determines how VSI Pascal creates an index, and determines the order in which VSI Pascal accesses components. The order can either be ascending or descending. If you specify ascending order, VSI Pascal considers the component with an equal or greater key value to be the next component for access. If you specify descending order, VSI Pascal considers the component with an equal or lesser key value to be the next component for access. Using different indexes and both ascending or descending order, you can use different collating sequences for a file's components according to the needs of your application.
Duplicate keys	This characteristic permits you to use the key value in more than one component. However, only the first component having the key value can be accessed randomly; other components having the same key value can only be accessed sequentially.
Changeable keys	This characteristic applies to alternate keys only. When you specify changeable keys, you can change the alternate keys in a component when you update the component. When an alternate key value changes, VSI Pascal automatically adjusts the appropriate index to reflect the new key value.

If you do not allow duplicate keys, VSI Pascal rejects any attempt to place a component into a file if it contains a key value that is a duplicate of an existing component. If you do not explicitly create the file to accept alternate key values, then attempts to change key values generate an error.

For More Information:

- On the **KEY** attribute (Section 10.2.23)
- On additional key characteristics (*VSI Pascal for OpenVMS User Manual*)

9.2. Component Formats

When you declare a file variable in your program, VSI Pascal automatically creates a file buffer variable of the component type. This variable takes on the value of one file component at a time. You can access only one file component, called the **current component**, at a given time.

You cannot perform operations on a file while a reference to the file buffer variable exists. To dereference the file buffer variable, write the name of the file buffer variable followed by a circumflex (^), the dereferencing character.

Predeclared I/O procedures move the file position. As the file position changes, the variable in the file buffer changes. Figure 9.5 shows how this change occurs.

Figure 9.5. File Buffer Contents

one file component

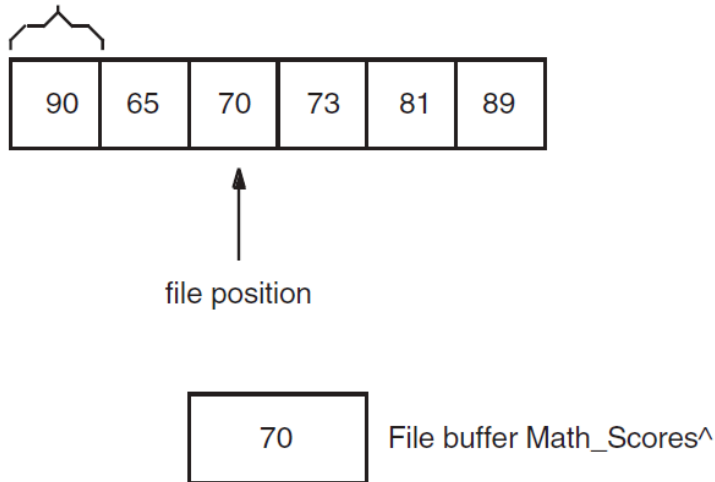

ZK-0101-GE

Suppose you declare a file variable `Math_Scores` of type `FILE OF INTEGER`. You might call a procedure to move the file position to the first component of this file. At this point, the file buffer variable `Math_Scores^` equals the value of the first component (here, 90). If you then called a procedure to advance the file position by two components, `Math_Scores^` would equal the value of the third component (here, 70).

Consider the following example:

```
VAR
f : FILE OF INTEGER;
{In the executable section:}

OPEN( File_Variable := f,
      File_Name      := 'sample.dat',
      History        := OLD,
      Organization   := Sequential,
      Access_Method  := Direct; );

EXTEND( f );
F^ := 20;
PUT( f );
```

The `OPEN` procedure opens the existing file, `sample.dat`. The `EXTEND` procedure positions the file after its last component. The assignment statement places the value 20 into the file buffer variable (`F^`). The `PUT` procedure writes the value of the file buffer variable at the end of the file, `f`.

When you declare a variable of type `FILE`, you indicate the type of all of its components. For example:

```
TYPE DataRecord = RECORD {A DataRecord is a component of this}
  Field1: INTEGER; {file; each component contains an }
  Field2: REAL;    {integer and a real value.          }
```

```

    END {RECORD};
VAR DataFile = FILE OF DataRecord; {VAR gains access to the file}

```

After calling `RESET`, `REWRITE`, or `EXTEND`, you use file variables to refer to the selected component. The following code continues the previous example:

```

RESET(DataFile);           {Read component into the file buffer}
MyInt  := DataFile^.Field1; {Copy the integer field into MyInt}
MyReal := DataFile^.Field2; {Copy the real field into MyReal}

```

The assignments use the `FILE` variable to refer to components of the file buffer.

In each file, all components are of the same file component format. **Component format** defines the size (or maximum size) of each component and any processing information needed in addition to the data portion of the component. The VSI Pascal I/O model supports the following formats for file components:

- Fixed-length format (Section 9.2.1)
- Variable-length format (Section 9.2.2)
- Stream format (Section 9.2.3)

Default Information:

For new `TEXT` and `VARYING OF CHAR` files, VSI Pascal creates variable-length components by default. For other types of new files, VSI Pascal creates fixed-length components. If you access an existing file, your specified component type must match the component type specified at the creation of the file; if it does not, you generate an error.

Table 9.2 shows which of the file organizations support which of the component formats.

Table 9.2. File Organization Support for Component Formats

Organization	Supported Component Format
Sequential	All component formats
Relative ¹	Fixed length
	Variable length
Indexed	Fixed length
	Variable length

¹Although the relative file organization allows variable-length components, those variable-length components are contained in a fixed-length cell that must be large enough to contain the largest stored component.

For More Information:

- On `TEXT` files (Section 9.5)

9.2.1. Fixed-Length Component Format

Fixed-length components are all the same length. The **fixed-length component format** is supported in all file organizations. VSI Pascal determines the length of a component at the time of file creation. You cannot change the length of the components after you create the file.

9.2.2. Variable-Length Component Format

The **variable-length component format** enables components to be only as long as the data requires. The variable-length format is supported in all file organizations.

When you use OPEN to create a file of variable-length components, you can specify the value (in bytes) of the largest component permitted in the file. Any attempt to store a component containing more bytes than the specified value results in an error.

9.2.3. Stream Component Format

The **stream component format** is a continuous stream of bytes that contains special delimiting characters (called **terminators**) that separate components. In addition to being recognized as delimiters, VSI Pascal considers the terminators to be a valid part of the component data. The stream format is supported only in sequential files on disk.

Table 9.3 contains the acceptable types of stream component formats:

Table 9.3. Acceptable Types of Stream Component Formats

Type	Description
STREAM_CR	This type recognizes a carriage-return character as the component terminator.
STREAM_LF	This type recognizes a line feed as the component terminator.
STREAM	This type uses a terminator from a limited set of special characters: the carriage return (CR); the carriage-return/line-feed combination (CR/LF); or the form feed (FF).

9.3. Component Access Modes

A **component access mode** is a method by which VSI Pascal retrieves components from a file. You cannot change the file organization or component format after file creation, but you can change the component access mode each time you access a file. The VSI Pascal I/O model defines two component access modes: sequential and random access. Random access can be further broken down into the categories of random access by number (also called **direct** access) and random access by key value (also called **keyed** access). The following sections describe these access methods in further detail.

You specify the access method using the OPEN procedure when you open a file. You cannot change the access method unless you first use the CLOSE routine, and then reopen the file specifying a new access method.

Before trying to use any of the access methods on a file, VSI Pascal determines the organization of the file. The organization determines how the specified access method works. For instance, sequential access on a sequentially organized file works differently than sequential access on an indexed file.

Default Information:

- The default is the sequential access method.
- You can always process a file using sequential access, even when the currently specified access method is one of the direct access methods.

- By default, VSI Pascal does not designate a component as a starting point for access; you must do this explicitly using one of the RESET, REWRITE, or REWIND procedures, or using an access-specific procedure to locate a specified component.

Table 9.4 shows which file organizations support which component access modes.

Table 9.4. File Organization Support for Component Access Modes

Access Mode	Sequential Organization	Relative Organization	Indexed Organization
Sequential	Yes	Yes	Yes
Random by relative component number (direct access)	Yes ¹	Yes	No
Random by key value (keyed access)	No	No	Yes

¹This access is permitted with a fixed-length component format on disk only.

For More Information:

- On file organizations (Section 9.1)
- On component formats (Section 9.2)

9.3.1. Sequential Access

Using the **sequential access method**, storage or retrieval begins at a designated position in the file and continues through the file according to the component's position in storage. You can specify two starting points for sequential access: the beginning of the file (using REWRITE, or RESET) or the end of the file (using EXTEND).

The following are the VSI Pascal I/O routines that are used for sequential access:

EOF	EXTEND	GET	PUT
READ	RESET	REWRITE	STATUS
TRUNCATE	UFB	UNLOCK	WRITE

For More Information:

- On file organization (Section 9.1)
- On component format (Section 9.2)

9.3.1.1. Sequential Access to Sequential Files

To retrieve a component in a sequential file, you must retrieve all components from the time you establish a current position (using either EXTEND, RESET, or REWRITE) to the desired component. After an operation to the file, VSI Pascal positions the file pointer to the next file component in anticipation of the next operation on the file.

To access a previous component, you must reopen (implicitly or explicitly) and reread the previous components; or, you can reopen the file, switching to random access mode.

You cannot add components in between any two components. You can add components only to the current end of the file.

Figure 9.6 shows sequential access to sequential files.

Figure 9.6. Sequential Access to a Sequential File

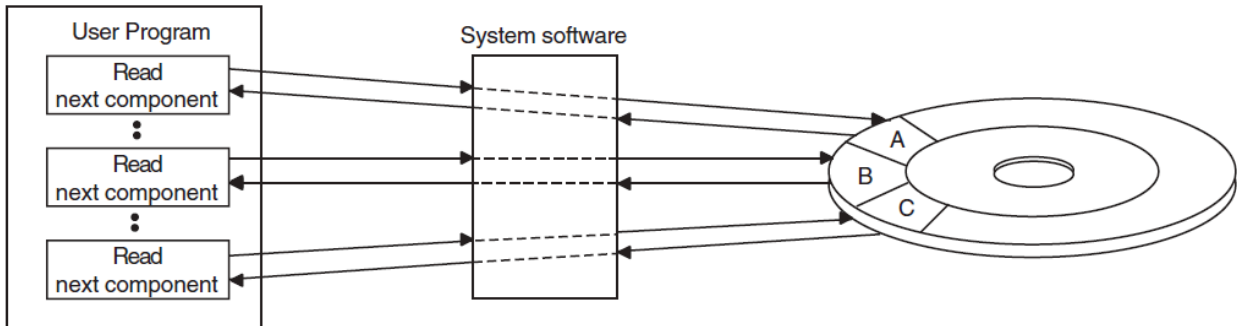

ZK-1338A-GE

9.3.1.2. Sequential Access to Relative Files

VSI Pascal can use sequential access for relative files as long as the components are fixed length. VSI Pascal tries to store or retrieve from the cell whose relative component number is one higher than the most recently accessed cell.

You cannot overwrite a component, but you can modify the contents of the current component. If the cell with the next highest relative component number contains a component and if you are trying to store data in that cell, you generate an error.

Figure 9.7 shows the use of sequential access to read from a relative file.

Figure 9.7. Using Sequential Access to Read from a Relative File

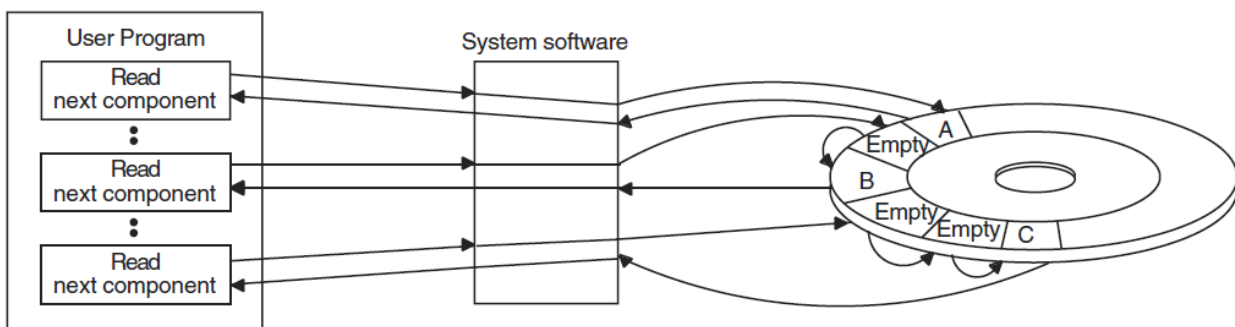

ZK-1339A-GE

Figure 9.8 shows the use of sequential access to write to a relative file. In this figure, VSI Pascal writes the component to the current cell. If the program requests that another component be stored sequentially, then VSI Pascal places that component in cell 3. If the program places another request to store a component sequentially, an error occurs because cell 4 contains component B.

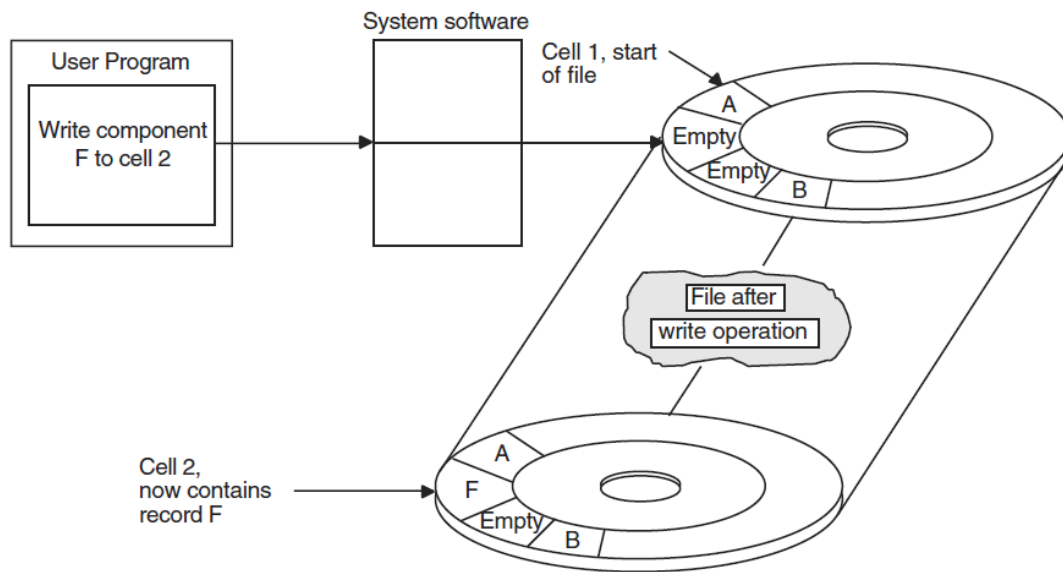
Figure 9.8. Using Sequential Access to Write to a Relative File

ZK-1340A-GE

9.3.1.3. Sequential Access to Indexed Files

When sequentially accessing an indexed file, VSI Pascal uses a specified index to determine the order in which to sequentially process the file components. The specified keys are called the **keys of reference**.

If you specify `ACCESS_METHOD := SEQUENTIAL` when you open an indexed file, you can only access components sequentially according to the primary key. If you specify `ACCESS := KEYED` when you open an indexed file, you can access components sequentially according to any key.

When sequentially writing components to an indexed file, VSI Pascal stores the component according to the primary key. If your program uses secondary keys, VSI Pascal updates the secondary key pointers to include the newly stored component.

9.3.2. Random Access

Random access allows you to access file components in an order that is not dependent on the file organization or on the order in which the components are stored. Random access is available for all relative and indexed files, and for sequential files composed of fixed-length components (the fixed-length components allow VSI Pascal to count component positions in the sequential file without having to worry about variations in the lengths of the components).

VSI Pascal supports the following types of random access:

- Random access by relative component number (direct access)
- Random access by key value (keyed access)

The following are the VSI Pascal I/O routines that are used for random access:

Random access by relative component number:			
DELETE	EOF	FIND	LOCATE

Random access by relative component number:			
UFB	UNLOCK	UPDATE	
Random access by key:			
EOF	FINDK	RESETK	UFB
UNLOCK	UPDATE		

For More Information:

- On file organization (Section 9.1)
- On component format (Section 9.2)

9.3.2.1. Random Access by Relative Component Numbers (Direct Access)

VSI Pascal supports random access by relative component numbers for relative files and for sequential files with fixed-length components on disk. To access the desired component, you need to specify the relative component number of the corresponding cell; relative component numbers are relative to the beginning of the file.

Figure 9.9 shows the process of randomly accessing cells in a file. For random access of sequential files, the cells must be of a fixed length.

Figure 9.9. Using Random Access on Sequential and Relative Files

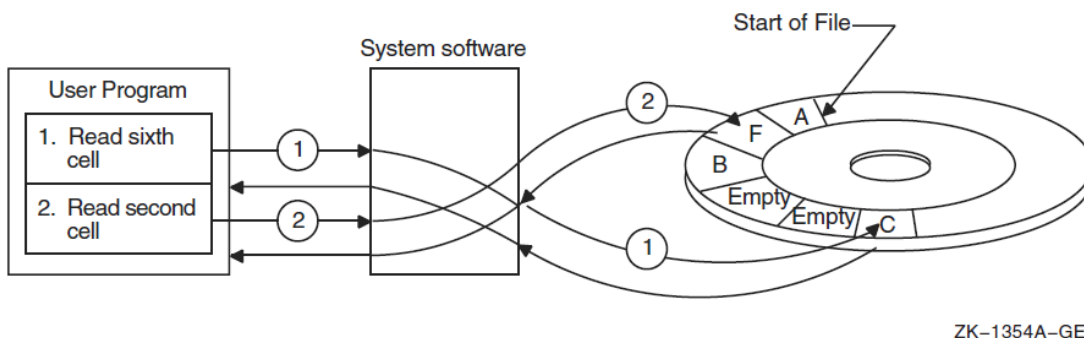

ZK-1354A-GE

9.3.2.2. Random Access to Indexed Files (Keyed Access)

VSI Pascal supports random access to indexed files. To retrieve a component, you must specify an index (primary index, first alternate index, second alternate index, and so forth) and a key value. To store a component, VSI Pascal determines existing keys from the file organization and stores the record (and alternate key information) according to information as it exists in the data portion of the component.

Your program can use several methods to randomly access a record by key:

- Exact match of key values.
- Approximate match of key values. When accessing an index in ascending sort order, VSI Pascal returns the component that has the next higher key value (in descending order, the component with next lower key value).

- Generic match of key values. Generic matching is applicable to string data-type keys only (PACKED ARRAY OF CHAR record fields). For a generic match, the program need specify only a match of some specified number of leading characters in the key.
- Combination of approximate and generic match.

9.4. File Locking

Under some circumstances, if a file component is in the process of being read or written to by one program, VSI Pascal **locks** the component, preventing other programs from accessing the component. This prevents programs from accessing outdated or inaccurate data.

If you OPEN a file and specify that the file is not to be shared, or that reading or writing sharing is allowed, VSI Pascal may not lock the record.

Record locking occurs most often when accessing relative and indexed files, but it can happen when accessing sequential files as well. Successful calls to FIND, FINDK, GET, RESET, and RESETK lock the current component. If you want to make a locked file component available to other programs on the system, you can call the UNLOCK procedure.

For More Information:

- On enabling other programs to access new files created with OPEN (Section 9.8.11)
- On unlocking components (Section 9.8.22)

9.5. TEXT Files

Files of type TEXT are sequences of characters with special markers (end-of-line and end-of-file) added to the file. Although each character of a TEXT file is one file component, the end-of-line marker allows you to process the file line by line (using READLN, WRITELN, or EOLN), if you choose.

The predeclared file variables INPUT and OUTPUT are files of type TEXT. They refer to the standard input and output files. (When executing programs at a terminal, INPUT and OUTPUT default to the terminal you are using.)

The file type FILE OF CHAR differs from TEXT files in that FILE OF CHAR allows a single character to be the unit of transfer between a program and its associated I/O devices, and that FILE OF CHAR files do not include special markers. FILE OF CHAR components are always read with the READ procedure, and must be read exclusively into variables of type CHAR, including CHAR components of structured variables. You cannot use the EOLN, READLN, and WRITELN routines on FILE OF CHAR files.

Default Information:

- A new file of type TEXT or FILE OF VARYING OF CHAR is a sequential file with variable-length components.
- All TEXT file routines use the predefined files INPUT and OUTPUT by default.

- VSI Pascal performs an implicit call to RESET on the predeclared file INPUT and an implicit call to REWRITE on the predeclared file OUTPUT.
- The default size for the output buffer is 255 characters for TEXT files.

The following are the VSI Pascal I/O routines that are used only with TEXT files: EOLN, LINELIMIT, PAGE, READLN, and WRITELN.

9.5.1. Carriage Control

Some devices, such as printers and terminals, are carriage-control devices and require characters to provide information regarding output. VSI Pascal supports the following carriage-control options:

OPEN Parameter Option	Description
LIST	Single spacing between components. This is the default carriage-control option for all TEXT files (including OUTPUT) and VARYING OF CHAR files.
CARRIAGE, FORTRAN	The first character of every output line is a carriage-control character.
NONE, NOCARRIAGE	No carriage control. This is the default for all files other than TEXT and VARYING OF CHAR files.

For FORTRAN carriage control, if output is directed to devices that do not use carriage-control characters, the character is written into the file as a component and is read back when the file is opened for input. If output is directed to devices that do use carriage control, then the OPEN parameter options described previously determine the action taken by VSI Pascal.

Table 9.5 summarizes carriage-control characters and their effects. For purposes of carriage control, VSI Pascal ignores any characters other than those listed in the table.

Table 9.5. Carriage-Control Characters

Character	Meaning
'+'	Overprinting: starts output at the beginning of the current line.
' '	Single spacing: starts output at the beginning of the next line.
'0'	Double spacing: skips a line before starting output.
'1'	Paging: starts output at the top of a new page.
'\$'	Prompting: starts output at the beginning of the next line and suppresses carriage return at the end of the line.
' '(0)	Prompting with overprinting: suppresses line feed at the beginning of the line and carriage return at the end of the line; note that this character is the ASCII character NUL.

9.5.2. Prompting on a Terminal

Normally, when you call the WRITE procedure to access a TEXT file connected to a terminal, VSI Pascal accumulates the characters in a line buffer until a subsequent WRITELN procedure is executed. In effect, WRITELN generates an end-of-line marker. When you complete a line or close a file, VSI Pascal writes a full line of characters to the specified TEXT file.

VSI Pascal can manipulate partial lines in a TEXT file; however, when characters are being written to a terminal output file opened with the LIST carriage-control option (LIST is the default), partial lines are written to the terminal before input is transferred from any terminal to the line buffer of a TEXT file. In this situation, VSI Pascal searches for all TEXT files opened for output on terminals; it then writes to those files any partial lines contained in the files' respective line buffers. These partial lines, called prompts, appear on the screen. You respond to a prompt by typing a line of input data terminated by pressing Return.

Consider the following example:

```
WRITE( 'Name three presidents:' );
READ( Pres1, Pres2, Pres3);
```

VSI Pascal stores the string 'Name three presidents: ' in the output buffer; when executing the READ procedure, VSI Pascal locates the TEXT file opened for output to the appropriate terminal and the partial output buffer is written, causing the string 'Name three presidents: ' to appear on the terminal screen. The user can then begin typing on the same line as the prompt, providing the names of three presidents. Note that prompting works only for files associated with interactive terminals. For any other files, VSI Pascal does not write output until you start the new line with a WRITELN procedure.

9.5.3. Delayed Device Access to Text Files

The Pascal standard requires that the file buffer always contain the next file component that will be processed by the program. This definition can cause problems when the input to the program depends on the output most recently generated. To alleviate such problems in the processing of the TEXT files, VSI Pascal uses a technique called **delayed device access**, also known as **lazy lookahead**.

As a result of delayed device access, VSI Pascal does not retrieve an item of data from a physical file device and does not insert it in the file buffer until the program is ready to process it. VSI Pascal fills the file buffer when the program makes the next reference to the file. A reference to the file consists of any use of the file buffer variable, including its implicit use in the GET, READ, and READLN procedures, or any test for the status of the file, namely, the EOF, EOLN, STATUS, and UFB functions.

The RESET procedure, which is required when any TEXT file is opened for input, initiates the process of delayed device access. (Note that RESET is done automatically on the predeclared file INPUT.) RESET expects to fill the file buffer with the first component of the file. However, because of delayed device access, an item of data is not supplied from the input device to fill the file buffer until the next reference to the file.

When writing a program for which the input will be supplied by a TEXT file, you should be aware that delayed device access occurs. Because RESET initiates delayed device access, and because EOF and EOLN cause the file buffer to be filled, you should place the first prompt for input before any tests for EOF or EOLN. The information you enter in response to the prompt supplies data that is retained by the file device until you make another reference to the input file.

Consider the following example:

```
VAR
i : INTEGER;
{In the executable section:}
WRITE( 'Enter an integer or an empty line: ' );
WHILE NOT EOLN DO
  BEGIN
    READLN( i );
    WRITELN( 'The integer was: ', i:1 );
```

```
    WRITE( 'Enter an integer or an empty line: ' );
    END;
WRITELN( 'Done' );
```

The first reference to the file INPUT is the EOLN test in the WHILE statement. When the test is performed, VSI Pascal attempts to read a line of input from the TEXT file. Therefore, it is very important to prompt for the integer or empty line before testing for EOLN.

Suppose you respond to the first prompt by supplying an integer as input. Access to the input device is delayed until the EOLN function makes the first reference to the file INPUT. The EOLN function causes a line of text to be read into the internal line buffer. The subsequent READLN procedure reads the input value from the line of text and assigns it to the variable *i*. The WRITELN procedure writes the input value to the text file OUTPUT. The final statement in the WHILE loop is the request for another input value. The loop terminates when EOLN detects the end-of-line marker.

A sample run of a program containing this loop might be as follows:

```
Enter an integer or an empty line: 10
The integer was: 10
Enter an integer or an empty line: 99
The integer was: 99
Enter an integer or an empty line: [Return]
Done
```

The following program fragment shows a method of writing the same loop that does not take into account delayed device access so it produces incorrect results:

```
WHILE NOT EOLN DO
BEGIN
WRITE( 'Enter an integer or an empty line: ' );
READLN( i );
WRITELN( 'The integer was: ', i:1 );
END;
```

The EOLN test at the beginning of the loop causes the file buffer to be filled. However, because no input has been supplied yet, the prompt does not appear on the screen until you have supplied input to fill the INPUT file buffer.

A sample run of a program containing this loop might be as follows:

```
10
Enter an integer or an empty line: The integer was: 10
99
Enter an integer or an empty line: The integer was: 99
[Return]
```

The prompt always appears after you type a value for *i*.

Delayed device access can produce unexpected results if you try to use the STATUS function to test the status of a TEXT file after you have performed a READLN procedure on the file. Remember that a READLN procedure call actually performs a READ procedure on each variable listed as a parameter, then performs a READLN procedure to position the file at the beginning of the next line. Therefore, a call to STATUS after a READLN procedure actually tests whether the file was successfully positioned. To test the status of the file, STATUS causes delayed device access to occur, which fills the file buffer with the next component. If you want to test the successful reading of data from the input file, read the data with the READ procedure, call the STATUS function, and then perform a READLN procedure to advance the file to the beginning of the next line.

9.5.4. Writing Partial Lines to Terminals

The WRITE procedure buffers output to the terminal until the WRITELN procedure is called. If too many characters are buffered, it can cause the VSI Pascal buffer to overflow. The default size for this buffer is 255 characters for TEXT files. If you want to increase the internal buffer size, you can explicitly open the predeclared file OUTPUT with a larger record length. Consider the following example:

```
OPEN( OUTPUT, RECORD_LENGTH := 512 );
```

If you want each record to go directly to the terminal without buffering until the next WRITELN, you can explicitly open the predeclared file variable OUTPUT without carriage control. In this mode, the WRITELN procedure will write the information to the file without adding any carriage control. However, you need to include the carriage return and the line-feed characters in the output strings; the WRITELN procedure no longer provides these automatically. Consider the following example:

```
CONST
LF = 10; {ASCII control characters}
CR = 13;
{In the executable section:}
OPEN( OUTPUT, CARRIAGE_CONTROL := NONE );
WRITELN( '(LF)'Output this' );
WRITELN( 'string directly' );
WRITELN( 'to the terminal'(CR) );
```

This is useful when you are writing escape sequences or other graphics characters to terminal devices.

9.6. Formatting Output

The output values of a WRITE, WRITELN, or WRITEV procedure can be compile-time or run-time expressions, with values of any ordinal, real, or string type. Each value is written with a default field width, which specifies the minimum number of characters to be written for the value. You can, however, override the default as described in Section 9.6.1, Section 9.6.2, and Section 9.6.3. Table 9.6 lists the default field widths.

Table 9.6. Default Field Widths

Type of Item Printed	Number of Characters
INTEGER	10
UNSIGNED	10
INTEGER64	19
UNSIGNED64	20
CHAR	1
BOOLEAN	6
Enumerated	Size of the longest identifier plus 1, up to 32
REAL	12
DOUBLE	20
QUADRUPLE	40
Character string	Length of string

9.6.1. Specifying the Field Width

When you write any value, you can specify a field width to override the default. The format is identical for the WRITE, Writeln, and WRITEV procedures. The formats are:

REAL format

```
output[[:minimum[[:fraction]] ]]
```

INTEGER format

```
output[[:minimum [[:radix]] ]]
```

String, Boolean, and enumeration format

```
output:minimum
```

```
output
```

The expression to be written, as you would write it without specifying the field width.

```
minimum
```

A nonnegative integer expression for the minimum number of characters to be written for the value. Pascal uses a greater field width if required by the magnitude of the number to be printed.

```
fraction
```

The fraction, which is permitted only for values of real types, indicates the number of digits to be written to the right of the decimal point.

```
radix
```

The radix, which is permitted only for values of integer types, specifies the use of a base notation other than decimal.

If you try to write a number is too large to fit in the field that you specify, Pascal extends the field instead of removing digits and writing an incorrect number. If you specify a field width that is larger than necessary, Pascal prints blanks to the left of the number, right-justifying it.

If you try to write a value of an enumerated type, a Boolean value, a character, or a string value in a field that is too narrow, the value is truncated on the right. The truncated identifier is not checked for uniqueness.

9.6.2. Writing Real Numbers

By default, real numbers are written in exponential format. Regardless of the real number's type, output procedures always prefix the exponent with the letter E. Each real number in exponential format is preceded by a blank or a minus sign, and the value of the rightmost digit is rounded. Consider the following example:

```
Writeln( Shoe_Size );
```

If the value of Shoe_Size is 12.5, this procedure produces the following output:

```
1.25000E+01
```

To write the value in decimal format, you must specify a field width as in this example:

```
WRITELN( Shoe_Size:5:1 );
```

The first integer indicates that a minimum of five characters will be written. The minimum includes the minus sign, if needed, and the decimal point. The second integer specifies one digit to the right of the decimal point. The resulting output is as follows:

```
12.5
```

If the field specified is wider than necessary, the value is written with leading blanks.

If you try to write a real value in a field that is too narrow, the field width is expanded to the minimum necessary to write the value.

9.6.3. Explicitly Specifying the Base

To write integers in a base other than decimal, supply the second run-time expression, which specifies the base, or radix.

```
integer-expression : fieldwidth : radix
```

```
radix
```

Any run-time integer expression with a value from 2 through 36 inclusive. If you specify a base greater than 10, letters A through Z denote the extra digits. For example, when you output in hexadecimal (base 16), the characters A through F are the extra six digits.

If the integer-expression denotes a negative number, a leading minus sign is printed and the absolute value of the expression is converted into the selected radix.

9.6.4. Specifying the Base with Predeclared Conversion Functions

You can use the predeclared conversion functions BIN, DEC, UDEC, HEX, and OCT in combination with the WRITE, WRITELN, and WRITEV procedures to write binary, decimal, unsigned decimal, hexadecimal, and octal values. The DEC and UDEC functions return values with leading zeros; by default, the I/O routines use leading blank with decimal numbers, not leading zeros. The syntax is:

```

                                     {BIN   }
                                     {DEC   }
WRITE( [[file_variable, ]] {UDEC } ( expression[[,
  length[[,digits]] ]] ) ,...)
                                     {HEX   }
                                     {     }
                                     {OCT   }
```

The predeclared conversion functions convert the value of the first expression in the list to its equivalent as a binary, decimal, unsigned decimal, hexadecimal, or octal number. The resulting digits are returned in a VARYING OF CHAR string.

For every expression whose binary, decimal, unsigned decimal, hexadecimal, or octal value you wish to write, you must call the appropriate conversion function separately with an actual parameter list. You can call more than one conversion function in the same output procedure call. You can write variables

of any type (including pointers) to text files in binary, decimal, unsigned decimal, hexadecimal, or octal notation.

You can specify field widths with the conversion functions; however, the results are not likely to be what you expect. For example, if you want to convert the value of `i` to its hexadecimal equivalent and you want the converted value to be written in a field three characters wide, you might write the following procedure call:

```
WRITELN( HEX( i ):3 );
```

However, because the converted value is longer than the field width specification, the value is truncated on the right rather than on the left. Therefore, the output generated by this procedure would be as follows:

```
00
```

Be careful about specifying field widths with `BIN`, `DEC`, `UDEC`, `HEX`, and `OCT` when the converted value could exceed the field width given.

Consider the following example:

```
WRITE( HEX( Payroll, 10 ), HEX( Salary, 12 ) );
```

The values of the variables `Payroll` and `Salary` are converted to their hexadecimal equivalents. `Payroll` is printed with 10 characters and `Salary` is printed with 12 characters. The output values, preceded by two initial blanks, could look like this:

```
000031F2    000058AB
```

Consider the following example:

```
WRITELN( OCT( Social_Security, 14 ), BIN( Survey, 8 ) );
```

The value of the variable `Social_Security` is converted to its octal equivalent and printed with 14 characters. The value of the variable `Survey` is then converted to its binary equivalent and printed with eight characters. A sample line of output, preceded by three blanks, could look like this:

```
0271137762500101110
```

Consider the following example:

```
WRITEV( Final_Balance, OCT( Debits, 16 ), OCT( Credits, 16 ) );
```

The values of the variables `Debits` and `Credits` are converted to their octal equivalents and written to the string variable `Final_Balance` with 16 characters each. The output string, preceded by five blanks, could look like this:

```
'    77777770342    00000033766'
```

9.6.5. Writing Nonnumeric Types

For an expression of an enumerated type, the constant identifier denoting the expression's value is written. Consider the following example:

```
VAR  
Color : ( Blue, Yellow, Black, Fire_Engine_Green );  
{In the executable section:}
```

```
WRITE( 'My favorite color is ', Color:15 );
```

When the value of Color is Yellow, the following is written:

```
My favorite color is          YELLOW
```

When the value of Color is Fire_Engine_Green, the following appears:

```
My favorite color is FIRE_ENGINE_GRE
```

Because the field width specified in these cases is not wide enough for all 17 characters in the identifier, the identifier is truncated after the field is filled.

For More Information:

- On the WRITE procedure (Section 9.8.24)
- On the WRITELN procedure (Section 9.8.25)
- On the WRITEV procedure (Section 8.107)
- On the BIN function (Section 8.11)
- On the DEC function (Section 8.26)
- On the UDEC function (Section 8.93)
- On the HEX function (Section 8.41)
- On the OCT function (Section 8.60)

9.7. Error-Processing Parameter

For I/O procedures, the last parameter (which is optional) specifies the action to be taken should the procedure fail to execute successfully. You must use nonpositional syntax in order to pass the error-recovery parameter to the called procedure. This parameter is called ERROR and can accept two values: CONTINUE and MESSAGE.

If you specify ERROR := CONTINUE, the program continues to execute regardless of any error conditions encountered during execution of the procedure. If you specify this value, you should use the STATUS function to be certain that the I/O routine worked as expected.

If you specify ERROR := MESSAGE and if an error occurs, VSI Pascal generates an appropriate error message and program execution stops. By default, VSI Pascal displays an error message and program execution stops after the first error in an I/O operation.

You cannot use the error-recovery parameter with the I/O functions EOF, UFB, and EOLN, nor with any reference to the file buffer.

9.8. I/O Routines

VSI Pascal provides predeclared procedures and functions to perform input and output operations on file variables. These routines may operate differently depending on a file's organization and the currently defined access method.

The I/O routines in the following sections appear in alphabetical order. To save you the time of scrolling through all the routines, you may wish to click on the Table Of Contents entry for the desired routine.

At any time during the execution of a process, a file variable is considered to be in one of three modes: **inspection**, **generation**, or **undefined**. When a file is reading input, it is in inspection mode. When output is being written to a file, the file is in generation mode. A file in an undefined state of processing is in undefined mode. The mode often determines the valid operations for the file.

Table 9.7 shows the mode required before execution of each I/O routine and shows the mode in which the file is left after each routine has executed.

Table 9.7. File Mode During I/O Processing

I/O Routine	Mode Before Execution	Mode After Execution	I/O Routine	Mode Before Execution	Mode After Execution
CLOSE	Any	Undefined	READ	Inspection	Inspection
DELETE	Inspection	Inspection	READLN	Inspection	Inspection
EOF	Inspection or generation	No change	RESET	Any	Inspection
EOLN	Inspection	Inspection	RESETK	Any	Inspection
EXTEND	Any	Generation	REWRITE	Any	Generation
FIND	Any	Inspection if successful; undefined if unsuccessful	STATUS	Any	No change, unless error
FINDK	Any	Inspection if successful; undefined if unsuccessful	TRUNCATE	Inspection	Generation
GET	Inspection	Inspection	UFB	Any	No change
LINELIMIT	Any	No change	UNLOCK	Inspection	Inspection
LOCATE	Any	Generation	UPDATE	Inspection	Inspection
OPEN	Undefined	Undefined	WRITE	Generation, unless keyed access, which may be any mode	Generation
PAGE	Generation	No change	WRITELN	Generation	Generation
PUT	Generation	Generation			

9.8.1. CLOSE Procedure

The CLOSE procedure closes an open file. You can use either positional or nonpositional syntax in the call.

```
1. CLOSE (file_variable
         , [[disposition]]
         , [[user_action]]
         , [[ERROR := error_recovery]] )
```

```
2. CLOSE ( FILE_VARIABLE := file_variable
           [[,DISPOSITION := disposition]]
           [[,USER_ACTION := user_action]]
           [[,ERROR := error_recovery ]] ...)
```

file_variable

The name of the file variable associated with the file that VSI Pascal is to close.

disposition

A value that determines what VSI Pascal is to do with the file after closing it. The disposition values are the same as those used for the OPEN procedure. The disposition value in the CLOSE procedure supersedes a disposition value specified in the OPEN procedure.

user_action

A routine name that VSI Pascal calls to close the file. You can use a user-action routine to close the file using environment-specific capabilities.

error_recovery

The action to be taken if an error occurs during execution of the routine.

Execution of the CLOSE procedure causes the system to close the file and, if the file is internal, to delete it. Each file is automatically closed when control passes from the block in which it is declared.

You cannot close a file that has not been opened (either explicitly by the OPEN procedure, or implicitly by the EXTEND, RESET, or REWRITE procedure). If you try to close a file that was never opened, an error occurs.

The file can be in any mode (inspection, generation, or undefined) before the CLOSE procedure is called. Execution of CLOSE sets the mode to undefined.

For More Information:

- On positional and nonpositional syntax (Section 6.3.8)
- On the OPEN procedure and parameters (Section 9.8.11)
- On the error-processing parameter (Section 9.7)

9.8.2. DELETE Procedure

The DELETE procedure deletes the current file component. DELETE can be used only on files with relative or indexed organization that have been opened for direct or keyed access; it cannot be used on files with sequential organization.

```
DELETE( file_variable[[, ERROR := error-recovery]] );
```

file_variable

The name of the file variable associated with the file from which a component is to be deleted.

error-recovery

The action to be taken if an error occurs during execution of the routine.

The file must be in inspection mode before DELETE is called; the mode does not change after the procedure's execution.

When the DELETE procedure is called, the current component, as indicated by the file buffer, must already have been locked by a successful FIND, FINDK, GET, RESET, or RESETK procedure before it can be deleted. After deletion, the component is unlocked and the UFB function returns TRUE.

Consider the following example:

```
DELETE( Accounts_Payable );
```

This procedure call deletes the current component. When the component has been deleted, it is unlocked and UFB(Accounts_Payable) returns TRUE. A run-time error occurs if the current component of Accounts_Payable is not locked.

For More Information:

- On file organizations (Section 9.1)
- On component access (Section 9.3)
- On the UFB function (Section 9.8.21)
- On the error-processing parameter (Section 9.7)

9.8.3. EOF Function

The EOF function indicates whether the file pointer is positioned after the last component in a file by returning a Boolean value.

```
EOF[[ (file_variable) ]]
```

file_variable

The name of the file variable associated with the input file. If you omit the name of the file, the default is INPUT.

The file can be in either inspection or generation mode before EOF is called; however, end-of-file must be defined. The input operations GET, RESET, and FINDK are guaranteed to leave end-of-file defined. The file mode does not change after EOF has been executed.

EOF returns TRUE when the file pointer is positioned after the last component in the file, and returns FALSE up to and including the time when the last component of the input file is read into the file buffer. You must try to retrieve another file component after the last to determine whether the file is positioned at end-of-file.

When EOF is tested for a file with relative organization opened for direct access, the result is TRUE if the file is in inspection mode and the last GET or RESET operation positioned the file beyond the last existing component. If the file is in generation or undefined mode, the result of EOF is undefined.

When EOF is tested for a file with indexed organization opened for keyed access, the result is TRUE if the file is in inspection mode and the last FINDK, GET, RESET, or RESETK operation positioned the file beyond the last component with the current key number. Successful attempts at FINDK, GET, RESET, and RESETK cause EOF to be FALSE. If the file is not in inspection mode, EOF is undefined.

If you try to read a file after EOF becomes TRUE, an error results.

Consider the following example:

```
Coupons := 0;
WHILE NOT EOF DO
  BEGIN
    READLN( Coupon_Amount );
    Coupons := Coupons + Coupon_Amount;
  END;
```

This example calculates the total value of the coupons contained in the file INPUT. The loop is performed while the EOF function returns FALSE.

For More Information:

- On component access (Section 9.3)
- On the error-processing parameter (Section 9.7)
- On retrieval of file components (Section 9.5.3)

9.8.4. EOLN Function

The EOLN function tests for the end-of-line marker within a text file and returns a Boolean value.

```
EOLN [(file_variable)]
```

file_variable

The name of a file variable associated with a text file. If you omit the name of the file, the default is INPUT.

The file must be in inspection mode and EOF must return FALSE before EOLN is called. EOLN leaves the file in inspection mode.

The Boolean EOLN function returns TRUE when the file pointer is positioned after the last character in a line. When the EOLN function returns TRUE, the file buffer contains a blank character.

The EOLN function returns FALSE when the last component in the line is read into the file buffer. Another character must be read to cause EOLN to return TRUE and to cause the file buffer to be positioned at the end-of-line marker following the last character of the line. If you use the EOLN function on a nontext file, an error occurs.

Consider the following example:

```
WHILE NOT EOF( Master_File ) DO
  BEGIN
    WHILE NOT EOLN( Master_File ) DO
      BEGIN
        READ( Master_File, x );
        IF NOT (x IN ['A'..'Z', 'a'..'z', '0'..'9'])
          THEN
            Err := Err + 1;
          END;
        READLN( Master_File );
      END;
  END;
```

This example scans the characters on each line of a TEXT file called Master_File and checks for characters that are neither digits nor letters. If a nonnumeric or nonalphabetic character is encountered in the file, the counter Err is incremented by 1. The loop is executed until the last component in the file is read.

For More Information:

On TEXT files (Section 9.5)

9.8.5. EXTEND Procedure

The EXTEND procedure opens an existing file, positions the file buffer after the last component, and prepares it for writing. It is commonly used to append to a file.

```
EXTEND( file_variable [[, file_name]] [[, ERROR := error-recovery]] );
```

file_variable

The name of the file variable associated with the output file.

file_name

String expression for the file name to be associated with the file_variable. If the file is already open, an error is signaled.

error-recovery

The action to be taken if an error occurs during execution of the routine.

The file can be in any mode before EXTEND is called to set the mode to generation. If the file is an external file and is not already open, EXTEND opens it using the defaults for the OPEN procedure.

After execution of EXTEND, the file is positioned after the last component and EOF and UFB return TRUE. If the file does not exist, EXTEND does not create it but returns an error at run time.

A call to EXTEND on a relative file opened for direct access positions the file after its last existing component.

A call to EXTEND on an indexed file opened for random access by key positions the file after the last component relative to the primary key.

Consider the following example:

```
VAR
  f : FILE OF INTEGER;
{In the executable section:}

OPEN( File_Variable := f,
      File_Name      := 'sample.dat',
      History        := OLD,
      Organization   := Relative,
      Access_Method  := Direct; );

EXTEND( f );
F^ := 20;
PUT( f );
```

These statements open an existing relative file named `sample.dat`. The file will be positioned after the last record in the file. Subsequent `PUT` statements will append new components to the end of the file.

For More Information:

- On component access (Section 9.3)
- On default values for the `OPEN` procedure (Section 9.8.11)
- On the error-processing parameter (Section 9.7)

9.8.6. FIND Procedure

The `FIND` procedure positions a file at a specified component. The file must be open for direct access and must contain fixed-length components.

```
FIND( file_variable, component-number [[, ERROR := error-recovery]] );  
  
file_variable
```

The name of a file variable associated with a file that is open for direct access.

```
component-number
```

A positive integer expression that indicates the component at which the file is to be positioned. If the component number is zero or negative, a run-time error occurs.

```
error-recovery
```

The action to be taken if an error occurs during execution of the routine.

The `FIND` procedure allows direct access to the components of a file. You can use the `FIND` procedure to move forward or backward in a file.

After execution of the `FIND` procedure, the file is positioned at the specified component. The file buffer variable assumes the value of the component, and the file mode is set to inspection. If the file has relative organization, the current file component is locked. If there is no file component at the selected position, the file buffer is undefined (`UFB` becomes `TRUE`) and the mode becomes undefined. After any call to `FIND`, the value of `EOF` is undefined.

You can use the `FIND` procedure only when reading a file that was opened by the `OPEN` procedure. If the file is open because of a default open (that is, with `EXTEND`, `RESET`, or `REWRITE`), a call to `FIND` results in a run-time error because the default access method is sequential.

Consider the following example:

```
FIND( Albums, Current + 2 );
```

If the value of `Current` is 6, this procedure causes the file position to move to the eighth component; the file buffer variable `Albums^` assumes the value of the component. If no eighth component exists, `Albums^` is undefined and `UFB (Albums)` returns `TRUE`.

For More Information:

- On component access (Section 9.3)

- On the UFB function (Section 9.8.21)
- On the error-processing parameter (Section 9.7)

9.8.7. FINDK Procedure

The FINDK procedure searches the index of an indexed file opened for keyed access and locates a specific component.

```
FINDK( file_variable, key-number, key-value[[, match-type]]  
      [[, ERROR := error-recovery]] );
```

`file_variable`

The name of the file variable associated with the file to be searched.

`key-number`

A positive integer expression that indicates the key position.

`key-value`

An expression that indicates the key to be found; it must be assignment compatible with the key field in the specified key position.

`match-type`

An identifier that indicates the relationship between the key value in the FINDK procedure call and the key value of a component.

`error-recovery`

The action to be taken if an error occurs during execution of the routine.

When you establish key fields with the KEY attribute, you assign each one a key number from 0 to 254. Key number 0 represents the mandatory primary key of the file. Separate indexes are built for each key number in the file.

The key value and the match type provide information about the key to be found. The key value must be assignment compatible with the key fields of the key number being searched. The match type must be one of the following identifiers:

- EQL—equal to the key value
- NXT—the next key in the collating sequence after the key value
- NXTEQL—the next or equal key in the collating sequence after the key value

If the FINDK procedure was used on an ascending collating sequence, NXT and NXTEQL would be equivalent to GTR and GEQ. If a descending collating sequence was used, it would be the same as LSS and LEQ. The match type is optional; if omitted, it defaults to EQL.

The FINDK procedure can be called for any indexed file opened for keyed access, regardless of the file's mode. If the component described exists, the file buffer is filled with that component; UFB and EOF both become FALSE. The mode is set to inspection and the component is automatically locked. If no

component is found to match the description, UFB becomes TRUE and EOF is undefined. The mode is set to undefined.

Consider the following example:

```
FINDK( Book_Index, 1, 35, NXTEQL );
```

Assuming key number 1 is ascending, this procedure searches the index for key number 1 in the file `Book_Index` until it finds the first component whose key value is greater than or equal to 35. If the component matching the description in the `FINDK` statement is found, `UFB(Book_Index)` and `EOF(Book_Index)` return FALSE, and the component is locked. If the component cannot be found, `UFB(Book_Index)` returns TRUE, and `EOF(Book_Index)` is undefined. `Book_Index` must be an indexed file opened for keyed access.

For More Information:

- On indexed files (Section 9.1.3)
- On random access by key (Section 9.3.2)
- On the UFB function (Section 9.8.21)
- On the error-processing parameter (Section 9.7)

9.8.8. GET Procedure

The `GET` procedure advances the file position and reads the next component of the file into the file buffer variable. If the file has relative or indexed organization, the component is also locked to prevent access by other processes.

```
GET( file_variable [[, ERROR := error-recovery]] );
```

`file_variable`

The name of the file variable associated with the input file.

`error-recovery`

The action to be taken if an error occurs during execution of the routine.

Before the `GET` procedure is used for the first time to read one or more file components, the file must be in inspection mode and prepared for reading input. Depending on the access method specified when the file was opened, you can prepare the file for input in the following ways:

- If the file is open for sequential access, call the `RESET` procedure. `RESET` sets the mode to inspection, advances the file position to the first component, and assigns the component's value to the file buffer variable.
- If the file is open for direct access, call either the `RESET` or the `FIND` procedure to position the file.
- If the file is open for keyed access, call the `FINDK`, `RESET`, or `RESETK` procedure to position the file.

As a result of the `GET` procedure, the file remains in inspection mode, and the file position advances to the next component. If a component is found other than the end-of-file marker, the component is locked, `EOF` is set to FALSE, the file buffer variable takes on the value of the component, and `UFB` is set to

FALSE. If a component is not found or the end of the file is reached, EOF and UFB are set to TRUE. If the GET procedure fails, UFB is set to TRUE and EOF becomes undefined. The following example shows the use of the GET procedure:

```
RESET( Books ); New_Rec := Books^; GET( Books );
```

After execution of the RESET procedure, the value of the file buffer variable Books[^] is equal to the value of the first component of the file. The assignment statement assigns this value to the variable New_Rec. The GET procedure then assigns the value of the second component to Books[^], advancing the file position to the second component. Another GET procedure advances the file position to the Third component. Figure 9.10 shows this sequence of events.

Figure 9.10. File Position After GET Procedure

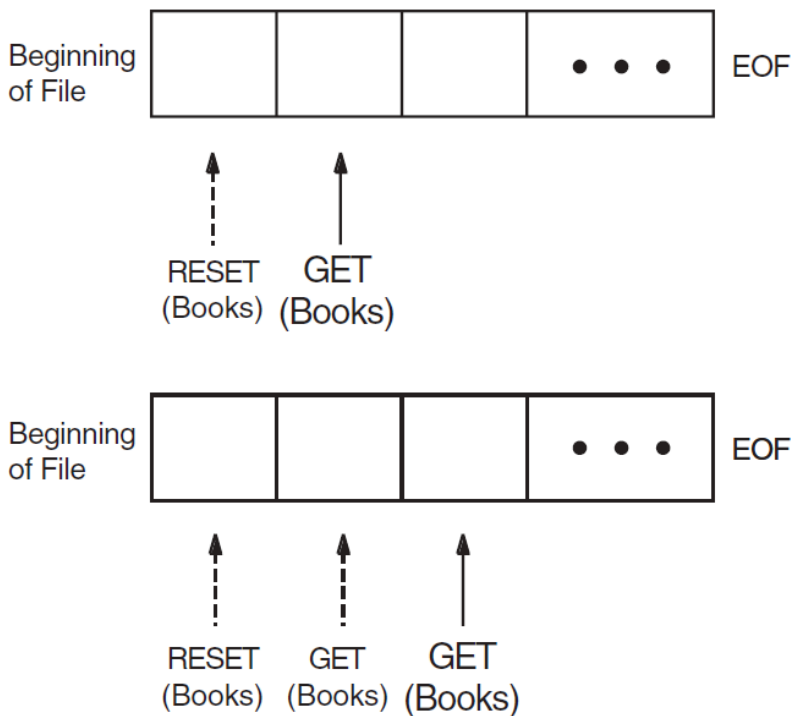

ZK-0103-GE

By using the GET procedure repeatedly, you can read sequentially through a file. When called for a file with relative organization, GET skips any nonexistent components to find the next component.

When you reach the end of the file and EOF returns TRUE, a GET procedure results in a run-time error.

Consider the following example:

```
GET( Phones );
```

This example reads the next component of the file Phones into the file buffer variable Phones[^]. Prior to executing GET, the value of EOF (Phones) must be FALSE; if it is TRUE, an error occurs.

For More Information:

- On component access (Section 9.3)
- On the UFB function (Section 9.8.21)

- On the error-processing parameter (Section 9.7)

9.8.9. LINELIMIT Procedure

The LINELIMIT procedure stops execution of the program after a specified number of lines has been written into a TEXT file.

```
LINELIMIT( file_variable, n [[, ERROR := error-recovery]] );
```

`file_variable`

The name of the file variable associated with the TEXT file to which this limit applies.

`n`

A positive integer expression that indicates the number of lines that can be written to the file before execution terminates.

`error-recovery`

The action to be taken if an error occurs during execution of the routine.

The file can be in any mode before LINELIMIT is called; the file mode does not change after LINELIMIT has been executed.

VSI Pascal first uses environment-specific means to determine if there is a default line limit. If there is no environment-specific default, there is no default line limit. You can use a call to LINELIMIT to override the default.

After the number of lines written into the file has reached the line limit, program execution terminates unless the WRITELN procedure that exceeded the line limit includes the ERROR := CONTINUE parameter.

Consider the following example:

```
LINELIMIT( Debts, 100 );
```

Execution of the program terminates after 100 lines have been written into the text file Debts.

VSI Pascal determines the default line limit by translating an environment variable or logical name as a string of decimal digits. If the environment variable or logical name has not been defined, there is no default line limit. You can override the default by calling the LINELIMIT procedure.

For More Information:

- On TEXT files (Section 9.5)
- On the error-processing parameter (Section 9.7)

9.8.10. LOCATE Procedure

The LOCATE procedure positions a random-access file at a particular component so that the next PUT procedure can modify that component.

```
LOCATE( file_variable, component-number [[, ERROR := error-recovery]] );
```

`file_variable`

The name of the file variable associated with the file to be positioned.

`component-number`

A positive integer expression that indicates the relative component number of the component to be found.

`error-recovery`

The action to be taken if an error occurs during execution of the routine.

The file can be in any mode before LOCATE is called. The mode is set to generation after the procedure's execution.

The LOCATE procedure positions the file so that the next PUT procedure writes the contents of the file buffer into the selected component. After LOCATE has been performed, UFB returns TRUE and EOF is undefined. Because the LOCATE procedure does not perform an I/O operation, the value returned by the STATUS procedure is unaffected by LOCATE.

Consider the following example:

```
RESET( Books );  
New_Rec := Books^;  
GET( Books );
```

The LOCATE procedure positions the file `Accounts_Receivable` before relative component number 63. The call `UFB(Accounts_Receivable)` now returns TRUE and `EOF(Accounts_Receivable)` is undefined. The assignment statement loads the file buffer with the contents of file position 63. The PUT operation writes the file buffer into file component number 63. `UFB(Accounts_Receivable)` remains TRUE.

For More Information:

- On relative files (Section 9.1.2)
- On random access by relative component number (Section 9.3.2)
- On the UFB function (Section 9.8.21)
- On the error-processing parameter (Section 9.7)

9.8.11. OPEN Procedure

The OPEN procedure opens a file and allows you to specify file characteristics using either positional or nonpositional syntax.

```
1. OPEN( file_variable  
        , [[file_name]]  
        , [[history]]  
        , [[record_length]]  
        , [[access_method]]  
        , [[record_type]]  
        , [[carriage_control]]  
        , [[organization]]  
        , [[disposition]]
```

```

    , [[file_sharing]]
    , [[user_action]]
    , [[default_file_name]]
    , [[ERROR := error_recovery]] )

2. OPEN( FILE_VARIABLE := file_variable
        [[, FILE_NAME := file_name]]
        [[, HISTORY := history]]
        [[, RECORD_LENGTH := record_length]]
        [[, ACCESS_METHOD := access_method]]
        [[, RECORD_TYPE := record_type]]
        [[, CARRIAGE_CONTROL := carriage_control]]
        [[, ORGANIZATION := organization]]
        [[, DISPOSITION := disposition]]
        [[, SHARING := file_sharing]]
        [[, USER_ACTION := user_action]]
        [[, DEFAULT := default_file_name]]
        [[, ERROR := error_recovery]] ... )

```

`file_variable`

The name of the file variable associated with the file that VSI Pascal is to open.

`file_name`

A character-string expression containing the external file name. VSI Pascal determines the default file name according to the environment in which you are programming.

`history`

A value that indicates whether the file exists or if VSI Pascal must create the file. If you specify `OLD` and if VSI Pascal cannot find the file, an error occurs.

Other values are `READONLY` and `UNKNOWN`. If you specify `READONLY`, you can only read from the file; if you attempt to write to the file, an error occurs. If you specify `UNKNOWN`, VSI Pascal looks for an existing file but creates a new file if an existing file does not exist. If you specify `OLD` or `UNKNOWN` and if the attempt to open the file generates a file protection error, VSI Pascal tries again using `READONLY`.

`record_length`

A positive integer that specifies the maximum size in bytes for a line in a `TEXT` file or a file of type `FILE OF VARYING`. (Record length is equivalent to component length.) The default is 255 bytes. For all other types of files, VSI Pascal ignores this parameter.

If you do not specify a length for an existing file, VSI Pascal uses the length specified at the file's creation.

If you use `OPEN` to create a sequentially organized file with variable-length components, VSI Pascal records the maximum length of each component in the file only if you specify a value for the `record_type` field.

`access_method`

A value that specifies the component access method to use. The possible values include `SEQUENTIAL`, `DIRECT`, and `KEYED`. The `DIRECT` access method is equivalent to random access by relative component number. The `KEYED` access method is equivalent to random access by key.

`record_type`

A value that indicates the component format. (Record format and component format are equivalent.) The available values are `FIXED` (fixed-length components), `VARIABLE` (variable-length components), `STREAM` (stream component format with either carriage return, combination carriage return and line feed, or form-feed delimiters), `STREAM_CR` (stream component format with carriage-return delimiters), and `STREAM_LF` (stream component format with line-feed delimiters).

`carriage_control`

A value that indicates the carriage-control format for the file. The value `LIST` indicates single spacing between components. The values `CARRIAGE` and `FORTRAN` are equivalent and indicate that the first character of every output line is a carriage-control character. The values `NONE` and `NOCARRIAGE` indicate that the file has no carriage control.

`organization`

A value that specifies the file organization. If you are accessing an existing file, the specified organization must match the organization of the existing file; if it does not, an error occurs. The choices for this parameter are `SEQUENTIAL`, `RELATIVE`, and `INDEXED`.

`disposition`

A value that indicates what VSI Pascal should do with the file after you close the file. The dispositions are as follows:

Disposition	Description
<code>SAVE</code>	VSI Pascal retains the file.
<code>DELETE</code>	VSI Pascal deletes the file.
<code>PRINT</code>	VSI Pascal prints the file on a line printer and retains the file.
<code>PRINT_DELETE</code>	VSI Pascal prints the file on a line printer and then deletes the file.
<code>SUBMIT</code>	VSI Pascal submits to a queue or places the print job in a background process and retains the file.
<code>SUBMIT_DELETE</code>	VSI Pascal submits to a queue or places the print job in a background process and deletes the file.

`file_sharing`

A value that specifies whether another program can access the file while it is open. A value of `READONLY` indicates that other programs can read but not write to the file. A value of `READWRITE` indicates that a program can both read and write to the file while it is open. A value of `NONE` indicates that a program cannot read or write from the open file.

`default_file_name`

A string expression containing default file specification information. For instance, you can use this value to set a default directory specification.

`user_action`

A name of a user-written routine that VSI Pascal calls to open the file (instead of allowing VSI Pascal to open the file with the `OPEN` procedure). You can use a user-action routine to open the file using environment-specific capabilities of the I/O system underlying VSI Pascal.

`error_recovery`

The action to be taken if an error occurs during execution of the routine.

Using the OPEN procedure:

Before the OPEN procedure is called, the file is in undefined mode; its mode does not change after OPEN has been executed.

You cannot use OPEN on a file variable that is already open.

If you use INPUT or OUTPUT, VSI Pascal implicitly opens them just before their first use. VSI Pascal implicitly opens INPUT with a history of READONLY. If you choose, you can explicitly open INPUT or OUTPUT. To do this, call the OPEN procedure at any point in your compilation unit before you use the first I/O routine on that file.

Because the RESET, REWRITE, and EXTEND procedures implicitly open files, you need not always use the OPEN procedure. RESET, REWRITE, and EXTEND impose the same defaults as OPEN, except where noted (in the HISTORY parameter).

You must use the OPEN procedure to do the following:

- Create a TEXT file with fixed-length components
- Create a file with relative or indexed organization
- Open a file for direct or keyed access
- Specify a line length other than the default for a line in a TEXT file

Consider the following example:

```
PROGRAM Main( User_Guide );
VAR
User_Guide : TEXT;
{In the executable section:}
OPEN( User_Guide );
```

When the OPEN procedure is executed, the system first attempts to find an environment-specific translation for User_Guide. If no such translation happens, the file USER_GUIDE.DAT is created in the default device and directory on the local computer.

If User_Guide had not been specified as an external file in the program header, the OPEN procedure would have created an internal file. By default, the file is created with a record length of 255 bytes and components of variable length. The system then opens the file for sequential access.

Consider the following example:

```
OPEN( Journal_Accounts,
'JOURNAL.DAT',
HISTORY := UNKNOWN,
ACCESS_METHOD := KEYED,
ORGANIZATION := INDEXED );
```

If the file JOURNAL.DAT already exists, this procedure opens it; otherwise, VSI Pascal creates a new file named JOURNAL.DAT with the specified characteristics. If the file does exist, it must have the

same characteristics as those in the parameter list of the OPEN procedure. VSI Pascal opens the file with indexed organization for keyed access.

For More Information:

- On positional and nonpositional syntax (Section 6.3.8)
- On file organizations (Section 9.1)
- On component format (Section 9.2)
- On component access (Section 9.3)
- On carriage control (Section 9.5.1)
- On the error-processing parameter (Section 9.7)

9.8.12. PAGE Procedure

The PAGE procedure skips from the current page to the next page of a TEXT file.

```
PAGE( file_variable [[, ERROR := error-recovery]] );
```

`file_variable`

The name of the file variable associated with a TEXT file.

`error-recovery`

The action to be taken if an error occurs during execution of the routine.

The file must be in generation mode before the PAGE procedure is called; the mode does not change as a result of the procedure's execution.

Execution of the PAGE procedure clears the record buffer, if it contains data, by performing a WRITELN procedure, and then advances the output to a new page of the specified TEXT file. The next component written to the file begins on the first line of a new page. You can use this procedure only on TEXT files. If you specify a file of any other type, an error occurs.

The value of the page eject component that is output to the file depends on the carriage-control format for that file. When CARRIAGE or FORTRAN is enabled, the page eject record is equivalent to the carriage-control character '1'. When LIST, NOCARRIAGE, or NONE is enabled, the page eject record is a single form feed character.

Consider the following example:

```
PAGE( User_Guide );
```

This PAGE procedure causes a page eject record to be written in the text file User_Guide.

For More Information:

- On TEXT files (Section 9.5)
- On the error-processing parameter (Section 9.7)

9.8.13. PUT Procedure

The PUT procedure adds a new component to a file.

```
PUT( file_variable [[, ERROR := error-recovery]] );
```

file_variable

The name of the file variable associated with the output file.

error-recovery

The action to be taken if an error occurs during execution of the routine.

Before executing the first PUT procedure on a file opened for sequential access, you must execute an EXTEND, REWRITE, or TRUNCATE procedure to set the file to generation mode. EXTEND, REWRITE, and TRUNCATE set EOF to TRUE, thus preparing the file for output. ((TRUNCATE is legal only on files with sequential organization.)) If the file has indexed organization, the components to be written must be ordered by the primary key.

Before executing the first PUT statement on a file opened for direct access, you must execute an EXTEND, REWRITE, or LOCATE procedure to position the file.

The PUT procedure writes the value of the file buffer variable at the end of the specified sequential-file or direct-access file. You can use LOCATE to position a direct-access file and then use PUT to write the value of the file buffer variable at that position. After execution of the PUT procedure, the value of the file buffer variable becomes undefined (UFB returns TRUE). EOF remains TRUE and the file remains in generation mode.

You can call the PUT procedure for a keyed-access file, regardless of the file's mode (inspection, generation, or undefined). PUT causes the file buffer variable to be written to the file at the position indicated by the key. If the component has more than one key, the file buffer variable is inserted in each index at the appropriate location. After execution of PUT, a keyed-access file is in generation mode.

Consider the following example:

```
PROGRAM Book_File( INPUT, OUTPUT, Books );
TYPE
  My_String = PACKED ARRAY[1..40] OF CHAR;
  Book_Rec  = RECORD
    Author : My_String;
    Title  : My_String;
  END;
VAR
  New_Book : Book_Rec;
  Books    : FILE OF Book_Rec;
  n        : INTEGER;
{In the executable section:}
REWRITE( Books );
FOR n := 1 TO 10 DO
  BEGIN
    WITH New_Book DO
      BEGIN
        WRITE( 'Title:' );
        READLN( Title );
        WRITE( 'Author:' );
        READLN( Author );
```

```
    END;  
    Books^ := New_Book;  
    PUT( Books );  
    END;  
  
CLOSE( Books );
```

This program writes the first 10 components read from the terminal into the file `Books`. The component data items are typed at the terminal and assigned to the record variable `New_Book`. They consist of two 40-character strings denoting a book's author and title. The FOR loop accepts 10 values for `New_Book`, assigning each new record to the file buffer variable `Books^`. The PUT statement writes the value of `Books^` into the file for each input record.

For More Information:

- On component access (Section 9.3)
- On the UFB function (Section 9.8.21)
- On the error-processing parameter (Section 9.7)

9.8.14. READ Procedure

The READ procedure reads one or more file components into a variable.

```
READ( [[file_variable,]] {variable-identifier [[:radix-specifier]]}, ...  
      [[, ERROR := error-recovery]] );
```

`file_variable`

The name of the file variable associated with the input file. If you omit the name of the file, the default is `INPUT`.

`variable-identifier`

The name of the variable into which a file component will be read; multiple identifiers must be separated with commas.

`radix-specifier`

One of the format values `BIN`, `OCT`, or `HEX`. These values, when used on a variable identifier, will read the variable in binary, octal, or hexadecimal radix respectively. You can use a radix specifier only when reading from a `TEXT` file.

`error-recovery`

The action to be taken if an error occurs during execution of the routine.

The file must be in inspection mode before `READ` is called. The file remains in inspection mode after execution of a `READ` procedure.

The `READ` procedure for a nontext file performs an assignment statement, a `GET` procedure, and an `UNLOCK` procedure for each variable.

Consider the following example:

```
{This call to READ...}
```

```
READ( file_variable, variable-identifier );

{...is equivalent to the following code:}
variable-identifier := file_variable^;
GET( file_variable );

UNLOCK( file_variable );
```

The READ procedure reads from the file until it has found a value for each variable in the list. The first value read is assigned to the first variable in the list, the second value read is assigned to the second variable, and so on. The values and the variables must be of assignment-compatible types. Reading stops if an error occurs.

For a TEXT file, more than one component (character) can be read into a single variable. For example, many characters can be read into a string or converted into a numeric variable. The READ procedure repeats the assignment, GET, and UNLOCK process until it has read a sequence of characters that represent a legal value for the next variable in the parameter list. The procedure continues to read components from the file until it has assigned a value to each variable in the list.

After the last character has been read from a line of a TEXT file, EOLN returns TRUE and the file buffer variable contains a space. Unless you are reading into a character or string variable, a call to READ at this point skips over the end-of-line marker and positions the file at the beginning of the next line. If you are reading into a variable of type CHAR when EOLN returns TRUE, the space is read and assigned to the variable, and the file position advances. If you are reading into a string variable when EOLN becomes TRUE, the file position does not change. In the latter case, you should use the READLN procedure to advance the file position past the end-of-line marker.

Values from a TEXT file can be read into variables of integer, real, Boolean, character, string, and enumerated types. TEXT file values to be read into integer, real, Boolean, and enumerated variables can be preceded in the file by any number of spaces, tabs, and end-of-line markers. Values to be read into character variables, however, must not be separated because they are read and assigned character by character.

In a TEXT file, when VSI Pascal encounters a character that forms an object of a data type that does not match the data type of the parameter, reading stops. Consider the following example:

```
VAR
    i : INTEGER;
{In the executable section:}
READ( i );
```

If the object in the input file is 123ABC, the read stops at the character 'A', and i contains the value 123.

When reading constant identifiers of an enumerated type from a TEXT file, VSI Pascal reads all characters in the identifier, but recognizes only the first 31 characters. You need input only enough characters to make the identifier unique among the other constant identifiers of its type; text input data for enumerated types can consist of both lowercase and uppercase characters.

Boolean input data in TEXT files follow the same rules as other enumerated types. For example, the following character combinations, all of which could appear in a TEXT file, are equivalent: TRUE, True, T, t, tr.

When using a radix specifier, values from a TEXT file can be read into a variable of any type, except a type containing a file component. If the input stream does not provide sufficient data, the high-order bits are set to zero. When reading structured types, the input stream must account for any padding required for alignment.

You can use the READ procedure to read a sequence of characters from a TEXT file into a variable of type PACKED ARRAY OF CHAR. Successive characters from the file are assigned to components of the array, in order, until each component has been assigned a value. If any characters remain on the line after the array is full, the next READ procedure begins with the next character on that line. If the end of the line is encountered before the array is full, spaces are assigned to the remaining components.

You can also read TEXT file characters into a variable of types STRING or VARYING OF CHAR. Characters are assigned to a STRING or VARYING OF CHAR variable in a manner similar to that in which they are assigned to a packed array. However, if the end-of-line marker is encountered before the STRING or VARYING OF CHAR variable has been filled to its maximum length, the STRING or VARYING OF CHAR value is not padded with spaces. Instead, its current length is set equal to the number of characters that have been read into it. If you call the READ procedure with a parameter of type STRING or VARYING OF CHAR, and EOLN returns TRUE, no characters are read into the STRING or VARYING OF CHAR variable; its current length is set to zero.

Every nonempty TEXT file ends with an end-of-line marker and an end-of-file marker. Therefore, EOF never becomes TRUE when you are reading strings with the READ procedure. To test EOF when reading strings, use a READLN procedure to advance the file beyond the end-of-line marker.

Consider the following example:

```
READ( Temp, Age, Weight );
```

Assume that Temp, Age, and Weight are real variables, and that the following values have been entered at the terminal:

```
98.6 11 75
```

The variable Temp is assigned the value 98.6, Age is assigned the value 11.0, and Weight is assigned the value 75.0. You need not type all three values on the same line.

Consider the following example:

```
TYPE
  A_String = PACKED ARRAY[1..20] OF CHAR;
VAR
  Names      : TEXT;
  Pres, Veep : A_String;
{In the executable section:}
READ( Names, Pres, Veep );
```

This program fragment declares and reads the file Names, which contains the following character strings:

```
John F. Kennedy      Lyndon B. Johnson   Lyndon B. Johnson   <EOLN>
Hubert H. Humphrey  <EOLN>
Richard M. Nixon    Spiro T. Agnew      <EOLN>
```

The first call to the READ procedure sets Pres equal to the 20-character string 'John F. Kennedy#####' and Veep equal to 'Lyndon B. Johnson###'. The second call to the procedure assigns the value 'Lyndon B. Johnson###' to Pres and, after encountering the end-of-line marker, fills the array Veep with spaces. The file position does not advance to the beginning of the next line until a READLN is performed.

You can abbreviate values to be read into enumerated variables, as shown in the next example:

```
TYPE
  Color = ( Red, Fire_Engine_Green, Blue, Black );
VAR
```

```

    Light : Color;
{In the executable section:}
READ( Light );

```

In this example, if the letter R is read, the variable Light is assigned the value Red. However, if the letters Redx are read, an error occurs. If the letters Bl are read, an error also occurs because Bl is not unique. However, the letters Blu are unique and would be interpreted as the constant identifier Blue.

For More Information:

- On TEXT files (Section 9.5)
- On the error-processing parameter (Section 9.7)
- On specifying radices for output (Section 9.6.3 and Section 9.6.4)

9.8.15. READLN Procedure

The READLN procedure reads lines of data from a TEXT file.

```

READLN [( [[file_variable,]] {variable-identifier [[:radix-
specifier]]},...
        [, ERROR := error-recovery] )]];

```

file_variable

The name of the file variable associated with the TEXT file to be read. If you omit the name of the file, the default is INPUT.

variable-identifier

The name of the variable into which a value will be read; multiple identifiers must be separated with commas. If you do not specify any variable names, READLN skips a line in the specified file.

radix-specifier

One of the format values BIN, OCT, or HEX. These values, when used on a variable identifier, read the variable in binary, octal, or hexadecimal, respectively. You can use a radix-specifier only when reading from a TEXT file.

error-recovery

The action to be taken if an error occurs during execution of the routine.

The file must be in inspection mode before READLN is called; it remains in that mode after the procedure's execution.

The READLN procedure reads values from a TEXT file. After reading values for all the listed variables, the READLN procedure skips over any characters remaining on the current line and positions the file at the beginning of the next line. The values need not all be on a single line; READLN continues until values have been assigned to all the specified variables, even if this process results in the reading of several lines of the input file.

When applied to several variables, READLN performs the following sequence:

```

READ( file_variable, {variable-identifier},... );

```

```
READLN( file_variable );
```

EOLN returns TRUE after a READLN procedure only if the new line is empty.

You can use the READLN procedure to read integers, real numbers, Booleans, characters, strings, and constants of enumerated types. The values in the file must be separated as for the READ procedure. The rules governing the reading of values from text files are presented with the READ procedure.

Consider the following example:

```
TYPE
String = PACKED ARRAY[1..20] OF CHAR;
VAR
Names      : TEXT;
Pres, Veep : String;
{In the executable section:}
READLN( Names, Pres, Veep );
```

This program fragment declares and reads the file Names, which contains the following characters:

```
John F. Kennedy      Lyndon B. Johnson   Lyndon B. Johnson   <EOLN>
Hubert H. Humphrey  <EOLN>
Richard M. Nixon    Spiro T. Agnew      <EOLN>
<EOLN>
<EOF>
```

The READLN procedure reads the values 'John F. Kennedy ' for Pres and 'Lyndon B. Johnson ' for Veep. It then skips to the next line, ignoring the remaining characters on the first line. Subsequent execution of the procedure assigns the value 'Hubert H. Humphrey ' to Pres and the space detected as the end-of-line marker to Veep. A third call to the procedure reads 'Richard M. Nixon ' into Pres and 'Spiro T. Agnew ' into Veep. The procedure then skips past the end-of-line marker to the beginning of the next line. If you call READLN again, EOF becomes TRUE, and EOLN becomes undefined.

The READLN procedure is implemented as one or more READ calls followed by a READLN call. A STATUS call after a READLN procedure tests if the file was properly positioned, not whether the last READ was successful. To test if READLN successfully read data, replace the call to READLN with an explicit call to READ to read the line, then call STATUS to test the results of the READ, and finally call READLN to advance the file buffer variable for the next READLN.

For More Information:

- On the effect of delayed device access on tests of STATUS after a READLN procedure call (Section 9.5.3)
- On the READ procedure (Section 9.8.14)
- On the error-processing parameter (Section 9.7)
- On the radix specifiers (Section 9.6.3 and Section 9.6.4)

9.8.16. RESET Procedure

The RESET procedure puts a file into inspection mode, in which it can be read.

```
RESET( file_variable [[, file_name]] [[, ERROR := error-recovery]] );

file_variable
```

The name of the file variable associated with the input file.

```
file_name
```

String expression for the file name to be associated with the file_variable. If the file is already open, an error is signaled.

```
error-recovery
```

The action to be taken if an error occurs during execution of the routine.

The file can be in any mode before you call RESET; a call to RESET sets the file to inspection mode. If the file is an external file and is not already open, RESET opens it using the same defaults as the OPEN procedure. You cannot use RESET to create a file.

A call to RESET on a sequential file positions the file at the first component, and the file buffer variable contains the value of this component. If the file is not empty, EOF and UFB return FALSE and the first component is locked to prevent access by other processes. If the file is empty, EOF and UFB return TRUE. If the file does not exist, RESET does not create it, but returns an error at run time.

You must call RESET before reading any file with sequential organization except the predeclared file INPUT. The RESET procedure removes the end-of-file marker from any file connected to a terminal device (including INPUT), which allows reading from the file to continue. If you call RESET for the predeclared files OUTPUT or ERR, an error occurs.

A call to RESET on a relative file opened for direct access positions the file at its first existing component.

A call to RESET on an indexed file opened for keyed access positions the file at the first component relative to the primary key.

Consider the following example:

```
VAR
f : FILE OF INTEGER;
{In the executable section:}

OPEN( f , 'file.dat', ACCESS_METHOD := DIRECT );

RESET( f );
```

The OPEN call opens the file variable f for direct access. The RESET call positions the file at the first component and is necessary whether the file is new or old. After execution of the OPEN and RESET procedures, you can use the FIND procedure for direct access to the components of the file. For example:

```
RESET( Weights );
```

If the file variable Weights is already open, this procedure call prepares it for reading and assigns the value of the first file component to Weights^. If the file is not open, RESET causes VSI Pascal to open the file by default. If Weights is an external file, its file history will be OLD. If Weights does not exist, an error occurs.

For More Information:

- On component access (Section 9.3)

- On the default parameter values for OPEN (Section 9.8.11)
- On the error-processing parameter (Section 9.7)

9.8.17. RESETK Procedure

The RESETK procedure puts an indexed file into inspection mode, in which it can be read. RESETK can be applied only to indexed files opened for random access by key.

```
RESETK( file_variable, key-number[[, ERROR := error-recovery]] );
```

`file_variable`

The name of the file variable associated with the input file.

`key-number`

A nonnegative integer expression that indicates the key position.

`error-recovery`

The action to be taken if an error occurs during execution of the routine.

The file can be in any mode before RESETK is called to set the mode to inspection.

You assign a key number from 0 to 254 to each key field of a file component with the KEY attribute. The file is searched for the component with the lowest value in the specified key number. This component becomes the current component in the file and is locked. The value of the current component is copied into the file buffer; EOF and UFB are set to FALSE. If the component does not exist, EOF and UFB become TRUE. Note that a RESETK procedure on key number 0 is equivalent to a RESET procedure.

Consider the following example:

```
RESETK( Book_Index, 0 );
```

This procedure searches the file `Book_Index` for the component with the lowest value in the primary key. If this component exists, it becomes the current file component and is locked. The function calls `UFB(Book_Index)` and `EOF(Book_Index)` returns FALSE. If the procedure was unable to find the component, `UFB(Book_Index)` and `EOF(Book_Index)` return TRUE.

For More Information:

- On indexed files (Section 9.1.3)
- On random access by key (Section 9.3.2)
- On the UFB function (Section 9.8.21)
- On the error-processing parameter (Section 9.7)

9.8.18. REWRITE Procedure

The REWRITE procedure puts a file into generation mode in which it can be written.

```
REWRITE( file_variable [[, file_name]] [[, ERROR := error-recovery]] );
```

`file_variable`

The name of the file variable associated with the output file.

`file_name`

String expression for the file name to be associated with the `file_variable`. If the file is already open, an error is signaled.

`error-recovery`

The action to be taken if an error occurs during execution of the routine.

The file can be in any mode before REWRITE is called to set the mode to generation. If the file variable has not been opened, REWRITE creates and opens it using the same defaults as the OPEN procedure.

The REWRITE procedure truncates sequential files to length zero and sets EOF and UFB to TRUE. You can then write new components into the file with the PUT, WRITE, and WRITELN procedures (WRITELN is defined only for text files). After the file is open, successive calls to REWRITE truncate the existing file to a length of zero.

To update an existing file with sequential organization, you must either use the EXTEND procedure, use the TRUNCATE procedure, or copy the contents to another file, specifying new values for the components you need to update.

When applied to a file with relative or indexed organization, REWRITE deletes the contents of the file and sets the file position to the beginning of an empty file.

Consider the following example:

```
REWRITE( Storms );
```

If the file variable Storms is already open, this REWRITE procedure prepares the file for writing, clears it of old data, and sets the file position to the beginning of the file. If Storms is not open, a new version is created with the same defaults as for the OPEN procedure.

Consider the following example:

```
VAR
Ratings : FILE OF INTEGER;
{In the executable section:}

OPEN( Ratings, 'cars.dat', HISTORY := OLD, RECORD_TYPE := FIXED );

REWRITE( Ratings );
```

The OPEN procedure opens the file variable Ratings, which is associated with the file cars.dat. The REWRITE procedure discards the current contents of the file f and sets the file position to the beginning of the file. After execution of this procedure, EOF(Ratings) returns TRUE.

For More Information:

- On component access (Section 9.3)
- On the default parameters for OPEN (Section 9.8.11)
- On the error-processing parameter (Section 9.7)

9.8.19. STATUS Function

The STATUS function indicates the status of a file following the last operation performed on it. The LOCATE procedure does not perform an operation, but sets internal data in the run-time library for use by future operations. Therefore, this procedure does not affect the result of the STATUS function.

```
STATUS(file_variable )
```

```
file_variable
```

The name of the file variable associated with the file to be tested.

The file can be in any mode before STATUS is called; unless an error occurs, STATUS does not change the file mode upon execution.

The STATUS function returns one of the following integer codes that indicate the previous operation's effect on the file:

Code	Description
0	Successful operation
-1	End-of-file encountered
Positive integer ¹	Error encountered

¹The actual number is environment-specific and indicates the exact error that occurred.

A test by the STATUS function on a TEXT file causes delayed device access to occur, which fills the file buffer with the next file component. Therefore, EOF, EOLN, UFB, and STATUS never return an error code following a successful STATUS function call.

Consider the following example:

```
RESET( File1, ERROR := CONTINUE );
IF STATUS( File1 ) > 0 THEN WRITELN( 'Cannot access first record' )
ELSE
IF STATUS( File1 ) < 0 THEN WRITELN( 'File is empty' )
ELSE READ( File1 );
```

If the RESET procedure encounters either an error condition or an end-of-file, an appropriate error message is displayed. If the STATUS function indicates that the RESET procedure was successful, the first record is read from the file.

For More Information:

- On TEXT files (Section 9.5)
- On the error-processing parameter (Section 9.7)

- On delayed device access (Section 9.5.3)
- On status code translations (*VSI Pascal for OpenVMS User Manual*)

9.8.20. TRUNCATE Procedure

The TRUNCATE procedure indicates that the current file component and all components following it are to be deleted. You can only use TRUNCATE on a file that has sequential organization.

```
TRUNCATE( file_variable [, ERROR := error-recovery] );
```

`file_variable`

The name of the file variable associated with the file to be truncated.

`error-recovery`

The action to be taken if an error occurs during execution of the routine.

The file must be in inspection mode before TRUNCATE is called. After the procedure has been executed, the mode is set to generation so that you can write to the file.

After the appropriate components have been deleted, the file remains positioned at the new end-of-file, but the file buffer itself is undefined. Thus, EOF and UFB are both set to TRUE.

Consider the following example:

```
TRUNCATE( Master_File );
```

This procedure deletes components from `Master_File`, beginning with the current component and continuing until EOF returns TRUE. When the operation is complete, EOF(`Master_File`) and UFB(`Master_File`) are TRUE, and new data can be written at the end of `Master_File`.

For More Information:

- On sequential files (Section 9.1.1)
- On the error-processing parameter (Section 9.7)

9.8.21. UFB Function

The UFB (Undefined File Buffer) function returns a Boolean value to indicate whether the last file operation gave the file buffer an undefined status.

```
UFB( file_variable )
```

`file_variable`

The name of the file variable associated with the file whose buffer is being tested.

The file can be in any mode before UFB is called, the execution of UFB does not change the file mode.

UFB tests the effect of the last I/O operation on the file. UFB returns FALSE if a successful GET, FIND, FINDK, RESET, or RESETK operation has filled the file buffer. GET, FIND, FINDK, RESET, and RESETK procedure calls that do not fill the file buffer due to the data not being present in the file set

UFB to TRUE. GET, FIND, FINDK, RESET, and RESETK procedure calls that could not examine the file leave UFB in an unknown state. You must use the STATUS builtin to determine if the GET, FIND, FINDK, RESET, and RESETK procedure calls were able to examine the contents of the file. UFB also returns TRUE after DELETE, EXTEND, LOCATE, PUT, REWRITE, TRUNCATE, and UPDATE procedures have left the contents of the file buffer unknown.

Assigning a new value to the file buffer with an assignment statement does not change the value of UFB. Consider the following example:

```
FIND( Supplies, December );
IF NOT UFB( Supplies ) THEN
Inventory := Inventory - Supplies^;
```

If the variable December has a value of 12, the FIND procedure attempts to find the twelfth component of the file Supplies. If the FIND procedure is successful, Supplies^ assumes the value of this component and UFB(Supplies) is FALSE. If, however, the FIND procedure is unable to find the twelfth component of the file, UFB(Supplies) returns TRUE. In this example, the value of Supplies^ is subtracted from the value of Inventory only if the FIND procedure is successful.

9.8.22. UNLOCK Procedure

The UNLOCK procedure releases the current file component for access by other processes.

```
UNLOCK( file_variable [[, ERROR := error-recovery]] );

file_variable
```

The name of the file variable associated with the file whose component is to be unlocked.

error-recovery

The action to be taken if an error occurs during execution of the routine.

The file must be in inspection mode before UNLOCK is called; it remains in inspection mode after UNLOCK has executed.

If the component at which the file pointer is positioned has been locked, the UNLOCK procedure releases it.

Consider the following example:

```
UNLOCK( Sales_File );
```

The UNLOCK procedure releases the contents of the current component.

For More Information:

On the error-processing parameter (Section 9.7)

9.8.23. UPDATE Procedure

The UPDATE procedure writes the contents of the file buffer into the current component.

```
UPDATE( file_variable[[, ERROR := error-recovery]] );

file_variable
```

The name of the file variable associated with the file whose component is to be updated.

`error-recovery`

The action to be taken if an error occurs during execution of the routine.

The file must be in inspection mode before UPDATE is called; it remains in that mode after the procedure's execution.

The UPDATE procedure is legal for files that have been opened for random access (direct or keyed). The current component must already have been locked by a successful FIND, FINDK, GET, RESET, or RESETK procedure before the contents of the file buffer can be rewritten into it. After the update has taken place, the component is unlocked and UFB returns TRUE.

Consider the following example:

```
UPDATE( October_Sales );
```

This procedure writes the file buffer contents (October_Sales^) back into the current file component October_Sales. The component is then unlocked and UFB(October_Sales) returns TRUE.

For More Information:

- On component access (Section 9.3)
- On the error-processing parameter (Section 9.7)

9.8.24. WRITE Procedure

The WRITE procedure assigns data to an output file.

```
WRITE([[file_variable, ]]{expression},... [[, ERROR := error-recovery]] )  
  
file_variable
```

The name of the file variable associated with the output file. If you omit the name of the file, the default is OUTPUT.

`expression`

An expression whose value is to be written; multiple output values must be separated with commas. An output value must have the same type as the file components; however, values written to a TEXT file can also be expressions of any ordinal, real, or string type. You can specify the output format of the expression as described in Section 9.6.

`error-recovery`

The action to be taken if an error occurs during execution of the routine.

The file (unless it is a random-access by key file) must be in generation mode before WRITE is called; it remains in that mode after WRITE has executed.

By definition, a WRITE statement to a nontext file performs an assignment to the file buffer variable and a PUT statement for each output value. For nontext files, the types of the output values must be assignment compatible with the component type of the file. For example:

```
WRITE( file_variable, expression );
```

This procedure call is similar to the following example:

```
file_variable^ := expression;  
PUT( file_variable );
```

For TEXT files, the WRITE procedure converts the value of each expression to a sequence of characters. It repeats the assignment and PUT process until all the values have been written to the file.

Consider the following example:

```
TYPE  
  String = PACKED ARRAY[1..20] OF CHAR;  
VAR  
  Names : FILE OF String;  
  Pres  : String;  
{In the executable section:}  
WRITE (Names, 'Millard Fillmore   ', Pres);
```

This example writes two components in the file Names. The first is the 20-character string constant 'Millard Fillmore####'. The second is the value of the string variable Pres.

For More Information:

- On TEXT files (Section 9.5)
- On component format (Section 9.2)
- On output format (Section 9.6)
- On prompting from the terminal (Section 9.5.2)
- On the error-processing parameter (Section 9.7)

9.8.25. WRITELN Procedure

The WRITELN procedure writes a line of data to a text file.

```
WRITELN [( ( [[file_variable,]] {expression, ...  
            [, ERROR := error-recovery]] )]
```

file_variable

The name of the file variable associated with the text file to be written. If you omit the name of the file, the default is OUTPUT.

expression

An expression whose value is to be written; multiple output values must be separated by commas. The expressions can be of any ordinal, real, or string type and are written with a default field width, which you can override as described in Section 9.6.

error-recovery

The action to be taken if an error occurs during execution of the routine.

The file must be in generation mode before `WRITELN` is called; it remains in that mode after `WRITELN` has been executed.

The `WRITELN` procedure writes the specified values into the `TEXT` file, inserts an end-of-line marker after the end of the current line, and then positions the file at the beginning of the next line. When applied to several expressions, `WRITELN` performs the following sequence:

```
WRITE (file_variable, {expression},...);
WRITELN (file_variable);
```

Consider the following example:

```
WRITELN( User_Guide, 'This manual describes how to interact');
```

This procedure writes the string to the `TEXT` file `User_Guide`, follows it with an end-of-line marker, and skips to the next line.

You can specify a carriage-control character as the first item in an output line. When you use carriage-control characters, make sure that the file is open with either the `CARRIAGE` or `FORTTRAN` option. Consider the following example:

```
WRITELN( Tree, ' ', String1, String2 );
```

The first item in the list is a space character. The space indicates that the values of `String1` and `String2` are printed on a new line when the file is written to a terminal, line printer, or similar carriage-control device.

If you specify a carriage format but use an invalid carriage-control character, the first character in the line is ignored and the output appears with the first character truncated. Consider the following example:

```
TYPE
  A_String = PACKED ARRAY[1..25] OF CHAR;
VAR
  New_Hires : TEXT;
  n         : INTEGER;
  New_Rec   : RECORD
    Id      : INTEGER;
    Name,
    Address : A_String;
  END;
{In the executable section:}
OPEN( New_Hires, 'new_hires.dat', CARRIAGE_CONTROL := FORTTRAN );
REWRITE( New_Hires );
WITH New_Rec DO
  BEGIN
    WRITELN( New_Hires, '1New hire # ', ID:1, ' is ', Name );
    WRITELN( New_Hires, ' ', Name, ' lives at:' );
    WRITELN( New_Hires, ' ' );
    WRITELN( New_Hires, ' ', Address );
  END;
```

In this example, four lines are written to the `TEXT` file `New_Hires`. The output starts at the top of a new page, as directed by the carriage-control character '1', and appears in the following format:

```
New hire # 73 is Irving Washington
Irving Washington      lives at:

22 Chestnut St, Seattle
```

For More Information:

- On TEXT files (Section 9.5)
- On carriage-control characters in new files (Section 9.8.11)
- On the error-processing parameter (Section 9.7)
- On formatting output (Section 9.6)

Chapter 10. Attributes

An **attribute** is an identifier that directs the VSI Pascal compiler to change its behavior in some way. This chapter discusses the following information about attributes:

- Attribute syntax (Section 10.1)
- Attributes (Section 10.2)
- Attribute classes (Section 10.3)

When an attribute is not explicitly stated, the compiler follows the default rules to assign properties to program elements. However, using attributes to override the defaults allows additional control over the properties of data items, routines, and compilation units.

For convenience in description, the attributes are grouped in **attribute classes**. All attributes in a given class share common characteristics (sometimes there is only one attribute to a class).

Table 10.7 presents the attributes in each class. To save you the time of scrolling through all the attributes, you can click on the Table Of Contents entry for the desired attribute.

For More Information:

- For information on environment-specific issues about attributes (Appendix A)

10.1. Attribute Syntax

The following syntax applies to all VSI Pascal attributes:

```
{ constant-expression }  
[ { identifier1 [[ ( { identifier2 } , ... ) ] ] } , ... ]  
{  
}
```

identifier1

The name of the attribute.

constant-expression

A compile-time integer expression, represented in this chapter by *n*, that qualifies several of the VSI Pascal attributes.

identifier2

The name of an option available in one of the following instances:

- With the CHECK, OPTIMIZE, or KEY attributes.
- With COMMON and PSECT attributes, indicating the name of a storage area.
- With the GLOBAL, EXTERNAL, WEAK_GLOBAL, and WEAK_EXTERNAL attributes, indicating an external name. If entered as a quoted string, passed to the linker with case unmodified.

A list of attributes can appear anywhere in the VAR, TYPE, and CONST declaration sections, and anywhere in a program that a type, a type identifier, or the heading of a routine or compilation unit is legal. However, only one attribute from a particular class can appear in a given attribute list. The use

of attribute lists is shown in examples throughout this chapter. The names of attributes, when used in a suitable context, cannot conflict with other identifiers with the same name in the program.

Syntactically, an attribute list can appear before a VAR, TYPE, and CONST section in the declaration section. In this case, the attributes would apply to all elements in that particular section. However, VSI Pascal only allows you to use the ALIGN, ENUMERATION_SIZE, and HIDDEN attribute in this way.

Some attributes require a special form of constant expression called a **name string**. The syntax of a name string differs from that of other strings in VSI Pascal only in that a name string cannot use the extended-string syntax.

Every program element must be associated with one property for each applicable attribute class. The VSI Pascal compiler automatically supplies the defaults for the unspecified classes at the time of the element's declaration. In some classes, as described in the following sections, the default property is not available through an explicit attribute.

Attributes can be associated with data items in the following ways:

- By appearing in a type definition in a TYPE section; the item is later declared to be of that type.
- By appearing in the declaration of an item preceding its type.
- By appearing before the current declaration section.

Note

In VSI Pascal, the presence of constant expressions and attribute lists leads to a minor ambiguity in the language syntax. If the compiler finds a left bracket ([) symbol when it expects to find a type or type identifier, it always assumes that the bracket indicates the beginning of an attribute list. The ambiguity arises because the left bracket could also represent the beginning of a set constructor that denotes the low bound of a subrange type. If the latter case is in fact what you intend, enclose the set constructor in parentheses; the compiler will interpret the expression correctly. For example:

```
TYPE X = ([1] <= [2])..True;
```

When a type definition includes a list of attributes, the type has only those attributes specified. The compiler does not supply the defaults for the unspecified classes until a data item is declared to be of that type. Two rules govern the use of attributes in a TYPE section:

- The attributes of the type can neither conflict with nor duplicate any attributes explicitly stated in the data item's declaration.
- The type cannot be used anywhere where its accompanying attributes are illegal.

The following example shows both legal and illegal use of attributes in type definitions:

```
TYPE
  A = [GLOBAL] INTEGER;
  B = [UNALIGNED] INTEGER;
VAR
  A1 : [GLOBAL] A;           { Illegal; duplicates GLOBAL
                             attribute of type A }
  A2 : [EXTERNAL] A;        { Illegal; conflicts with
                             GLOBAL attribute of type A }
  B1 : ^B;                  { Illegal; pointer base type
                             cannot be UNALIGNED }
```

```
C : A;           { Legal }
```

The first three variable declarations are illegal for the reasons shown in the comments. The declaration of `C` is legal; `C` is declared as a global `INTEGER` because of the characteristics of its type. The compiler supplies defaults for all other classes applicable to the variable `C`.

Attributes associated with data items usually modify type compatibility rules. These modifications are explained in the sections describing individual attributes.

For More Information:

- On extended-string syntax (Section 2.6)
- On program elements and attribute properties (Section 10.3)
- On type compatibility (Section 2.10)

10.2. Attributes

The following sections describe each attribute in alphabetical order.

10.2.1. ALIGN

The `ALIGN` attribute controls the default alignment, packing, and allocation rules in a compilation unit, `TYPE` section, or `VAR` section. For example:

```
[ALIGN (keyword) ]
```

The `ALIGN` attribute takes a single keyword parameter that has the same name and meaning as the keywords for the `/ALIGN` qualifier. However, specifying the `ALIGN` attribute overrides any value that you previously specified using the `/ALIGN` qualifier.

The `ALIGN` attribute can appear at the beginning of the compilation unit and before a `TYPE` or `VAR` section. When used before a `TYPE` or `VAR` section, the default alignment, packing, and allocation rules are modified *only* for the duration of the `TYPE` or `VAR` section. For example:

```
[ALIGN (VAX) ]
TYPE
    vax_type = Array [1..10] of char;

TYPE
    alpha_type = Array [1..10] of char;
```

Usage and Default Information:

Table 10.1 lists the keywords for the `ALIGN` attribute. See Section A.2.7 for a complete description of the alignment rules for each platform and Section A.2.4 for a complete description of the allocated sizes for objects for each platform.

Table 10.1. ALIGN Attribute Keywords

Keyword	Action	Default on System
NATURAL ¹	Uses natural alignment when positioning record fields or array components. Natural	VSI OpenVMS I64 and VSI OpenVMS Alpha

Keyword	Action	Default on System
	alignment is when a field or component is positioned on a boundary based on its size. For example, 32-bit integers would be aligned on the nearest 32-bit boundary.	
VAX	Uses byte alignment when positioning record fields or array components. Field or components larger than 32 bits are positioned on the nearest byte boundary.	OpenVMS VAX

¹Previous versions of VSI Pascal used ALPHA_AXP for this keyword. The NATURAL keyword is now the recommended spelling for the same behavior. The ALPHA_AXP keyword will continue to be recognized for compatibility with old source files.

On OpenVMS VAX systems, when you specify a value of NATURAL, automatic variables are aligned on longword boundaries instead of quadword boundaries. This occurs because the largest allowable alignment for the stack is longword alignment.

For More Information:

- On allocation sizes of objects (Section A.2.4)
- On storage allocation (Section A.2.5)

10.2.2. ALIGNED

The ALIGNED attribute indicates the object is to be aligned on a specific memory boundary.

```
ALIGNED [[ ( n ) ]]
```

An aligned object is aligned on the memory boundary indicated by n. The constant expression n indicates that the address of the object must end in at least n zeros. ALIGNED(0) specifies byte alignment, ALIGNED(1) specifies word alignment, ALIGNED(2) specifies longword alignment, ALIGNED(3) specifies quadword alignment, ALIGNED(4) specifies octaword alignment, and ALIGNED(9) specifies alignment on a 512-byte boundary.

Usage and Default Information:

- The default alignment of an object depends on its size.
- The constant expression n must denote an integer. If you omit n, the default is 0, indicating byte alignment.
- If the expression provided to the ALIGNED attribute is greater than the largest supported alignment on the target platform, the compiler will print a warning message and default to the largest supported value. (Note that ALIGNED(13) is the largest alignment allowed on VSI OpenVMS I64 and VSI OpenVMS Alpha systems and ALIGNED(9) is the largest alignment allowed on OpenVMS VAX systems).
- An automatic variable cannot have alignment greater than an octaword on VSI OpenVMS I64 systems, or a quadword on VSI OpenVMS Alpha systems, or a longword on OpenVMS VAX systems.
- The minimum alignment for an object of a structured type is the greatest alignment specified for any of its components.

- Alignment attributes are illegal on nonstatic types, components of files, and on VARYING OF CHAR strings.
- The alignment of a formal VAR parameter cannot be greater than the alignment of a corresponding actual parameter, either by default or by means of an alignment attribute. In an array variable passed to a conformant formal parameter, alignment and size attributes are illegal on all dimensions of the actual parameter, except the first, that correspond to the dimensions of the formal parameter.
- On OpenVMS I64 systems, the base type of a pointer variable passed to the NEW procedure cannot have alignment greater than an octaword. On OpenVMS Alpha and OpenVMS VAX systems, the base type of a pointer variable passed to the NEW procedure cannot have alignment greater than a quadword.
- If the base type of a pointer variable has a specified alignment, then the base type of a pointer expression assigned to it must have an alignment equal to that of the variable.
- Pointer types are structurally compatible only if their base types have identical alignment.

The following is an example of the ALIGNED attribute:

```
VAR
  Free_Buffers : [ ALIGNED( 1 ), WORD] -2**15..2**15-1;
  {In the executable section:}
  IF ADD_INTERLOCKED( -1, Free_Buffers ) <= 0 THEN
  {Statement:}
```

The predeclared function ADD_INTERLOCKED requires that the second parameter passed to it have word alignment and an allocation size of one word. In this example, the variable Free_Buffers is declared with alignment and size attributes to meet these restrictions.

For More Information:

- On automatic and size attribute classes (Section 10.3)
- On static and nonstatic types (Section 2.9)
- On default alignments (*VSI Pascal for OpenVMS User Manual*)

10.2.3. ASYNCHRONOUS

The ASYNCHRONOUS attribute indicates that a routine can be called asynchronously to the main program execution. For example, AST routines or condition handlers are asynchronous routines because they are called without an explicit procedure call in your program. Routines with the ASYNCHRONOUS attribute can only access local variables and up-level VOLATILE variables. Additionally, asynchronous routines can only call other asynchronous routines.

Usage and Default Information:

- This attribute can be applied to routines and to routine parameters declared in external routines.
- In the absence of the ASYNCHRONOUS attribute, the compiler assumes that the routine can be activated only by actual calls within the program.
- All predeclared routines are asynchronous by default.

- Any routines called from within the block of an asynchronous routine must be local to the asynchronous routine or must themselves be asynchronous, either by default or by an explicit attribute.
- All nonlocal variables accessed from within the block of an asynchronous routine must be declared VOLATILE or READONLY.
- If a formal routine parameter is asynchronous, all actual parameters passed to it must also be asynchronous.
- An asynchronous routine can be passed as an actual parameter to a formal routine parameter that does not have this attribute.

Consider the following example:

```
PROCEDURE Do_Something;
  VAR
    i : [VOLATILE] INTEGER;
    j : INTEGER
  [ASYNCHRONOUS] FUNCTION Handler {Two array parameters} : BOOLEAN;
  BEGIN
    i := i + 1;
    {Remaining function body...}
  {In the executable section of the procedure:}
  ESTABLISH( Handler );
```

This example shows the declaration of the asynchronous function Handler. The executable section of Handler cannot access variables declared in the enclosing block of the procedure Do_Something unless those variables are declared VOLATILE. Handler can access the variable i, which has the VOLATILE attribute, but cannot access the variable j.

For More Information:

- On the VOLATILE attribute (Section 10.2.42)
- On the READONLY attribute (Section 10.2.34)
- On the ESTABLISH procedure (Section 8.30)

10.2.4. AT

The AT attribute specifies that VSI Pascal allocates no storage for the object (storage has already been allocated) and that it resides at the exact, specified address.

```
AT ( n )
```

The exact address is specified by the constant expression n. Variables representing machine-dependent entities are frequently given the AT attribute.

Usage and Default Information:

- A variable having the AT, COMMON, or PSECT attribute is implicitly static.
- AT cannot be applied to routines or to compilation units.
- AT cannot be applied to variables of nonstatic types.

For More Information:

- On default allocation for variables declared in the outermost block of a program or in nested blocks (Section 10.2.5)
- On default allocation for variables declared in the outermost block of a module (Section 10.2.36)
- On static and nonstatic types (Section 2.9)

10.2.5. AUTOMATIC

The `AUTOMATIC` attribute specifies that storage for the variable be allocated each time the program enters the routine in which the variable is declared. The storage is deallocated each time the program exits from that routine. An automatic variable exists as long as the declaring routine remains active.

Usage and Default Information:

- By default, variables declared in nested blocks are automatic.
- By default, variables declared at the outermost level of a program are automatic, though for efficiency they can be made static.
- By default, the control part of the nonstatic types and the pointer part of variables of nonstatic types follow the same rules as regular variables: they are static or automatic depending on the location of the declaration and the usage of the data.
- Global and external variables are implicitly static. Thus, they conflict with the `AUTOMATIC` attribute.
- Program-level variables with the `AUTOMATIC` attribute are not recorded in environment files.
- `AUTOMATIC` cannot be applied to routines and compilation units.
- `AUTOMATIC` cannot be applied to nonstatic types.

For More Information:

- On an example of the `STATIC` attribute (Section 10.2.36)
- On the `GLOBAL` attribute (Section 10.2.17)
- On the `EXTERNAL` attribute (Section 10.2.15)
- On static and nonstatic types (Section 2.9)

10.2.6. BIT

The `BIT` attribute specifies the amount of storage in bits to be received by the object.

```
BIT[[ ( n ) ]]
```

The optional constant `n` indicates the number of bit storage units.

Usage and Default Information:

The following size attribute restrictions apply to `BIT`, `BYTE`, `LONG`, `WORD`, `QUAD` and `OCTA`.

- The default size of an object depends on its type.
- The constant expression *n* must denote a positive integer. If you omit *n*, the default value is 1.
- Objects of floating-point or pointer types must have a size equal to their allocation size.
- Ordinal types cannot exceed their maximum size, which is determined by the platform and the value of the data switch for the compile command.
- The amount of storage described must be large enough to contain an object of the specified type; otherwise, a compile-time error occurs.
- Assignment to variables with a size attribute are zero-extended (if necessary) and all bits are written.
- When you fetch from variables with a size attribute, the compiler need only reference sufficient bits to access the legal value of the type. The contents of a variable are undefined if it does not contain a zero-extended legal value of the variable's type.
- A size attribute is illegal on a conformant parameter, on a component of a VARYING string, on an object of a structured type having a file component, or on a nonstatic type. In an array variable passed to a conformant formal parameter, size and alignment attributes are illegal on all dimensions of the actual parameter, except the first, that correspond to the dimensions of the formal parameter.
- Two variables of the same type that have different allocation sizes are assignment compatible but are not structurally compatible.

For More Information:

- On alignment attributes (Section 10.3)
- On type compatibility (Section 2.10)
- On size attributes and return values of size functions (Section 8.81)
- On allocation sizes of objects (Section A.2.4)

10.2.7. BYTE

The BYTE attribute specifies the amount of storage in bytes to be received by the object.

```
BYTE [[ ( n ) ]]
```

The optional constant *n* indicates the number of byte storage units.

For More Information:

- On allocation sizes of objects (Section A.2.4)
- On size allocation restriction (Section 10.2.6)

10.2.8. CHECK

The CHECK attribute specifies error-checking options that are to be enabled during program execution.

```
CHECK [[ ( {identifier}, ... ) ]]
```

An identifier specifies an option to be enabled. If you omit the list of options, all available positive options are enabled.

Table 10.2 presents the options that allow you to choose which aspects of a program should be checked. The negations of an option disable checking for that option.

Table 10.2. Summary of Checking Options

Option	Action	Negation
ALL	Enables all forms of checking.	NONE
BOUNDS	Verifies that an index expression is within the bounds of an array's index type and that character-string sizes are compatible with the operations being performed and that schema types are compatible.	NOBOUNDS
CASE_SELECTORS	Verifies that the value of a case selector is contained in the corresponding case label list.	NOCASE_SELECTORS
DECLARATIONS	Verifies that schema definitions yield valid types and that uses of GOTO from one block to an enclosing block are correct.	NODECLARATIONS
OVERFLOW	Verifies that the result of an integer computation does not exceed the machine representation.	NOOVERFLOW
POINTERS	Verifies that the value of a pointer variable is not NIL.	NOPOINTERS
SUBRANGE	Verifies that values assigned to variables of subrange types are within the subrange; verifies that a set expression is assignment compatible with a set variable.	NOSUBRANGE

Usage and Default Information:

- This attribute can be applied to routines and compilation units.
- If not specified on a routine, or compilation unit, the CHECK qualifier or switch value is used as the default. If you specify options for CHECK, VSI Pascal enables only the specified options. Consider the following example:

```
[CHECK]           { is equivalent to }   [CHECK( ALL )]
[CHECK( option )] { is equivalent to }   [CHECK( NONE, option )]
```

Consider the following example:

```
PROGRAM Check_Features;

[CHECK( POINTERS, CASE_SELECTORS )] PROCEDURE Linked_List
    (VAR Client : Info_Rec);    {Body of the procedure...}

[CHECK( OVERFLOW )] FUNCTION Integer_Compute
    (VAR Int1, Int2, Int3 : INTEGER) : INTEGER;
    {Body of the function...}
```

```
PROCEDURE Bounds_Check (VAR A_String : VARYING[30] OF CHAR;  
                        VAR Char_Array : ARRAY[1..25] OF CHAR;  
                        VAR Half_Alpha : 'A'..'M'); {Body...}
```

For the routines `Linked_List` and `Integer_Compute`, VSI Pascal enables only the specified options. The procedure `Bounds_Check` has only the `BOUNDS`, and `DECLARATIONS` options enabled by default (unless you use a compilation switch to override the default).

For More Information:

On type compatibility (Section 2.10)

10.2.9. CLASS_A

The `CLASS_A` attribute causes a formal parameter to be passed by an array descriptor that describes contiguous arrays of atomic data types or contiguous arrays of fixed-length strings. This attribute is illegal on parameters of schema types.

Consider the following example:

```
PROCEDURE Test2( P3 : [CLASS_S] PACKED ARRAY[L..U : INTEGER] OF CHAR;  
                P4 : [CLASS_A] ARRAY[L2..U2 : INTEGER] OF REAL); EXTERN;
```

This example defines a procedure `Test2`, which has two parameters. The first parameter, `P3`, is passed by descriptor of `CLASS_S`. The second parameter, `P4`, is passed by a `CLASS_A` descriptor.

For More Information:

- On VSI Pascal parameter defaults (Section 6.3)
- On `CLASS_A` descriptors (*VSI OpenVMS Calling Standard*)

10.2.10. CLASS_NCA

The `CLASS_NCA` attribute causes a formal parameter to be passed by a noncontiguous array descriptor. This attribute is illegal on parameters of schema types.

For More Information:

- On VSI Pascal parameter defaults (Section 6.3)
- On `CLASS_NCA` descriptors (*VSI OpenVMS Calling Standard*)

10.2.11. CLASS_S

The `CLASS_S` attribute causes a formal parameter to be passed by a single descriptor form that is used for scalar data and fixed-length strings. On VSI OpenVMS systems, this attribute allows routines written in VSI Pascal to accept actual parameters from languages such as FORTRAN that generate `CLASS_S` descriptors.

Usage and Default Information:

- In order to pass a `CLASS_S` string descriptor, you must use a packed conformant array of characters.

- This attribute is illegal on parameters of schema types.
- When the packed conformant array is passed by CLASS_S descriptor, the lower bound of the conformant schema is always 1 and the upper bound of the conformant schema is the length of the string being passed.

Consider the following example:

```
PROCEDURE Print_String( String_Parm :  
    [CLASS_S] PACKED ARRAY[LOW..HIGH : INTEGER] OF CHAR );  
BEGIN  
    WRITELN( 'The CLASS_S string is', String_Parm );  
    WRITELN( 'The lowerbound is', Low );  
    WRITELN( 'The upperbound is', High );  
END;
```

The previous example defines the procedure `Print_String`, which has one parameter. The `CLASS_S` attribute on the VSI Pascal routine specifies that the calling routine passes the `String_Parm` parameter by a `CLASS_S` descriptor.

For More Information:

- On VSI Pascal parameter defaults (Section 6.3)
- On mixed-language programming (*VSI Pascal for OpenVMS User Manual*)
- On CLASS_A and CLASS_S descriptors (*VSI OpenVMS Calling Standard*)

10.2.12. COMMON

The `COMMON` attribute specifies that storage for a variable be allocated in an overlaid program section called a common block.

```
[ COMMON [[ ( { identifier } ) ] ] ]  
  
identifier
```

An identifier that indicates the name of the common block. If you omit the identifier, the name of the variable is used as the name of the common block.

This attribute allows you to share variables with other VSI languages, such as VSI Fortran.

Usage and Default Information:

- A variable having the `AT`, `COMMON`, or `PSECT` attribute is implicitly static.
- The `COMMON` attribute can be applied only to variables.
- Only one variable can be allocated in a particular common block. Therefore, the name of the common block cannot be used as the name of another common block or program section.
- If an VSI Pascal program shares a record variable with a FORTRAN program, the fields must be laid out identically in both common blocks.
- Variables declared with the `COMMON` attribute are longword aligned by default for compatibility with other VSI languages.

For More Information:

- On default allocation for variables declared in the outermost block of a program or in nested blocks (Section 10.2.5)
- On default allocation for variables declared in the outermost block of a module (Section 10.2.36)
- On environment-specific information on common blocks (Appendix A)

10.2.13. ENUMERATION_SIZE

The `ENUMERATION_SIZE` attribute controls the allocation size of unpacked enumerated types and Booleans, which are considered enumerated types containing two elements. The `ENUMERATION_SIZE` attribute can be used on compilation units, `TYPE` sections, and `VAR` sections. When used before a `TYPE` or `VAR` section, the allocation size for enumerated types is modified *only* for the duration of the `TYPE` or `VAR` section. Note that specifying the `ENUMERATION_SIZE` attribute overrides any value that you previously specified with the `/ENUMERATION_SIZE` qualifier.

The `ENUMERATION_SIZE` attribute has the following format:

```
[ENUMERATION_SIZE (keyword)]
```

For example:

```
[ENUMERATION_SIZE (Byte)]
TYPE
    enum = (red, blue, green)
    enum2 = (circle, square, triangle);
```

Table 10.3 lists the keywords for the `ENUMERATION_SIZE` attributes.

Table 10.3. ENUMERATION_SIZE Attribute Keywords

Keyword	Description	Default on
BYTE	Allocates unpacked enumerated types with fewer than 255 elements and Booleans in a 8-bit byte. Otherwise, the enumerated types are allocated in a 16-bit word.	OpenVMS VAX systems
LONG	Allocates all unpacked enumerated types and Booleans in a 32-bit longword.	VSI OpenVMS I64 and VSI OpenVMS Alpha systems

10.2.14. ENVIRONMENT

You can apply the `ENVIRONMENT` attribute to compilation units, which causes the unit's program or module-level declarations and definitions to be saved.

```
ENVIRONMENT [[ ( name-string )]]
```

If the name string is omitted, the name of the source file is used as the environment file name.

The declarations and definitions made at the outermost level of the compilation unit (provided they do not have the `AUTOMATIC` or `HIDDEN` attribute) are saved in a newly created environment file. If the name string is specified, you must include a legal file specification.

Usage and Default Information:

- There is a default file type of .PEN for environment files if a file name is specified.
- If you do not specify a file name with the [ENVIRONMENT] attribute, then the file name of the source file is used with a .PEN extension for the name of the environment file. For example:

```

{
  Module share_data.pas
}
[ENVIRONMENT]
Module Share_Data;
  CONST
    Rate_For_Q1  = 0.1211;
    Rate_For_Q2  = 0.1156;
END.
```

The above module, when compiled, would result in the creation of an environment file named “share_data.pen.”

- The ENVIRONMENT attribute can not be specified on a program that declares nonstatic types or variables of nonstatic types at the outermost level.
- The ENVIRONMENT attribute can be specified on a module that declares nonstatic types or variables of nonstatic types at the outermost level.
- Programs and modules can access definitions and declarations in a created environment file by using the INHERIT attribute.

For More Information:

- On name-string syntax (Section 10.1)
- On static and nonstatic types (Section 2.9)
- On programs and modules (Section 7.4)
- On examples of separate compilation (*VSI Pascal for OpenVMS User Manual*)

10.2.15. EXTERNAL

The EXTERNAL attribute indicates a variable or routine that is assumed to be global in another independently compiled unit.

```

      {identifier      }
[ EXTERNAL [[ ( {'string-literal' } ) ]] ]
      {                }
```

identifier

Identifier passed to the linker. It is passed in uppercase. If you omit the identifier, the name of the variable is used as the name of the common block.

string-literal

Passes the specified string-literal to the linker unmodified.

If you specify an identifier with `EXTERNAL`, VSI Pascal supplies that name, rather than the identifier being declared, to the linker.

Usage and Default Information:

- The names available to the linker for corresponding global and external variables and routines must be identical.
- Global and external variables are implicitly static. Thus, they conflict with the `AUTOMATIC` attribute.
- Compilation units cannot have the `EXTERNAL` or `WEAK_EXTERNAL` attribute.
- By default, global and external routines have the characteristics of unbound routines.
- External routines must be followed by the directive `EXTERN`, `EXTERNAL`, or `FORTTRAN` when they are declared.

Consider the following example:

```
PROGRAM Freshman_Class;

[GLOBAL( Sort_Students )]
PROCEDURE Class_List( VAR Register_List, Sorted_List : Student_Rec );
{Procedure body...}

{In another compilation unit:}
MODULE Senior_Class;

[EXTERNAL( Sort_Students )]
PROCEDURE Roll_Call( VAR Start_List, End_List : Senior_Rec ); EXTERNAL;
```

This example shows the global declaration of a procedure with the name `Sort_Students` and an external reference to the same procedure in a different compilation unit.

For More Information:

- On default visibility attribute information (Section 10.2.25)
- On the `GLOBAL` attribute (Section 10.2.17)
- On the `AUTOMATIC` attribute (Section 10.2.5)
- On the `UNBOUND` attribute (Section 10.2.39)
- On compiling and linking (*VSI Pascal for OpenVMS User Manual*)

10.2.16. FLOAT

The `FLOAT` attribute selects the default format for `REAL` and `DOUBLE` data types. The `FLOAT` attribute has the following format:

```
[FLOAT (keyword) ]
```

You can specify the following keywords for this attribute:

- `D_FLOAT` yields `REAL=F_FLOATING`, `DOUBLE=D_FLOATING`

- G_FLOAT yields REAL=F_FLOATING, DOUBLE=G_FLOATING
- IEEE_FLOAT yields REAL=S_FLOATING, DOUBLE=T_FLOATING

For More Information:

- On floating-point numbers (Section 2.2)

10.2.17. GLOBAL

The GLOBAL attribute provides a strong definition of a variable or routine so that other independently compiled units can refer to it.

```
[ GLOBAL [[ ( { 'string-literal' } ) ]] ]
      {
      }
```

identifier

Identifier passed to the linker. It is passed in uppercase. If you omit the identifier, the name of the variable is used as the name of the common block.

string-literal

Literal passed, unmodified, to the linker.

Usage and Default Information:

- You can apply the GLOBAL attribute to variables, routines, and compilation units. When used on a MODULE, the GLOBAL attribute changes the name of the compiler-generated TO BEGIN DO section if present.
- Global and external variables are implicitly static. Thus, they conflict with the AUTOMATIC attribute.
- By default, global and external routines have the characteristics of unbound routines.
- You cannot apply the GLOBAL attribute to variables of nonstatic types.

For More Information:

- On default visibility attribute information (Section 10.2.25)
- On an example of GLOBAL and on the EXTERNAL attribute (Section 10.2.15)
- On compiling and linking (*VSI Pascal for OpenVMS User Manual*)

10.2.18. HIDDEN

The HIDDEN attribute prevents information concerning a constant definition or a type, variable, procedure, or function declaration from being included in a generated environment file. You can only use the HIDDEN attribute on objects at the outermost level of the compilation unit.

It is possible to prevent all declarations within a declaration section from being included in the environment file by preceding the reserved word CONST, TYPE, or VAR with the HIDDEN attribute.

For More Information:

- On environment files (Section 10.2.14)

10.2.19. IDENT

You can use the IDENT attribute to qualify the name of a compilation unit. In the absence of an IDENT attribute, the string '01' is supplied to the linker.

```
IDENT( name-string )
```

The name-string can contain additional information whose use is implementation specific. The VSI Pascal compiler uses this string to supply identification information to the linker.

Consider the following example:

```
[IDENT( '100.5' ), ENVIRONMENT( 'sample.pen' )] MODULE SAMPLE;
```

In this example, the IDENT string '100.5' is supplied to the linker.

For More Information:

- On name-string syntax (Section 10.1)
- On compiling and linking (*VSI Pascal for OpenVMS User Manual*)

10.2.20. IMMEDIATE

The IMMEDIATE attribute causes a formal parameter value in a routine declaration to be passed by immediate value. This attribute can be used on scalar and floating-point parameters that are passed by immediate value. On VSI OpenVMS I64 and VSI OpenVMS Alpha systems, the parameter must be 64 bits or smaller. On OpenVMS VAX systems, the parameter must be 32 bits or smaller.

Note

The IMMEDIATE attribute is not allowed on formal parameters of schema types.

For More Information:

- On default parameter passing (Section 6.3)
- On an example of IMMEDIATE and on the REFERENCE attribute (Section 10.2.35)

10.2.21. INHERIT

The INHERIT attribute indicates the environment file or files to be inherited by a compilation unit. The environment files specified by the INHERIT attribute must already have been created in compilation units (by either the ENVIRONMENT attribute or a compilation switch).

The compilation unit inherits one or more environment files named by the file specifications in the name strings.

```
INHERIT( {name-string}, ... )
```

Usage and Default Information:

There is a default file type of .PEN for inherited environment files.

For example:

```
{
  Program inherit_example.pas
}
[INHERIT ('share_data')]
Program inherit_example(output);
  CONST
    My_Rate    = Rate_For_Q1*2.0;
BEGIN
  Writeln(My_Rate)
END.
```

When the preceding program is compiled, the compiler first attempts to open the file 'share_data' as an environment file. If 'share_data' is not found the compiler attempts to open 'share_data.pen' as an environment file. If 'share_data.pen' is not found an error message is issued and the compilation is stopped.

For More Information:

- On programs and modules (Section 7.4)
- On compilation switches and separate compilation (*VSI Pascal for OpenVMS User Manual*)

10.2.22. INITIALIZE

You can apply the INITIALIZE attribute to procedures to indicate that the procedure is to be called before the main program is entered. A compilation unit might include any number of INITIALIZE procedures, all of which are called in an unspecified order before the main program is entered.

Usage and Default Information:

- In the absence of the INITIALIZE attribute, the compiler assumes that a routine can be activated only by actual calls within the program.
- Within modules, you should use the TO BEGIN DO section instead of the INITIALIZE attribute. All TO BEGIN DO clauses are executed before INITIALIZE routines.
- By default, INITIALIZE procedures have the characteristics of unbound routines.
- An INITIALIZE procedure cannot have a formal parameter list.
- An INITIALIZE procedure cannot be external.

Consider the following example:

```
PROGRAM Routine_Activate;

[INITIALIZE] PROCEDURE Check_Open; {Procedure body...}

{In the executable section:}
BEGIN {VSI Pascal activates Check_Open}
```

```
{Body of program...}
```

In this example, the body of the INITIALIZE procedure Check_Open is executed before the main program is activated.

For More Information:

- On procedures (Section 6.1)
- On the UNBOUND attribute (Section 10.2.39)

10.2.23. KEY

You can apply the KEY attribute to record fields to indicate that the field is to be used as a key field when the record is part of an indexed file.

```
KEY [[ ( {n} [, {options}, ... ] ) ] ]
```

n

The parameter *n* represents the key number. A key number of 0 indicates that the field is the primary key of the record. All other key numbers indicate alternate keys. The key number must be a constant expression that denotes an integer value in the range from 0 through 254.

options

The options parameter lets you specify certain characteristics of the record key by listing the desired options on the KEY attribute.

Table 10.4 lists the possible KEY attribute options.

Table 10.4. KEY Attribute Options

Option	Action	Negation
ASCENDING	Specifies an ascending collating sequence	DESCENDING
CHANGES	Specifies that changes can be performed on the key	NOCHANGES
DUPLICATES	Specifies that duplicates of the key are allowed	NODUPLICATES

Usage and Default Information:

- If you omit the key number, the default value is 0.
- By default, the primary key is ASCENDING, NOCHANGES, and NODUPLICATES. It is possible to override these defaults, with the exception of the NOCHANGES option. It is illegal to specify CHANGES on the primary key.
- The default for an alternate key is ASCENDING, CHANGES, and DUPLICATES.
- When you create a new indexed file with more than one key field, you cannot omit any key numbers in the range from 0 through the highest key number specified.

- The **KEY** attribute is ignored except when the record is a component of a file.
- A key field can be of any ordinal type or of type **PACKED ARRAY OF CHAR**. If the key field is of type **PACKED ARRAY OF CHAR**, its length cannot exceed 255 characters.
- The **KEY** attribute does not affect type compatibility rules.
- A key field cannot be unaligned.
- A key field of an ordinal type must be allocated in exactly one byte, one word, one longword, or one quadword. (Key fields can be allocated in a quadword only on VSI OpenVMS I64 and Alpha systems.)
- An integer key field that is allocated one byte cannot have negative values.

Consider the following example:

```

TYPE
  Register = RECORD
    Student_No      : [KEY( 0, DESCENDING )] INTEGER;
    Student_Name    : RECORD
      Last_Name     : PACKED ARRAY[1..20] OF CHAR;
      First_Name    : PACKED ARRAY[1..15] OF CHAR;
      Initial       : CHAR;
    END;
    Course_Load     : INTEGER;
    Grade_Average   : REAL;
    Class           : [KEY( 1 )] PACKED ARRAY[1..9] OF CHAR;
  END;

```

This example defines the identifier **Register** to denote a record type. The first field, **Student_No** is the primary key of the record. It has been defined as a **DESCENDING**, **NOCHANGES**, and **NODUPLICATES** key. **Register** contains another field, **Class**, which is established as the alternate **ASCENDING**, **CHANGES**, and **DUPLICATES** key.

For More Information:

- On indexed files (Section 9.1.3)
- On the **UNALIGNED** attribute (Section 10.2.38)

10.2.24. LIST

You can apply the **LIST** attribute to a formal parameter of a routine and indicates that the routine can be called with multiple actual parameters that correspond to the last formal parameter named in the routine heading.

You can also use the **ARGUMENT** and **ARGUMENT_LIST_LENGTH** predeclared routines when writing procedures and functions that use the **LIST** attribute.

Usage and Default Information:

- In the absence of a **LIST** attribute, an error results if the number of actual parameters exceeds the number of formal parameters.
- You can apply the **LIST** attribute only to the last formal parameter in a parameter list.

- You can supply zero, one, or more than one actual parameter to correspond to a LIST formal parameter, but you must use positional syntax when supplying them. The number of actual parameters you can supply is limited to 255.
- You can use the LIST attribute on the parameter list of a routine parameter, but you must use positional syntax when specifying them. Using the LIST attribute on routine parameters is allowed only on external routines.
- You can use the LIST attribute on conformant parameters to indicate that an external routine can take an arbitrary number of arrays or VARYING OF CHAR parameters, respectively. Using the LIST attribute on conformant parameters is allowed only on external routines.
- All actual parameters that correspond to a LIST formal parameter must be compatible or congruent with the type of the formal parameter.
- For formal and actual parameter lists of routine parameters to be congruent, the actual routine parameter and the corresponding formal routine parameter must either both have the LIST attribute or both lack the LIST attribute. Consider the following example:

```
PROCEDURE Foo( PROCEDURE q( x : [LIST] CHAR ) );
```

This defines the routine Foo with the formal routine parameter q that defines the formal list parameter x. Consider the following example:

```
PROCEDURE Bar( x : [LIST] CHAR );
```

This defines Bar to have a formal list parameter x. Consider this call to Foo:

```
Foo( Bar );
```

This calls Foo passing the actual routine parameter Bar. The formal parameters of q and Bar contain the LIST attribute, so this is a legal call.

For example, the function Average demonstrates the use of the LIST attribute, which allows any number of like expressions to be passed to a function:

```
PROGRAM Use_List (OUTPUT);  
  FUNCTION Average ( P: [list] INTEGER): REAL;  
    VAR  
      SUM: REAL VALUE 0.0;  
      I: INTEGER;  
    BEGIN  
      FOR I:= 1 TO ARGUMENT_LIST_LENGTH(P) DO  
        SUM:= SUM + ARGUMENT (P,I);  
      AVERAGE:= SUM/ARGUMENT_LIST_LENGTH(P);  
    END;  
BEGIN  
WRITELN (AVERAGE (3, 6, 9) , AVERAGE (10, 3, 4, 17) );  
END.
```

For More Information:

- On the ARGUMENT function (Section 8.7)
- On the ARGUMENT_LIST_LENGTH function (Section 8.8)
- On type compatibility (Section 2.10)

10.2.25. LOCAL

The LOCAL attribute indicates that an object is unavailable to other independently compiled units.

Usage and Default Information:

- By default, all variables and routines are local.
- Variables with any visibility attribute other than LOCAL are implicitly static.
- Routines with any visibility attribute other than LOCAL cannot refer to automatic variables declared in enclosing blocks and can call only those routines that are local, predeclared, or unbound. (By default, routines declared at program or module level have the characteristics of unbound routines.)

For More Information:

- On the AUTOMATIC attribute (Section 10.2.5)
- On static and nonstatic types (Section 10.2.36)
- On the UNBOUND attribute (Section 10.2.39)

10.2.26. LONG

The LONG attribute specifies the amount of storage in longwords to be received by the object.

```
LONG [[ ( n ) ]]
```

The optional constant *n* indicates the number of longword storage units.

Consider the following example:

```
PROGRAM Size;
TYPE
    Status = [LONG] BOOLEAN;
VAR
    Return_Status : Status;

FUNCTION Example( Param1, Param2 : INTEGER ) : Status; EXTERNAL;
    {Function body...}
```

The program `Size` defines a `BOOLEAN` type `Status` and declares a variable `Return_Status` of this type. So, the result type of the function is declared to have a size of one longword. The machine code that references the result type can not copy the entire longword, however, if the default size for a Boolean is less than a longword.

For More Information:

- On allocation sizes of objects (Section A.2.4)
- On size allocation restriction (Section 10.2.6)
- `ACCURATE` (Default)
- `FAST`

10.2.27. NOOPTIMIZE

The `NOOPTIMIZE` attribute prohibits the compiler from optimizing code for the compilation unit or routine. The `NOOPTIMIZE` attribute can only be applied to routines on OpenVMS VAX systems.

On OpenVMS VAX systems, the `NOOPTIMIZE` attribute guarantees left-to-right evaluation order with full evaluation of both operands of the `AND` and `OR` Boolean operators to aid in diagnosing all potential programming errors. On VSI OpenVMS I64 and VSI OpenVMS Alpha systems, `NOOPTIMIZE` only guarantees full evaluation.

If you wish to have short circuit evaluation even with the `NOOPTIMIZE` attribute, then use the `AND_THEN` and `OR_ELSE` Boolean operators.

For More Information:

- On the `OPTIMIZE` attribute (Section 10.2.29)
- On the `AND_THEN` and `OR_ELSE` logical operators (Section 4.2.3)

10.2.28. OCTA

The `OCTA` attribute specifies the amount of storage in octawords to be received by the object.

```
OCTA [[ ( n ) ]]
```

The optional constant *n* indicates the number of octaword storage units.

For More Information:

- On allocation sizes of objects (Section A.2.4)

- On size allocation restriction (Section 10.2.6)

10.2.29. OPTIMIZE

The `OPTIMIZE` attribute specifies optimization options that are to be enabled during compilation of a compilation unit or routine.

```
OPTIMIZE [[ ( {identifier}, ... ) ]]
```

The options listed with the `OPTIMIZE` attribute are enabled. The negation of an option disables that optimization. The valid options are `ALL`, `NONE`, `INLINE`, `NOINLINE`. Table 10.5 lists the options.

Table 10.5. OPTIMIZE Attribute Options

Option	Action
[OPTIMIZE], [OPTIMIZE(ALL)]	Enables all optimization components. Inline expansion of user-defined routines is enabled in automatic selection mode.
[OPTIMIZE(NOINLINE)]	Disables inline expansion for user-defined routines. All other optimization components are enabled or disabled according to the command line or the setting of the <code>OPTIMIZE</code> attribute on an enclosing scope routine.
[OPTIMIZE(INLINE)]	Enables preferential inline expansion of user-defined routines. All other optimization components are enabled/disabled according to the command line on an enclosing scope routine.
[OPTIMIZE(ALL,NOINLINE)]	Enables all optimization components, disables inline expansion for user-defined routines.
[OPTIMIZE(NONE,INLINE)]	Disables all optimization components, enables inline expansion of user-defined routines.
[NOOPTIMIZE], [OPTIMIZE(NONE)]	Disables all optimization components, disables inline expansion of user-defined routines.

Usage and Default Information:

- This attribute can be applied to routines and compilation units.
- Optimization features specified with the `OPTIMIZE` attribute override command-line settings and settings inherited from outer scopes.
- The `INLINE` option specifies that a routine should be inlined preferentially, regardless of the results of heuristics that are normally used to automatically determine if a routine is to be inlined. There are cases where a routine that is marked as `INLINE` preferred will not be inline expanded, such as routines that have formal parameters of nonstatic types, or that declare or access nonstatic types.
- If no `OPTIMIZE` attribute is specified for a routine in a nested scope, the `OPTIMIZE` attribute settings from the enclosing routine are used.

Usage and Default Information on VSI OpenVMS I64 and VSI OpenVMS Alpha systems only:

- If the `OPTIMIZE` attribute is used on a routine on VSI OpenVMS I64 or VSI OpenVMS Alpha systems, only the `INLINE` and `NOINLINE` keywords are processed. The other forms of the

OPTIMIZE attribute are parsed, but perform no function. You cannot modify the optimization settings of individual routines on these systems.

Usage and Default Information on OpenVMS VAX systems only:

- On OpenVMS VAX systems, if an explicit OPTIMIZE(INLINE) attribute exists on a routine declaration, the compiler checks for anything that prohibits inline expansion of the routine, such as it being an external routine. However, the compiler does not check the call environment, such as the size of the calling and called routine. Instead, if it is legal to expand the routine, it always expands the code regardless of the call environment. This gives you more control over the decision to inline a routine.
- On OpenVMS VAX systems, VSI Pascal does not inline routines that have formal parameters of nonstatic types, or that declare or access objects of nonstatic types.

For More Information:

- On the NOOPTIMIZE attribute (Section 10.2.27)
- On the rules for routine inlining (*VSI Pascal for OpenVMS User Manual*)

10.2.30. PEN_CHECKING_STYLE

VSI Pascal in cooperation with the VSI OpenVMS Linker performs compile-time and link-time checks to ensure that all compilations that inherit environment files actually used the same environment file definition. Information is placed in the object file such that the VSI OpenVMS Linker will perform the same check between each object file that inherited environment files.

By default, compilation units that inherit an environment file compare the embedded compilation time inside the environment file against uses found in any other environment files that are also inherited. If the times are different, a compile-time message is displayed. This happens on all systems.

This checking can be disabled or modified by using the PEN_CHECKING_STYLE attribute in the Pascal source file that created the environment file. Once the environment file exists, its selected checking style will be performed at each use.

The PEN_CHECKING_STYLE attribute is valid at the beginning of a MODULE that creates an environment. The syntax is:

```
PEN_CHECKING_STYLE (keyword)
```

In this syntax, *keyword* is:

- **COMPILATION_TIME**
Uses the compilation time of the environment file in all subsequent compile-time checking for users of this environment file. This is the default.
- **IDENT_STRING**
Uses the [IDENT()] string of the environment file in all subsequent compile-time checking for users of this environment file.
- **NONE**
Disables all compile-time checking for users of this environment file.

10.2.31. POS

The POS attribute forces the field to a specific bit position within the record.

```
POS ( n )
```

n

The constant expression n specifies the bit location, relative to the beginning of the record, at which the field begins.

Usage and Default Information:

- You can apply the POS attribute to a field of a packed or an unpacked record.
- The constant expression n cannot denote a negative integer.
- The beginning position of a field must be greater than the ending position of the field preceding it.
- The POS attribute cannot be used on a field that follows (not necessarily immediately) a field whose type has run-time size and is nonstatic.
- Inside a record variant, the beginning position of a field must be greater than the ending position of the preceding field within the same variant. The variants themselves can overlap.
- A field whose allocation size is greater than 32 bits must be positioned according to the allocation size rules for the platform.
- A record variable containing a field of a file type cannot include a POS attribute for any field.
- The specified bit position must not conflict with the alignment explicitly required by an alignment attribute.
- Two record types in which corresponding fields are not identically positioned are neither assignment compatible nor structurally compatible.

Consider the following example:

```
TYPE
  Control = RECORD
    Flag_1 : [ BIT, POS( 0 ) ] BOOLEAN;
    Flag_2 : [ BIT, POS( 1 ) ] BOOLEAN;
    Count  : [ BYTE, ALIGNED ] 0..100;
    Error  : [ BIT, POS( 31 ) ] BOOLEAN;
  END;
```

This example uses the POS attribute to position the fields of an unpacked record such that Flag_1 occupies bit 0, Flag_2 occupies bit 1, and Error occupies bit 31. Because the Count field has size and alignment attributes, it is allocated one byte of storage and is aligned on the byte boundary following Flag_2; that is, storage for Count occupies bits 8 through 15. Bits 2 through 7 and 16 through 30 are left empty; you cannot refer to them.

For More Information:

- On allocation sizes of objects (Section A.2.4)

- On alignment boundaries in packed and unpacked records (Section A.2.7)
- On static and nonstatic types (Section 2.9)
- On type compatibility (Section 2.10)

10.2.32. PSECT

The PSECT attribute is useful for placing static variables and executable blocks in program sections that are shared among executable images.

```
[ PSECT [[ ( { identifier } ) ]] ]
```

identifier

Identifier passed designating the program section in which storage for a variable, routine, or compilation is to be allocated. If you omit the identifier, the name of the variable is used as the name of the program section.

Usage and Default Information:

- A variable having the AT, COMMON, or PSECT attribute is implicitly static.
- PSECT is the only allocation attribute that can be applied to routines and compilation units.

For More Information:

- On default allocation for variables declared in the outermost block of a program or in nested blocks (Section 10.2.5)
- On default allocation for variables declared in the outermost block of a module (Section 10.2.36)
- On program sections (Appendix A)

10.2.33. QUAD

The QUAD attribute specifies the amount of storage in quadwords to be received by the object.

```
QUAD [[ ( n )]]
```

The optional constant n indicates the number of quadword storage units.

For More Information:

- On storage allocation for objects (Section A.2.5)
- On default sizes of objects (Section A.2.4)
- On size allocation restriction (Section 10.2.6)

10.2.34. READONLY

The READONLY attribute specifies that an object can be read by a program but it cannot have values assigned to it.

Usage and Default Information:

- You can apply this attribute to variables, formal parameters, the base types of pointer variables, and components of structured variables.
- By default, an object can be both read and written.
- No value of any type is assignment compatible with a read-only object.
- The presence of a read-only component in an object of a structured type prohibits the object from having values assigned to it.
- You can only pass a read-only actual VAR parameter to a read-only formal VAR parameter.
- A pointer expression whose base type is read-only is assignment compatible only with a pointer variable whose base type is also read-only.

Consider the following example:

```

TYPE
  t = RECORD
    i : INTEGER;
  END;
  P_Read_Only = ^ [READONLY] t;
VAR
  Pro : P_Read_Only;
  Prw : ^ T;

PROCEDURE q( p : P_Read_Only);
  VAR
    x : INTEGER;
  BEGIN
    x := p^.i;
    {More statements...}
  END;
{In the executable section:}
NEW( Pro );
NEW( Prw );
Q( Pro );
Q( Prw );
Prw^.I := 0;

```

This example shows the declaration of two pointer variables, `Pro` and `Prw`, and the calls to `NEW` that create the dynamic variables `Pro^` and `Prw^`. The type of the formal parameter `p` requires that a corresponding actual parameter have read access; therefore, both `Pro` and `Prw` can legally be passed to `Q` as actual parameters. Because `P` is a `READONLY` parameter, the value of the dynamic variable `P^` (which corresponds to either `Pro^` or `Prw^`) can be assigned to a variable, as shown in the assignment statement in the body of `Q`. However, only `Prw^` can have values assigned to it, as shown in the last statement.

For More Information:

- On the `NEW` procedure (Section 8.58)
- On parameters (Section 6.3)
- On type compatibility (Section 2.10)

10.2.35. REFERENCE

The REFERENCE attribute causes the formal parameter value in a routine to be passed by reference using foreign semantics.

Usage and Default Information:

- The REFERENCE attribute is not allowed on formal parameters of schema types.

Consider the following example:

```
PROCEDURE Test1( P1 : [REFERENCE] INTEGER;  
                P2 : [IMMEDIATE] INTEGER ); EXTERNAL;
```

This example defines a procedure, Test1, which has two parameters. The first parameter, P1, is passed by reference. The second parameter, P2, is passed by immediate value.

For More Information:

- On default parameter passing (Section 6.3)
- On the IMMEDIATE attribute (Section 10.2.20)

10.2.36. STATIC

The STATIC attribute causes VSI Pascal to create a static object, which is allocated only once and exists as long as the executable image in which it is allocated remains active.

Usage and Default Information:

- You can override the default (automatic) for variables declared in nested blocks or in the outermost level of compilation units by specifying the STATIC attribute on the variable.
- By default, variables declared at the outermost level of a module are static.
- Global and external variables are implicitly static so they conflict with the AUTOMATIC attribute.
- A variable having the AT, COMMON, or PSECT attribute is implicitly static.
- Allocation attributes can not be applied to nonstatic types.

Consider the following example:

```
PROGRAM Print_Random( OUTPUT );

VAR
    i : [AUTOMATIC] INTEGER;

FUNCTION Random : INTEGER;
    VAR
        x : [STATIC] INTEGER VALUE 15;
    BEGIN
        x := (( 9 * x ) + 7 ) MOD 11;
        Random := x;
    END;
{In the executable section:}
FOR i := 1 TO 20 DO
    WRITELN( Random );
END.
```

The program `Print_Random` includes a function that generates a random integer. Because the variable `x` is declared `STATIC`, its value is preserved from one activation of the function to the next. By default, the storage for `x` would have been deallocated when control returned to the main program. Because `x` is static, it retains the value it had when `Random` ended and assumes this value the next time `Random` is called. In the program `Print_Random`, the program-level variable `i` is declared `AUTOMATIC`.

For More Information:

- On the `AUTOMATIC` attribute (Section 10.2.5)
- On allocation attributes (Section 10.3)
- On default storage of objects (Section A.3)

10.2.37. TRUNCATE

The `TRUNCATE` attribute indicates that an actual parameter list for a routine can be truncated at the point that the attribute was specified. You can use `TRUNCATE` with the `PRESENT` function.

Usage and Default Information:

The examples in this list are based on this `PROCEDURE` declaration from Example 10.1, which shows the use of the `TRUNCATE` attribute with default values:

```
PROCEDURE p( a : [TRUNCATE] CHAR := 'a';
             b : CHAR := 'b';
             c : [TRUNCATE] CHAR := 'c';
             d : CHAR := 'd' );
```

- You can specify the `TRUNCATE` attribute on a formal parameter in a routine declaration.
- If a parameter with the `TRUNCATE` attribute is present in the actual parameter list (explicitly with a null actual parameter, or by being skipped over by a nonpositional actual parameter), then the list is not truncated at the `TRUNCATE` parameter. All parameters (including the current `TRUNCATE` parameter) up to the next parameter that specifies `TRUNCATE` must be present or have a default value. The first parameter is present in this call from Example 10.1 so the list is not truncated at the

first parameter. The second parameter has a default value so it is included in the result. The third parameter, however, is not present in the actual parameter list so the parameter list is truncated:

```
p ( );           { DEFAULT a AND b--TRUNCATE AT c "ab" }
```

- If a parameter with the TRUNCATE attribute is present by default, the list is not truncated at that point. In this line of code from Example 10.1, the first, second, and third parameters are present by default. Because the third parameter is present, the parameter list is not truncated and all four parameters are present in the result.

```
p ( , , );      { DEFAULT a, b, c AND d           "abcd" }
```

- You can specify actual parameters either positionally or nonpositionally; it is the order in the formal parameter list that is used to determine where the list has been truncated and which parameters are required. Because c, the third parameter, is present in the actual list, the parameter list is not truncated.

```
p ( c := y );   { DEFAULT a, b AND d           "abyd" }
```

- If a parameter is positioned after the TRUNCATE parameter in the formal parameter list and is present (explicitly with a null actual parameter or by being skipped over by a nonpositional actual parameter), then the list is not truncated at the TRUNCATE parameter. Any parameters after the TRUNCATE parameter must be present or have a default value.

In Example 10.1, each call to procedure p in the main body of the program has a comment that shows the expected parameter list behavior and the expected output. The parameter list is truncated at either parameter a or parameter c.

If parameters b and d did not have default values, the call p(w) or p(w, x, y) would be illegal because the list cannot be truncated at the second or fourth positions.

Example 10.1. Using the TRUNCATE Attribute

```
PROGRAM Trunc( OUTPUT );
VAR
  w   : CHAR VALUE 'w';
  x   : CHAR VALUE 'x';
  y   : CHAR VALUE 'y';
  z   : CHAR VALUE 'z';
PROCEDURE p( a : [TRUNCATE] CHAR := 'a';
             b :           CHAR := 'b';
             c : [TRUNCATE] CHAR := 'c';
             d :           CHAR := 'd' );
BEGIN
  IF PRESENT( a ) THEN WRITE( a );
  IF PRESENT( b ) THEN WRITE( b );
  IF PRESENT( c ) THEN WRITE( c );
  IF PRESENT( d ) THEN WRITE( d );
  WRITELN;
END;
{In the executable section:}
{ CALL          LIST                                RESULT }
p;              { NO PARAMETERS--TRUNCATE AT a     ""      }
p();            { DEFAULT a AND b--TRUNCATE AT c   "ab"   }
p( , );        { DEFAULT a AND b--TRUNCATE AT c   "ab"   }
p( , , );      { DEFAULT a, b, c AND d                 "abcd" }
p( , , , );    { DEFAULT a, b, c AND d                 "abcd" }
```

```

p( w );           { DEFAULT b--TRUNCATE AT c      "wb"  }
p( w, x );        { TRUNCATE AT c                "wx"  }
p( w, x, y );     { DEFAULT d                    "xyd" }
p( w, x, y, z );  { NO DEFAULTS                 "xyz" }
p( a := w );      { DEFAULT b--TRUNCATE AT c      "wb"  }
p( b := x );      { DEFAULT a--TRUNCATE AT c      "ax"  }
p( c := y );      { DEFAULT a, b AND d           "abyd" }
p( d := z );      { DEFAULT a, b AND c           "abcz" }

```

For More Information:

- On the PRESENT function (Section 8.69)
- On parameters (Section 6.3)

10.2.38. UNALIGNED

The UNALIGNED attribute specifies that an object can be aligned on any bit boundary.

Usage and Default Information:

- Alignment attributes are illegal on nonstatic types, components of files, and on VARYING OF CHAR strings.
- An unaligned variable must have an allocation size that conforms to the rules for the platform.
- A formal parameter cannot be unaligned so an unaligned variable cannot be passed to a formal variable parameter.
- The base type of a pointer variable passed to the NEW procedure cannot have alignment greater than a quadword, nor can it be unaligned.

For More Information:

- On allocation size attributes (Section 10.3)
- On VSI Pascal alignment rules (Section A.2.7)
- On allocation sizes of objects (Section A.2.4)

10.2.39. UNBOUND

The UNBOUND attribute specifies that a routine does not access automatic variables outside the scope in which it is declared. That is, the bound procedure value of an unbound routine does not include the static scope pointer.

Usage and Default Information:

- You can apply this attribute to routines and formal routine parameters.
- In the absence of an UNBOUND attribute, the compiler assumes that the bound procedure value of a routine includes the static scope pointer.
- By default, all predeclared routines and all routines declared at program or module level have the characteristics of unbound routines. All routines declared in nested blocks are considered bound unless they have an UNBOUND, GLOBAL, WEAK_GLOBAL, or INITIALIZE attribute.

- All routines called from within the block of an unbound routine must be local to the unbound routine, or be unbound, whether by default or by an explicit attribute.
- Nonlocal variables accessed from within the block of an unbound routine cannot have automatic allocation.
- If a formal routine parameter is unbound, all actual routine parameters passed to it must also be unbound.
- You can pass an unbound routine as an actual parameter to a formal routine parameter that is not unbound.

Consider the following example:

```
[EXTERNAL] FUNCTION f( [IMMEDIATE, UNBOUND] PROCEDURE Count )
    : BOOLEAN; EXTERNAL;

PROCEDURE a;
    VAR
        i : [STATIC] INTEGER;
        b : BOOLEAN;

    [UNBOUND] PROCEDURE p;
        BEGIN
            i := i + 1;
            {Additional statements...}
        END;
    b := f( p );
END;
```

This example shows the declaration of the unbound procedure `p` and the unbound formal procedure parameter `Count`. The executable section of `p` cannot access variables declared in the enclosing block of procedure `a` unless those variables are statically allocated. Procedure `p` can access the variable `i`, which is declared with the `STATIC` attribute, but it cannot access the variable `b` that is automatically allocated. Because the formal parameter `Count` is unbound, only other unbound routines (such as `p`) can be passed to function `f` as actual parameters. `Count` must be declared `UNBOUND` because it is passed by immediate value.

For More Information:

- On the `AUTOMATIC` attribute (Section 10.2.5)
- On parameters (Section 6.3)

10.2.40. UNSAFE

The `UNSAFE` attribute indicates that an object can accept values of any type without type checking. The exact properties of an unsafe object depend on the object's machine representation.

Usage and Default Information:

- You can apply this attribute to variables, formal parameters, formal discriminants, the base types of pointer variables, components of structured variables, function results, and the types of other data items listed in Table 10.9.
- A conformant `VARYING` parameter or a formal schema parameter cannot be declared `UNSAFE`.

- UNSAFE is the only attribute allowed on schema formal discriminants.
- An expression of any type is assignment compatible with an unsafe object. However, neither the expression nor the object can contain a file component. If the machine representations of the expression and the unsafe object differ, the compiler forces them to have the same number of bits by modifying the value of the expression as follows:
 - Assignment to a variable with the UNSAFE attribute causes the value of the right-hand side to be truncated or zero-extended to the bit size of the left-hand variable. Note this can not always be its natural bit size; for example, if the variable you are assigning a value to was declared with an explicit size attribute. If that value is the legal value of the left-hand type, then the assignment occurs; otherwise, the variable is undefined.
 - The UNSAFE attribute has no effect on variable fetches.

Consider the following example:

```
v : [LONG, UNSAFE] ( aa, bb, cc );
```

As an enumeration of less than 256 elements, its natural size can be less than a longword. Because of the LONG attribute, it is allocated a longword in memory. However, fetches from the variable might be smaller because the explicit size attribute has no effect on any fetches. Assignments correctly assign the natural size portion of V, but the contents of the extra bits are zero-extended at the assignment.

- A pointer expression is assignment compatible with a pointer variable whose base type is unsafe only if the base types have the same allocation size and if they have compatible alignment, READONLY, VOLATILE, and WRITEONLY attributes.
- You can pass an actual parameter variable to an unsafe formal VAR parameter if the types have the same allocation size and if they have compatible alignment, READONLY, VOLATILE, and WRITEONLY attributes.
- When a formal parameter is an unsafe conformant array, the VSI Pascal compiler must be able to establish bounds for the corresponding actual parameter that exactly describe the amount of storage the parameter occupies. If the conformant array is one-dimensional, the actual parameter need not be an array. The compiler constructs the bounds of the formal array so that the actual parameter and the formal array have the same size.

For this construction to be possible, the size of the actual parameter must be an exact multiple of the size of the formal array component. The compiler chooses the low bound of the formal parameter's index to be the smallest possible value of the index type. If the formal conformant parameter is a multidimensional array with n dimensions, the actual parameter must be an array having no fewer than $n - 1$ dimensions. The first $n - 1$ dimensions of the two arrays will have identical array bounds. The compiler chooses bounds for the last dimension of the conformant array so that the conformant as a whole describes the exact size of the actual parameter.

VSI Pascal allows you to pass an actual parameter of a schema type to the an unsafe conformant array; however, because VSI Pascal cannot determine the size of the actual parameter until run time, you must be sure that the actual parameter is an exact multiple of the size of the formal array component.

Consider the following example:

```
PROGRAM Output_Buffer( Data_File );  
TYPE
```

```
Natural = 0..MAXINT;
VAR
  Data_File : FILE OF ARRAY[0..511] OF CHAR;
  Int_Array : ARRAY[0..1023] OF INTEGER;
  A_String  : VARYING[2048] OF CHAR;
  Chr_Array : ARRAY[0..4095] OF CHAR;
  Status    : BOOLEAN;

FUNCTION Put_Buf( VAR Buffer :
                 [UNSAFE] ARRAY[ a..b : Natural ] OF CHAR )
                 : BOOLEAN;
VAR
  Cur : [STATIC] INTEGER VALUE 0;
  i   : INTEGER;
BEGIN
  FOR i := a TO b DO
    BEGIN
      Data_File^[Cur] := Buffer[i];
      Cur := Cur + 1;
      IF Cur > 511 THEN
        BEGIN
          PUT( Data_File);
          Cur := 0;
        END;
      END;
    Put_Buf := (Cur = 0);
  END;
{In the executable section:}
Status := Put_Buf( Int_Array );
Status := Put_Buf( A_String );
Status := Put_Buf( Chr_Array );
```

The function `Put_Buf` assigns successive components of the conformant array parameter to the file buffer variable of `Data_File`. If `Data_File^` is filled, the function returns `TRUE`; otherwise, it returns `FALSE`.

The program issues three calls to `Put_Buf`. In the first and second calls, the actual parameters are not of the same type as the formal parameter `Buffer`. However, because `Buffer` has the `UNSAFE` attribute, it accepts an actual parameter of any type and treats it as though it were an array of characters. The third call to `Put_Buf` passes an actual parameter of the same type as the formal parameter.

For More Information:

- On type compatibility (Section 2.10)
- On machine representation of data (Section A.3)

10.2.41. VALUE

The `VALUE` attribute causes the variable to be a reference to an external constant or to be the defining point of a global constant.

Usage and Default Information:

- You can only use the `VALUE` attribute on a variable that has the `EXTERNAL` or `GLOBAL` attribute.

- A value variable with global visibility must be initialized in the VAR, TYPE, or VALUE declaration sections.
- You cannot apply the VALUE attribute to variables larger than 64 bits on VSI OpenVMS I64 and VSI OpenVMS Alpha systems or 32 bits on OpenVMS VAX systems.
- The VALUE attribute is legal only on ordinal or real types.
- The VALUE attribute causes the READONLY attribute to be placed on the variable.

In this example, the linker resolves the reference to CLI\$_PRESENT; the example writes the decimal value to OUTPUT. The example also defines a global symbol with the name My_Global and with a value of 1985.

```
PROGRAM Value_Test( OUTPUT );
VAR
  CLI$_PRESENT : [VALUE, EXTERNAL] INTEGER;
  My_Global : [VALUE, GLOBAL] INTEGER VALUE 1985;
{In the executable section:}
WRITELN( 'The value is', CLI$_PRESENT );
```

For More Information:

- On the EXTERNAL attribute (Section 10.2.15)
- On the GLOBAL attribute (Section 10.2.17)
- On the READONLY attribute (Section 10.2.34)

10.2.42. VOLATILE

The VOLATILE attribute indicates to the compiler that the value of an object is subject to change at unusual points in program execution. Normally, during execution, an object's value changes only under the following circumstances:

- When another value is assigned to it
- When it is passed as a writable VAR parameter
- When it is read into by a READ, READLN, or READV procedure
- When it is used as the control variable of a FOR loop

In addition, the compiler expects to evaluate the object only when it appears in an expression.

The value of a volatile object can change as the result of an action not directly specified in the program. Thus, the compiler assumes that the value of a volatile object can be changed or evaluated at any time during program execution. Consequently, a volatile object does not participate in any optimization based on assumptions about its value.

The behavior of many device registers, and modifications by asynchronous processes and exception handlers, are two examples that demonstrate volatile behavior.

Usage and Default Information:

See Table 10.6, which also summarizes combinations of volatile and nonvolatile parameters and variables accepted by the compiler.

- You can apply this attribute to variables, formal parameters, the base types of pointer variables, components of structured variables, and function results.
- By default, objects are not volatile.
- An object of a structured type that has a volatile component is volatile as a whole. However, the presence of a volatile component does not make other components of the same variable volatile.
- The presence of the VOLATILE attribute guarantees that operations are performed on scalar objects in an atomic fashion. Because operations on structured objects can require many more instructions, the use of the VOLATILE attribute on an object of a structured type can not produce the expected results, if the data is accessed asynchronously.
- A volatile variable is structurally compatible only with a formal variable parameter that is volatile. The compiler does not allow a volatile variable to be passed to a nonvolatile formal VAR parameter because the called routine did not guarantee that it could handle volatile parameters.
- Formal VAR parameters with the VOLATILE attribute can accept both volatile and nonvolatile actual parameters; treating a nonvolatile variable as volatile never produces the wrong answer.
- A pointer expression whose base type is volatile is assignment compatible only with a pointer variable whose base type is volatile.
- Two pointer types are structurally compatible only if their base types have identical volatility.
- On VSI OpenVMS I64 and VSI OpenVMS Alpha systems, the VOLATILE attribute ensures true atomic accesses for bytes, aligned words, aligned longwords, and aligned quadwords. For unaligned words, unaligned longwords, or unaligned quadwords that are marked VOLATILE, the compiler will issue a warning message indicating that the resulting code sequence is not an atomic sequence and contains a timing window where incorrect results can occur if an asynchronous thread writes to the unaligned volatile storage.

See the *VSI Pascal for OpenVMS User Manual* for information on how to enable/disable the message.

VOLATILE accesses of items larger than 64 bits (strings, entire records, entire arrays, and other such items) have never been atomic in nature and are not flagged by the compiler. The VOLATILE attribute ensures atomic access for all objects 32 bits or less.

Table 10.6. Allowed Combinations of Volatile and Nonvolatile Parameters

Actual Parameter	Formal Parameter		
	VAR	VAR [VOLATILE]	[VOLATILE]
Volatile	No	Yes	Yes
Nonvolatile	Yes	Yes	Yes

Consider the following example:

```

VAR
  x : CHAR;
  a : [VOLATILE] RECORD
    CASE BOOLEAN OF
      FALSE : ( i : INTEGER );
      TRUE  : ( c : CHAR );
    END;
{In the executable section:}
a.c := 'A';      {TRUE becomes the current variant}

```

```

a.i := 66;           {Assignment makes FALSE the current variant}
x  := a.c;         {TRUE is again the current variant;
                   X is assigned the value 'B', which
                   has an ordinal value of 66}

```

As the comments in this example show, a reference to one field identifier causes the corresponding variant to become the current variant. In addition, each reference immediately causes the other variant to become undefined. So, when the assignment `a.i := 66` is made, the reference to `a.i` causes `FALSE` to become the current variant and `a.c` to become undefined. As a result of the statement `x := a.c`, the value last assigned to the variant is assigned to `x`. Ordinarily the compiler could assume that `a.c` had retained the value 'A', because no further assignments had been made directly to `a.c`. However, the value of `a.c` changed unexpectedly through the assignment to `a.i`. Therefore, unless the record `a` is declared `VOLATILE`, the result of the assignment `x := a.c` would be undefined because the compiler's legitimate assumptions had been incorrect.

Consider the following example:

```

PROGRAM Volatility( OUTPUT );
VAR
  Pint : ^[VOLATILE] INTEGER;
  i     : INTEGER;
  j     : [VOLATILE] INTEGER;
  a     : ARRAY[0..10] OF INTEGER;
{In the executable section:}
NEW( Pint );
i     := 0;
j     := 0;
Pint^ := 0;

{Compiler may assume i = 0, makes no assumptions about j}
WRITELN( i, j, Pint^, a[i] );   {Values are 0, 0, 0, a[0] }
Pint := ADDRESS( j );          {Pint^ now = j}
Pint^ := 1;                    {Therefore j now = 1}

{Compiler may assume i = 0, makes no assumptions about j}
WRITELN( i, j, Pint^, a[i] );   {Values are 0, 1, 1, a[0]}
Pint := ADDRESS( i );          {Causes a warning message
                               because i is not VOLATILE}
Pint^ := 2;

{Compiler may assume i = 0 and a[I] = a[0],
May make no assumptions about j}
WRITELN( i, j, Pint^, a[i] );   {Actual values are 2, 1, 2, a[2]}

```

This example assigns values to the variables `i` and `j` and to the newly created variable `Pint^`. The comments show the difference between the assumptions the compiler can legally make about the values of the variables and the values actually contained in the variables. The compiler's assumption about the value of `i` was incorrect because the value of `i` changed unexpectedly. The `ADDRESS(i)` call caused `Pint` to point to `i` (that is, `Pint^` and `i` became the same variable). When `Pint^` was assigned the value 2, the variable `i` also received the value 2. Since `i` had been initialized to 0 and was not directly referred to in the rest of the program, the compiler assumed that a reference to `i` at this point would be equivalent to a reference to 0. Likewise, the compiler also assumed that a reference to `a[i]` would be equivalent to a reference to `a[0]`. However, when execution ceases, the value of `i` is 2 and the value of `a[i]` is the value of `a[2]`.

Depending on the optimizations the compiler made based on the value of `i`, any operations performed after the unanticipated assignment to `i` could yield unexpected results. Because `j` was declared

VOLATILE, the compiler did not optimize code based on the value of *j*. Therefore, any reference to *j* yields the expected results.

The ADDRESS(*i*) call in this program causes a warning message. The VSI Pascal compiler assumes that pointer variables point only to variables in heap-allocated storage and not to statically allocated, nonvolatile variables such as *i*. So, ADDRESS(*i*) in this case differs from the expected usage.

For More Information:

- On use of VOLATILE with the ASYNCHRONOUS attribute (Section 10.2.3)
- On exception handlers (*VSI Pascal for OpenVMS User Manual*)
- On volatility (*VSI Pascal for OpenVMS User Manual*)

10.2.43. WEAK_EXTERNAL

The WEAK_EXTERNAL attribute specifies that a variable or routine is not critical to the linking operation. To resolve a weak reference, the linker searches only the named input modules. You can specify an identifier with this attribute to indicate the name by which the corresponding object is known to the linker.

```
[ WEAK_EXTERNAL [[ ( {identifier } ) ]] ]
                {
                }
```

identifier

Identifier passed to the linker. If you omit the identifier, the name of the variable is used as the name of the common block.

string-literal

Passes the specified string-literal to the linker unmodified.

Compilation units cannot have the EXTERNAL or WEAK_EXTERNAL attribute.

For More Information:

- On the EXTERNAL attribute (Section 10.2.15)
- On linking (*VSI Pascal for OpenVMS User Manual*)

10.2.44. WEAK_GLOBAL

The WEAK_GLOBAL attribute specifies that an object is linked only when it is specifically included in the linking operation. To resolve a weak reference, the linker searches only the named input modules. You can specify an identifier to indicate the name by which the corresponding object is known to the linker.

```
[ WEAK_GLOBAL [[ ( {identifier } ) ]] ]
                {
                }
```

identifier

Identifier passed to the linker. If you omit the identifier, the name of the variable is used as the name of the common block.

```
string-literal
```

Passes the specified string-literal to the linker unmodified.

For More Information:

- On the GLOBAL attribute (Section 10.2.17)
- On linking (*VSI Pascal for OpenVMS User Manual*)

10.2.45. WORD

The WORD attribute specifies the amount of storage in words to be received by the object.

```
WORD [[ ( n ) ]]
```

The optional constant n indicates the number of word storage units.

For More Information:

- On allocation sizes of objects (Section A.2.4)
- On size attribute restriction (Section 10.2.6)

10.2.46. WRITEONLY

The WRITEONLY attribute specifies that an object can have values assigned to it but cannot be read by a program.

Usage and Default Information:

- You can apply this attribute to variables, formal parameters, the base types of pointer variables, and components of structured variables.
- By default, objects can be both read and written.
- A write-only object cannot be used in expressions.
- A write-only component in an object of a structured type prohibits the object from being read.
- A write-only actual variable parameter can be passed only to a formal variable parameter that is write-only.
- A pointer expression whose base type is write-only is assignment compatible only with a pointer variable whose base type is write-only.

Consider the following example:

```
PROGRAM SAMPLE;  
TYPE  
    W_Only = [WRITEONLY] INTEGER;  
VAR  
    Writ_Int : W_Only;
```

```

Norm_Int : INTEGER;

PROCEDURE Try_Access( VAR Write_Param : W_Only ); EXTERNAL;

{In the executable section:}
Writ_Int := SQR( Norm_Int );
Try_Access( Writ_Int );

```

This example shows legal statements involving write-only variables. The write-only variable `Writ_Int` is assigned the result of the square root operation, and is then passed as an actual parameter to a write-only formal parameter.

For More Information:

- For information on the `READONLY` attribute (Section 10.2.34)

10.3. Attribute Classes

An attribute class can consist of a single attribute or of several attributes with a common characteristic. Table 10.7 lists the classes and their attributes.

Table 10.7. Attribute Classes

Class	Attributes	Description of Attributes
Alignment	ALIGN, ALIGNED, UNALIGNED	Indicate whether the object should be aligned on a specific address boundary in memory.
Allocation	AT, AUTOMATIC, COMMON, STATIC, PSECT	Indicate the form of storage that the object should occupy.
Asynchronous	ASYNCHRONOUS	Indicates that the routine can be called by an asynchronous event, such as a condition handler.
Check	CHECK	Indicates error-checking options to be enabled or disabled.
Double precision	FLOAT	Indicates the type of precision to use for objects of type <code>DOUBLE</code> .
Enumeration	ENUMERATION_SIZE	Indicates the sizes used for enumerated types and Boolean types.
Environment	ENVIRONMENT, PEN_CHECKING_STYLE	Indicate that VSI Pascal creates an environment file, which allows compilation units to share data definitions and declarations.
Hidden	HIDDEN	Indicates exclusion of a declaration or definition from a created environment file.
Ident	IDENT	Indicates the identification of a compilation unit to be passed to the linker.
Inherit	INHERIT	Indicates that the compilation unit can use the definitions and declarations

Class	Attributes	Description of Attributes
		specified in the inherited environment file.
Initialize	INITIALIZE	Indicates that the procedure is to be called before execution of the main program.
Key	KEY	Indicates key information for a record field that is used when accessing data in an indexed file.
List	LIST	Indicates that the routine can be called with actual parameter lists of various lengths.
Optimization	OPTIMIZE, NOOPTIMIZE	Indicate whether VSI Pascal should optimize code.
Parameter passing	CLASS_A, CLASS_NCA, CLASS_S, IMMEDIATE, REFERENCE	Indicate the passing mechanism to be used for a parameter.
Position	POS	Indicates that a record field should be forced to a specific bit position.
Read-only	READONLY	Indicates that the object can be read but cannot be written to.
Size	BIT, BYTE, WORD, LONG, QUAD, OCTA	Indicate the amount of storage to be reserved for the object.
Truncate	TRUNCATE	Indicates that the actual parameter list can be truncated at the position of this attribute in the formal parameter list.
Unbound	UNBOUND	Indicates that the routine does not access automatic variables outside its scope.
Unsafe	UNSAFE	Indicates that an object can accept values of any type without type checking.
Value	VALUE	Indicates that the variable is a reference to an external constant or is the defining point of a global constant.
Visibility	LOCAL, EXTERNAL, GLOBAL, WEAK_EXTERNAL, WEAK_GLOBAL	Indicate the ability of an object to be shared by compilation units.
Volatile	VOLATILE	Indicates that the value of an object can change at unusual points in program execution.
Write-only	WRITEONLY	Indicates that the object can be written to but cannot be read.

Some attributes are allowed to appear on routine declarations, routine parameters, and compilation units. Table 10.8 lists these attribute classes.

Table 10.8. Attributes on Routines and Compilation Units

Class	Program Element		
	Routine Parameter	Routine	Compilation Unit
Allocation	No	Yes ¹	Yes ¹
Asynchronous	Yes	Yes	No
Check	No	Yes	Yes
Double precision	No	No	Yes
Enumeration	No	No	Yes
Environment	No	No	Yes
Ident	No	No	Yes
Inherit	No	No	Yes
Initialize	No	Yes	No
List	Yes ²	No	No
Optimization	No	Yes	Yes
Truncate	Yes	No	No
Unbound	Yes	Yes	No
Visibility	No	Yes	Yes ³

¹PSECT is the only allocation attribute allowed.

²Allowed only on EXTERNAL routine definitions.

³EXTERNAL and WEAK_EXTERNAL are not allowed.

Attribute classes are allowed on various data items. Table 10.9 lists the classes that can be applied to various data items.

Table 10.9. Attributes on Data Items

Class	Data Item					
	Variable	Formal Parameter	Pointer Base Type	Component ¹	Function Result	Various Items ²
Alignment	Yes ³	Yes ⁴	Yes ⁴	Yes ⁵	Yes	No
Allocation	Yes ⁶	No	No	No	No	No
Hidden	Yes	No	Yes	No	No	No
Key	No	No	No	Yes ⁷	No	No
List	No	Yes ⁸	No	No	No	No
Parameter passing	No	Yes ⁹	No	No	No	No
Pos	No	No	No	Yes ⁷	No	No
Read-only	Yes	Yes	Yes	Yes	No	No
Size	Yes ⁶	Yes ¹⁰	Yes	Yes ¹¹	Yes	No
Truncate	No	Yes	No	No	No	No
Unsafe ⁶	Yes	Yes ⁹	Yes	Yes	Yes	Yes
Value	Yes ¹²	No	No	No	No	No
Visibility ⁶	Yes	No	No	No	No	No

Class	Data Item					
	Variable	Formal Parameter	Pointer Base Type	Component ¹	Function Result	Various Items ²
Volatile	Yes	Yes	Yes	Yes	Yes	No
Write-only	Yes	Yes	Yes	Yes	No	No

¹Component of a record, array, VARYING OF CHAR string, or file (includes conformant parameters).

²Index of an array, tag field of a variant record (when no tag identifier is present), base type of a set, formal discriminant.

³Variables of nonstatic types must be at least byte aligned.

⁴UNALIGNED not allowed.

⁵Not allowed on components of files or VARYING OF CHAR strings.

⁶Not allowed on variables of nonstatic types.

⁷Allowed only on record fields (including the tag field of a variant record).

⁸Procedure parameters and conformant parameters are allowed only on EXTERNAL routines.

⁹Not allowed on conformant VARYING parameters; not allowed on schematic parameters.

¹⁰Not allowed on conformant parameters; not allowed on schematic parameters.

¹¹Not allowed on components of files or VARYING OF CHAR strings, or on structured types with file components.

¹²Not allowed on variables larger than INTEGER or structured variables.

Chapter 11. Directives

Your source code can contain embedded directives, which will be evaluated at compile time. These directives can appear in any column and do not have to be on a line by themselves. You can use directives to control your compilation, and to extract immediate information at compile time.

The directives implemented in VSI Pascal are shown in the following table:

Directives	Section
%INCLUDE	11.1
%DICTIONARY	11.2
%TITLE and %SUBTITLE	11.3
%IF, %ELSE, %ELIF, and %ENDIF	11.4
%DEFINED	11.5
%ERROR, %WARN, %INFO, and %MESSAGE	11.6
%ARCH_NAME, %SYSTEM_NAME, and %SYSTEM_VERSION	11.7
%DATE, %TIME, and %COMPILER_VERSION	11.8
%LINE, %FILE, %ROUTINE, %MODULE, and %IDENT	11.9

11.1. %INCLUDE

%INCLUDE inserts the contents of a file at the location of the directive in the code and has the following form:

```
%INCLUDE 'file-spec [[/[NO]]LIST]'
```

file-spec

The name of the file to be included.

```
/[[NO]]LIST
```

The /LIST qualifier indicates that the included file should be printed in the listing of the program if a listing is being generated.

If you do not specify the /LIST qualifier, the default is determined by the use of compilation switches. Use of this parameter overrides compilation switches.

This directive can appear anywhere that a comment is legal.

In the following example, the %INCLUDE directive specifies the file CONDEF.PAS, which contains constant definitions:

In the Program:

```
PROGRAM Student_Courses( INPUT, OUTPUT, Sched );
```

```
CONST
  %INCLUDE 'CONDEF.PAS/LIST'
TYPE
  Schedules = RECORD
    Year      : ( Fr, So, Jr, Sr );
    Name      : PACKED ARRAY[1..30] OF CHAR;
    Parents   : PACKED ARRAY[1..40] OF CHAR;
    College   : ( Arts, Engineering, Architecture,
                 Agriculture, Hotel );
  END;
```

File CONDEF.PAS:

```
Max_Class = 300;
N_Profs   = 140;
Frosh     = 3000;
```

The main program `Student_Courses` is compiled as though it were written as follows:

```
PROGRAM Student_Courses( INPUT, OUTPUT, Sched );
CONST
  Max_Class = 300;
  N_Profs   = 140;
  Frosh     = 3000;
TYPE
  Schedules = RECORD
    Year      : ( Fr, So, Jr, Sr );
    Name      : PACKED ARRAY[1..30] OF CHAR;
    Parents   : PACKED ARRAY[1..40] OF CHAR;
    College   : ( Arts, Engineering, Architecture,
                 Agriculture, Hotel );
  END;
```

You can use the `%INCLUDE` directive in another included file; however, two files cannot attempt to include each other.

A file included at the outermost level of a program is said to be included at the first level. A file included by a first-level file is said to be included at the second level, and so on. In general, a program may not include any files beyond the fifth level; it may not include any files beyond the fourth level if you have included a `%DICTIONARY` directive in the fourth level. Nesting levels may be further restricted by the number of files you are allowed to have open at one time.

Figure 11.1 shows the legal levels of included files.

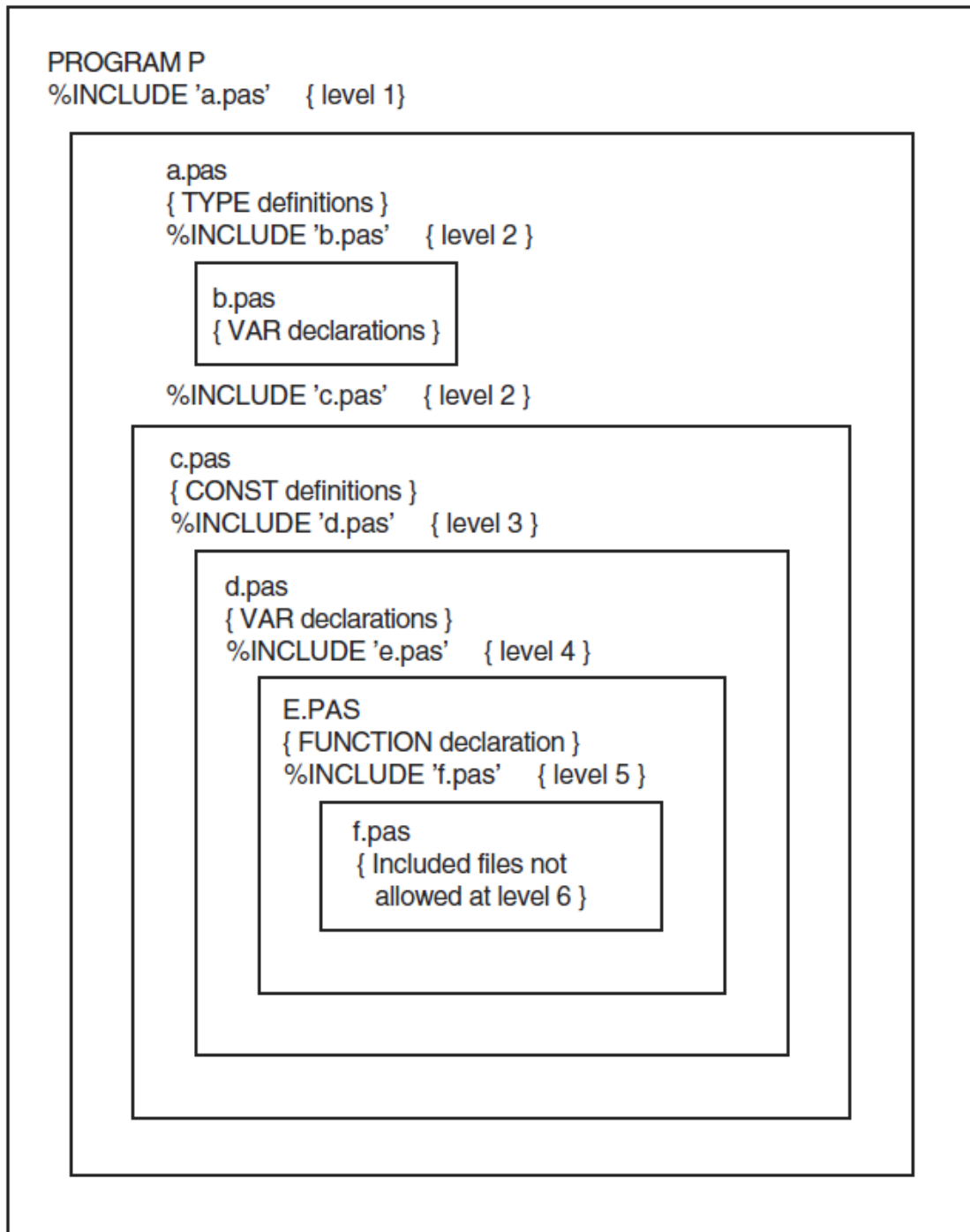
Figure 11.1. %INCLUDE File Levels

ZK-0285-GE

For More Information:

- On the Oracle CDD/Repository (CDD) (Section 11.2)
- On default file specifications and on including text libraries (*VSI Pascal for OpenVMS User Manual*)

11.2. %DICTIONARY

`%DICTIONARY` allows access to data definitions stored in the Oracle CDD/Repository (CDD), which is a product that must be purchased separately and may not be available on your environment; the directive has the following form:

```
%DICTIONARY 'cdd-path-name' [/[[[NO]]LIST]] '
```

`cdd-path-name`

A character string that represents the full or relative path name of a CDD record description to be extracted. The resulting path name must conform to the rules for forming CDD path names.

A full path name is one that begins with `CDD$TOP` and specifies the names of all its descendants; it is a complete path to the record definition. Descendant names are separated from each other by a period.

A relative path name begins with any generation other than `CDD$TOP`, and specifies the names of the descendants after that point. You can create a relative path by establishing a default directory with a logical name.

```
/[[NO]]LIST
```

Indicates that the included declarations should be printed in the listing of the program if a listing is being generated. If not specified, the default is determined by compilation switches. Use of this parameter overrides compilation switches.

For More Information:

- On using the Oracle CDD/Repository with VSI Pascal (*VSI Pascal for OpenVMS User Manual*)

11.3. %TITLE and %SUBTITLE

`%TITLE` and `%SUBTITLE` allow you to specify a compile-time string expression for the listing title and subtitle lines; they have the following form:

```
%TITLE 'character string'  
%SUBTITLE 'character string'
```

The compiler listing header includes the `%TITLE` and `%SUBTITLE` strings in the title and subtitle sections. If you do not specify these directives, VSI Pascal fills the `%TITLE` field with blanks and the first `%SUBTITLE` field with 'source listing'. If a specified character string is too long to fit in the predefined title and subtitle sections, the string will be truncated on the right without warning.

If a `%TITLE` directive appears on the first line of a page, it sets the title area for the current page and any following pages until the compiler encounters another `%TITLE` directive. If the `%TITLE` directive does not appear on the first line of a page, then the title area is not set until the next page.

The `%SUBTITLE` directive affects only the subtitle area in the source listing section. If a `%SUBTITLE` directive appears on the first or second line of a page, then the subtitle area is set for the current page. If the `%SUBTITLE` directive does not appear in the first two lines of a page, then the subtitle area is not set until the next page.

On OpenVMS VAX systems, if either of these directives is used and if a listing is being generated, VSI Pascal generates a table of contents page by default. It appears first in the listing, preceding the source listing section. To disable the table of contents option, you must use a compilation switch.

For More Information:

- On creating listings and on using compilation switches (*VSI Pascal for OpenVMS User Manual*)

11.4. %IF, %ELSE, %ELIF, and %ENDIF

The %IF family of directives is used to conditionally compile specified sections of source code. These directives are useful if you need to compile the same source code for various configurations or environments.

The %IF directive family has the following syntax:

```
%IF compile-time-expression
%THEN
    Pascal tokens . . .
[%ELIF compile-time-expression
%THEN
    Pascal tokens
    . . . ] . . .
[%ELSE
    Pascal tokens . . . ]
%ENDIF
```

A %IF directive can have zero or more %ELIF parts and zero or one %ELSE parts.

%IF directives can be nested up to 32 deep.

Note that skipped sections of source code must still be valid VSI Pascal tokens. The skipped tokens are not processed semantically by the compiler except for control expressions of nested %IF directives. All control expressions are semantically processed to ensure they result in a Boolean result. %INCLUDE and %DICTIONARY directives encountered while skipping tokens do not attempt to open the file name or access the dictionary path. Instead, they return the token TRUE.

In the following example, the state of a flag (Debug_Flag) is checked for true or false. The value of an integer variable (I) will then be set to either 12 or 1, depending on the state of the flag:

```
CONST
    Debug_Flag := true; { or false }
VAR
    I : integer;

I := %IF Debug_Flag %THEN 12 %ELSE 1 %ENDIF;
%IF Debug_Flag
%THEN
    writeln('Debug: the value of I is ',i:2);
%ENDIF
```

In the following example selected code will be compiled only if the specific configuration is selected.

```
TYPE
    Configs = (Config1, Config2, Config3);
CONST
    Config = Config1; { or Config2 or Config3 }

%IF Config = Config1
%THEN
```

```
    { Code for Config1... }

%ELIF Config = Config2
%THEN
    { Code for Config2... }

%ELSE Config = Config3
    { Code for Config3...}

%ENDIF
```

Note that the compile-time expression for the `%IF` statement is the same compile-time expression that can be used anywhere in VSI Pascal. You can use any operator or builtin routine in a `%IF` control expression, as you can in any constant expression.

One use of `%IF` is to compile for various configurations or environments (as shown in the preceding example).

Rather than defining a constant in the Pascal source as shown in the examples here, you might want to define the constant from the command line with the `/CONSTANT` qualifier. See the description of the `/CONSTANT` qualifier for more information.

11.5. %DEFINED

`%DEFINED` takes a name and returns `TRUE` if a name has a meaning in the current scope; otherwise, it returns `FALSE`. This is shown in the following example:

```
%IF %DEFINED(X)
%THEN
    writeln(x);
%ENDIF
```

11.6. %ERROR, %WARN, %INFO, and %MESSAGE

These directives will accept one or more string expressions, and at compile time will produce an error message, warning message, informational message, or terminal-only output (respectively).

The syntax is as follows:

```
%ERROR    ( string-expression, . . . )
%WARN     ( string-expression, . . . )
%INFO     ( string-expression, . . . )
%MESSAGE  ( string-expression, . . . )
```

The following is an example of `%ERROR`:

```
TYPE
    Some_Type = ...;

%IF SIZE(Some_Type) > 8
%THEN
    %ERROR ('We do not handle types greater than 8 bytes')
%ENDIF
```

The following is an example of %WARN:

```
%IF Config = Config1
%THEN
    { Code for Config1... }

%ELIF (Config = Config2) or (Config = Config3)
%THEN
    { Code for Config2/Config3... }

%ELSE
    %WARN ('Config not supported, defaulting to generic')
    { Code for generic config... }
%ENDIF
```

The following is an example of %INFO:

```
%IF Debug_Mode
%THEN
    %INFO('Building application with debug code inserted')
%ENDIF
```

The following is an example of %MESSAGE:

```
%IF DEBUG_MODE %THEN %MESSAGE ('Debug-mode is enabled') %ENDIF
```

11.7. %ARCH_NAME, %SYSTEM_NAME, and %SYSTEM_VERSION

%ARCH_NAME returns a string containing “IA64”, “Alpha”, or “VAX” depending on the architecture of the system on which the compilation is taking place.

%SYSTEM_NAME returns a string containing “OpenVMS.”

%SYSTEM_VERSION returns a string containing the value of SYI\$_VERSION from the \$GETSYI system-service.

For example:

```
program example(output);
begin
writeln('Program running on ', %system_name,
        ' ', %arch_name,
        ' ', %system_version);
end.
```

This example uses the %IF directive to selectively provide declarations or code based on the architecture:

```
%if %arch_name = "Alpha"
%then
    var handle : integer := 0;
%elif %arch_name = "IA64"
%then
    var handle : integer64 := 0;
%endif
```

11.8. %DATE, %TIME, and %COMPILER_VERSION

`%DATE` returns a string containing the date at the beginning point of the compilation.

`%TIME` returns a string containing the time at the beginning point of the compilation.

`%COMPILER_VERSION` returns a string containing the version string of the VSI Pascal compiler performing the compilation.

11.9. %LINE, %FILE, %ROUTINE, %MODULE, and %IDENT

`%LINE` returns an integer that denotes the current line number in the source file.

`%FILE` returns a string containing the file name that is currently being compiled. The string contains a full VSI OpenVMS file specification including the disk, directory, file name, file type, and version fields.

`%ROUTINE` returns a string with the name of the routine that is currently being compiled. If used in the executable portion of a program, the program's name is returned. If used in the declaration section of a `MODULE/PROGRAM`, the name of the `MODULE/PROGRAM` is returned.

`%MODULE` returns a string containing the name of the module/program that is currently being compiled.

`%IDENT` returns a string that contains the ident string of the compilation that is set with the `[IDENT()]` attribute.

Appendix A. Data Storage and Representation

This chapter describes how the VSI Pascal compiler allocates and represents program components. It discusses the following topics:

- Program sections (Section A.1)
- Storage allocation and alignment for variables (Section A.2)
- Internal representation of data types (Section A.3)

A.1. Program Sections

This chapter describes how to establish program sections and program section properties. The VSI Pascal compiler uses contiguous areas of memory, called **program sections**, to store information about a program.

The compiler writes these program sections to the object file. When constructing an executable image, the OpenVMS Linker divides the image into sections. Each image section contains program sections that have the same properties. The linker controls memory allocation by arranging image sections according to program section properties. You can use special linker options to change program section properties and to influence the memory allocation in the image. You include these options in a linker options file, which is input to the linker.

The OpenVMS Linker refers to the various characteristics of program sections as attributes. This chapter uses the term properties to avoid confusion with the VSI Pascal attribute classes.

Table A.1 lists the possible program section properties on VSI OpenVMS systems.

Table A.1. Program Section Properties

Property	Description
PIC/NOPIC	Position independent or position dependent
CON/OVR	Concatenated or overlaid
REL/ABS	Relocatable or absolute
GBL/LCL	Global or local scope
EXE/NOEXE	Executable or nonexecutable
RD/NORD	Readable or nonreadable
WRT/NOWRT	Writable or nonwritable
SHR/NOSHR	Shareable or nonshareable

For More Information:

- On program sections and linker options (*VSI OpenVMS Linker Utility Manual*)

A.1.1. Establishing Program Sections

Table A.2, Table A.3, and Table A.4 list the program sections that VSI Pascal can establish, if necessary, on VSI OpenVMS I64, VSI OpenVMS Alpha, and OpenVMS VAX systems, respectively.

Table A.2. Program Section Data on VSI OpenVMS I64 Systems

Program Section	Data
\$ABSS\$	No data is allocated in this program section. It is used for defining global literals (variables declared with the GLOBAL and VALUE attributes).
\$BSS\$	Zeroed static storage.
\$CODE\$ ¹	Machine instructions.
\$DATA\$	Nonexternal static types; writable variables declared with the STATIC attribute; writable variables that use default allocation and are declared at program or module level of a nonoverlaid compilation unit. All such variables must be larger than 64 bits in size.
LIB\$INITIALIZE	Addresses of routines declared with the INITIALIZE attribute and compiler-generated routines to perform module initialization.
\$LINK\$	Small literals.
\$LITERAL\$ ¹	Constants needing storage; nonvolatile, readonly, static variables.
\$SDATA\$	Nonexternal static types; writable variables declared with the STATIC attribute; writable variables that use default allocation and are declared at program or module level of a nonoverlaid compilation unit. All such variables must be 64 bits or smaller in size.

¹Executable code and read-only data are compiled into two separate program sections.

Table A.3. Program Section Data on VSI OpenVMS Alpha Systems

Program Section	Data
\$ABSS\$	No data is allocated in this program section. It is used for defining global literals (variables declared with the GLOBAL and VALUE attributes).
\$BSS\$	Zeroed static storage.
\$CODE\$ ¹	Machine instructions.
\$DATA\$	Nonexternal static types; writable variables declared with the STATIC attribute; writable variables that use default allocation and are declared at program or module level of a nonoverlaid compilation unit.
LIB\$INITIALIZE	Addresses of routines declared with the INITIALIZE attribute and compiler-generated routines to perform module initialization.
\$LINK\$	Procedure descriptors and small literals.
\$LITERAL\$ ¹	Constants needing storage; nonvolatile, readonly, static variables.

¹Executable code and read-only data are compiled into two separate program sections.

Table A.4. Program Section Data on OpenVMS VAX Systems

Program Section	Data
. ABS .	No data is allocated in this program section. It is used for defining global literals (variables declared with the GLOBAL and VALUE attributes).
\$CODE ¹	Machine instructions; constants needing storage; nonvolatile, readonly, static variables.
LIB\$INITIALIZE	Addresses of routines declared with the INITIALIZE attribute and compiler-generated routines to perform module initialization.

Program Section	Data
\$LOCAL	Nonexternal static types; writable variables declared with the <code>STATIC</code> attribute; writable variables that use default allocation and are declared at program or module level of a nonoverlaid compilation unit.
PAS\$GLOBAL	Writable variables that use default allocation and are declared at program or module level of an overlaid compilation unit.

¹On OpenVMS VAX systems, executable code and read-only data can exist in the same program section.

You can also establish user-defined program sections with the VSI Pascal `PSECT` and `COMMON` attributes. The `PSECT` attribute directs the compiler to establish a separate program section for static variables or executable blocks. In this way, you can ensure particular program section properties for these objects. You can also choose to group them with related static variables and blocks to reduce the amount of paging overhead.

The `COMMON` attribute directs the compiler to establish a particular program section called a common block. A common block is an overlaid program section that contains one variable. By storing variables in common blocks, a VSI Pascal program can share variables with programs written in other VSI languages.

The following example uses a common block to pass information between VSI Pascal and VSI Fortran:

VSI Pascal for OpenVMS Program:

```
PROGRAM Common_Example (OUTPUT);
VAR
  Myrec : [COMMON(Example)] RECORD
    Intfld : INTEGER;
    Strfld : PACKED ARRAY [1..10] OF CHAR;
  END;
[EXTERNAL] PROCEDURE Call_Fort; EXTERNAL;

BEGIN
Myrec := ZERO;
Call_Fort;
WRITELN('Intfld = ', Myrec.Intfld);
WRITELN('Strfld = ', Myrec.Strfld);
END.
```

VSI Fortran Subroutine:

```
      SUBROUTINE CALL_FORT
C
C   STRUCTURE /TEST/
      INTEGER*4 ITEM
      CHARACTER * 10 ITEM_NAME
C   END STRUCTURE
C
C   RECORD /TEST/ VAR
      COMMON /EXAMPLE/ VAR
C
      VAR.ITEM = 10
      VAR.ITEM_NAME = '0123456789'
C   END
```

The VSI Pascal program initializes the common record, `Myrec`, to zero, then calls the HP Fortran routine, `Call_Fort`, to assign the desired values to the elements within the common record. The VSI Pascal program then writes the assigned values to your terminal.

Only one variable can be allocated in a particular VSI Pascal common block. To share more than one data item in the same common block, the record variable containing all shareable items is declared and used.

For More Information:

- On the PSECT and COMMON attributes (Chapter 10)

A.1.2. Establishing Program Section Properties

Whether the compiler establishes a program section, or you create one, the program section is assigned one property from each class listed in Table A.1. These properties are assigned to satisfy the requirements of the types, variables, and executable blocks that have been allocated in the same program section. Table A.5 lists the minimal properties required by various objects.

Table A.5. Required Program Section Properties

Object	Properties			
	EXE	RD	WRT	NOSHR
Read-only variable		X		
Write-only variable		X	X	X ¹
Read/write variable		X	X	X ¹
Executable block ² (OpenVMS I64 and OpenVMS Alpha systems only)	X			
Executable block ² ("OpenVMS VAX systems only")	X	X		

¹This property is not assigned on OpenVMS VAX systems if the variable has the COMMON attribute.

²On VSI OpenVMS I64 and VSI OpenVMS Alpha systems, executable code and read-only data are compiled into two separate program sections; on OpenVMS VAX systems, executable code and read-only data can exist in the same program section.

The . ABS . and \$ABS\$ program section properties are ABS, NOEXE, NORD, NOWRT, and NOSHR. All other program sections except LIB\$INITIALIZE are position independent and relocatable; all except those established by the COMMON attribute are concatenated and local. Program sections established by COMMON are overlaid and global. The remaining properties are assigned as follows:

- The first time the compiler encounters the name of a particular program section (including a common block), it initializes the program section to be readable, nonwritable, shareable, and nonexecutable. Thus, the program section's initial properties are LCL, NOEXE, NOWRT, CON, PIC, RD, REL, and SHR.
- If storage for any writable object (except common blocks on OpenVMS VAX) is allocated in the same program section, the program section instantly becomes writable and nonshareable. Thus, the program section's write property changes from NOWRT to WRT, and its share property changes from SHR to NOSHR.
- On OpenVMS VAX, if storage for a writable object in a common block is allocated in the same program section, the program section becomes writable and retains the shareable property. Thus, the program section's write property changes from NOWRT to WRT, and its share property remains SHR.

If you want to guarantee that read-only variables can never be modified, you can allocate storage exclusively for them in a separate program section that will always remain nonwritable.

A.2. Storage Allocation

The following sections discuss storage allocation of variables, symbolic constants, and executable blocks. Static types require no allocation. Nonstatic data types require allocation to store possible run-time values. Section A.2.3 gives an example.

For More Information:

- On allocation for nonstatic data types (Section A.2.1)

A.2.1. Allocation of Variables

When allocating storage for a variable, the compiler first determines an allocation attribute for the variable. If the allocation attribute is `STATIC` or `COMMON`, the compiler then chooses a program section in which to allocate storage. The compiler applies the following rules sequentially to determine the allocation attribute:

- If the variable is declared with an allocation attribute, the attribute specifies the variable's allocation.
- If the variable is declared with a visibility attribute other than `LOCAL`, its allocation is static.
- If the variable is declared in a routine, its allocation is automatic.
- If the variable is declared at the outermost level of a module, its allocation is static.
- If the variable is declared at the outermost level of a program, the compiler must choose between static and automatic allocation. Whenever possible, the compiler uses automatic allocation for variables that are referred to only in the body of the main program because automatic allocation is more efficient. The compiler uses static allocation if the variable is declared with the `VOLATILE` attribute, initialized at its declaration, referred to in a nested block, or if the program has an `ENVIRONMENT` attribute. Because program-level variables can be statically allocated, VSI Pascal does not support recursive calls on the main program block.

The compiler applies the following rules sequentially to choose the program section in which to allocate storage for nonexternal common and static variables:

- If the variable has the `COMMON` attribute, storage is allocated in a common block that has either the same name as the variable, or the name specified by the identifier that accompanies the attribute.
- If the variable has the `PSECT` attribute, the identifier that accompanies the attribute supplies the name of the program section in which storage is to be allocated.
- If the variable does not have the `COMMON`, `PSECT`, or `STATIC` attribute, but is declared at the outermost level of an overlaid compilation unit, storage is allocated in the program section `PAS $GLOBAL`.
- If the variable has the `READONLY` attribute but does not have the `PSECT`, `COMMON`, or `VOLATILE` attributes:
 - On OpenVMS VAX systems, its storage is allocated in the program section in which storage for executable code is currently being allocated, by default, `$CODE`.
 - On all other systems, its storage is allocated in the program section `$LITERAL`.
- All other static variables are allocated in the program section `$LOCAL`.

For More Information:

- On attributes (Chapter 10)

A.2.2. Allocation of Symbolic Constants and Executable Blocks

When allocating storage for symbolic constants and executable blocks, the compiler determines the appropriate program section by applying the same rules of scope to program section names that it applies to identifiers. The compiler always allocates storage in the program section whose name appeared in the most recent heading of a routine or compilation unit.

Table A.3 and Table A.4 describe the program sections established for each kind of data in a program unless a PSECT attribute appears in the heading of routine or compilation unit and directs that storage to be allocated in a different program section.

For More Information:

- On the scope of VSI Pascal identifiers (Section 7.2)
- On the PSECT attribute (Section 10.2.32)
- On the INITIALIZE attribute (Section 10.2.22)
- On LIB\$INITIALIZE (*VSI OpenVMS Programming Concepts Manual*)

A.2.3. Allocation Example

Example A.1 shows how the compiler establishes program sections to allocate storage for symbolic constants, variables, and executable blocks. The comments in the programs indicate the names of the program sections used.

Example A.1. Using Program Sections to Allocate Storage

```
PROGRAM Allocate_Variables (INPUT,OUTPUT);

CONST
  Message_String = 'Random String Literal';    { $LITERAL on OpenVMS I64 }
                                                { $LITERAL on OpenVMS
Alpha }
                                                { $CODE on OpenVMS VAX }

VAR
  Magic_Number : [READONLY,PSECT(Magic)] INTEGER VALUE 42;
  { Magic }
  Local_Variable : INTEGER;                    { $SDATA$ on OpenVMS I64 }
                                                { $DATA$ on OpenVMS Alpha }
                                                { $LOCAL on OpenVMS VAX }

[PSECT(Error_Routines)] PROCEDURE User_Error;

  CONST
    User_Error_Message = 'Internal Error';    { Error_Routines }

  VAR
    Error_Count : [STATIC] INTEGER VALUE 0;  { $SDATA$ on OpenVMS I64 }
```

```

                                { $DATA$ on OpenVMS Alpha }
                                { $LOCAL on OpenVMS VAX }
    Message_Buffer : VARYING [132] OF CHAR; { Automatic Storage }
BEGIN { Error_Routines }
Error_Count := Error_Count + 1;
Local_Variable := Error_Count;
END;
BEGIN                                { $CODE or $CODE$ }
.
.
.
END.

```

Storage for all variables with static allocation is allocated in \$\$DATA\$, \$DATA\$, or \$LOCAL. Storage for the executable block of the main program is allocated in \$CODE or \$CODE\$. Storage for the symbolic constant Message_String is allocated in \$LITERAL on VSI OpenVMS I64 and VSI OpenVMS Alpha systems and in \$CODE on OpenVMS VAX systems. Storage is allocated in the user-created program section, Error_Routines, for the symbolic constant User_Error_Message and the executable block of User_Error. Storage for Local_Variable is in \$\$DATA\$ on VSI OpenVMS I64 systems, \$DATA\$ on VSI OpenVMS Alpha systems, and \$LOCAL on OpenVMS VAX systems because it was referred to in a nested block. Storage for Magic_Number is in the user-created program section, Magic. Since Magic_Number was declared with the READONLY attribute, the program section has the NOEXE, NOWRT, RD, and SHR properties.

A.2.4. Allocation Sizes of Variables

For every VSI Pascal data type, the compiler calculates the allocation size required when a variable of the type occurs in either an unpacked or a packed context. The unpacked size is always represented in bytes, while the packed size is represented in bits.

The packed size of a variable is the minimum number of bits required to represent all values of the variable's type. In general, the compiler uses the following 32-bit rules to determine the allocation size for a component of a packed structured variable:

- A component whose length is 32 bits or fewer is packed into as few bits as possible and can be unaligned.
- A component whose length is greater than 32 bits is allocated the smallest number of bytes possible and must be at least byte aligned.

If one of the size attributes (BIT, BYTE, WORD, LONG, QUAD, or OCTA) is applied to the variable, the size specified by the attribute represents the variable's packed size. Objects of floating point or pointer types must have a size equal to their allocation size. Ordinal types cannot exceed their maximum size, which is determined by the platform and the value of the data switch for the compile command. If no size attribute is applied to the variable, the compiler calculates the unpacked size so that it is structurally compatible with the base type of the variable's type.

Storage for variables of type VARYING OF CHAR is allocated as one byte per character, with an initial field of two bytes to indicate the total length. Storage allocation for a variable of type VARYING OF CHAR whose maximum length is less than or equal to 32 bits follows the 32-bit rules in that the variable can be unaligned. On VSI OpenVMS I64 and VSI OpenVMS Alpha systems, variables of type VARYING OF CHAR that need alignment are aligned on a word boundary.

On OpenVMS VAX systems, variables of type VARYING OF CHAR that need alignment are aligned on a byte boundary.

Structured objects (ARRAY and RECORD) take their maximum alignment from their components, for example, if the largest object is a word, the structure is aligned on a word boundary.

The maximum size for any variable is 2^{31-1} bits.

A.2.5. Storage Allocation of Types

Table A.6 shows the allocation size for variables of each type when the variables occur in either a packed or an unpacked context.

Table A.6. Storage Allocation of Types

Data Type	Unpacked Size in Bytes	Packed Size in Bits
INTEGER INTEGER32 UNSIGNED UNSIGNED32	4	32
INTEGER64 UNSIGNED64	8	64
CHAR	1	8
BOOLEAN	1 or 4^1	1
Enumerated ²	1, if 256 elements or fewer; 2, if more than 256 elements, or 4^1	$\log_2(\text{number of elements})^3 + 1$
Subrange	The size of the base type	If either the upper or lower bounds contain a reference to a formal discriminant, then the size of the base type, otherwise the minimum number in which the upper and lower bounds can be expressed ⁴
REAL or SINGLE	4	32
DOUBLE	8	64
QUADRUPLE	16	128
Pointer (OpenVMS I64 and OpenVMS Alpha systems only)	4 or 8^5	32 or 64^5
Pointer (OpenVMS VAX systems only)	4	32
Unpacked ARRAY	The sum of the unpacked sizes in bytes of all components, plus the sum of the sizes in bytes of any holes created to meet alignment requirements	Unpacked size in bytes * 8
Unpacked RECORD	The sum of the unpacked sizes in bytes of the fields in the fixed part and the largest variant, plus the sum of the sizes in bytes of any holes created to meet alignment requirements	Unpacked size in bytes * 8

Data Type	Unpacked Size in Bytes	Packed Size in Bits
PACKED ARRAY	The sum of the packed sizes in bits of all components, plus the sum of sizes in bits of any holes created to meet alignment requirements; this sum is rounded up to a multiple of 8 and then divided by 8	The sum of the packed sizes in bits of all components, plus the sum of sizes in bits of any holes created to meet alignment requirements; if the sum is greater than 32, the sum is rounded up to the next multiple of 8
PACKED RECORD	The sum of the packed sizes in bits of all fields in the fixed part and the largest variant, plus the sum of sizes in bits of any holes created to meet alignment requirements; this sum is rounded up to a multiple of 8 and then divided by 8	The sum of the packed sizes in bits of all fields in the fixed part and the largest variant, plus the sum of sizes in bits of any holes created to meet alignment requirements; if the sum is greater than 32, the sum is rounded up to the next multiple of 8
STRING, VARYING OF CHAR	Maximum length + 2	(Maximum length + 2) * 8
Nonstatic PACKED SET, Unpacked SET ³	32, if the set base type is a subrange of INTEGER or UNSIGNED; else, compute (ORD(upper-bound of ordinal type that is base type of set's base type) + 8) DIV 8, and if this result is less than or equal to 8, the result is rounded up to 1, 2, 4, or 8	Compute (ORD (upper-bound) + 1); if the result is less than or equal to 64, the result is rounded up to 8, 16, 32, or 64, and if the result is greater than 64, the result is rounded to next higher multiple of 8
PACKED SET ³	The result of (ORD(upper-bound) + 8) DIV 8	Compute (ORD (upper-bound) + 1); if the result is greater than 32, the result is rounded to next higher multiple of 8
FILE	Not specified	Not specified

¹It depends on the value specified for the /ENUMERATION_SIZE qualifier.

²The maximum number of elements is 65,535.

³This is known as the ceiling function, where the smallest integer is greater than or equal to X.

⁴Sets of type INTEGER and UNSIGNED are limited to 256 bits.

⁵By default, pointers on VSI OpenVMS I64 and VSI OpenVMS Alpha systems are 32 bits in size. However, the QUAD attribute can be used on pointer declarations to specify 64-bit pointers. See the *VSI Pascal for OpenVMS User Manual* for more information.

The formula to compute the size of a packed subrange is $\text{MAX}(X, Y) + Z$ where X, Y, and Z are computed as follows (LOW represents the low bound of the subrange; HIGH represents the upper bound):

```

IF LOW < -1
THEN
  X := log2(-LOW - 1) + 1
ELSE
  X := 0;

IF HIGH > 0
THEN
  Y := log2(HIGH) + 1
ELSE
  Y := 0;

IF LOW >= 0
THEN
  Z := 0
ELSE

```

```
Z := 1;
```

You can discover both the unpacked and packed sizes for variables of any type by using the predeclared functions `BITNEXT`, `BITSIZE`, `NEXT`, and `SIZE`, which require a parameter that is the name of either a type or a variable. These functions return the following integer values:

- `BITNEXT` returns an integer value that indicates what the packed size would be for an array component of the type.
- `BITSIZE` returns an integer value that indicates what the packed size would be for a record field of the type.
- `NEXT` returns an integer value that indicates what the unpacked size would be for an array component of the type.
- `SIZE` returns an integer value that indicates what the unpacked size would be for a variable or record field of the type.

The maximum size for any variable is 2^{31-1} bits.

For More Information:

- On size attributes (Chapter 10)
- On predeclared functions (Chapter 8)

A.2.6. Allocation Size Examples

The following examples show the effects of packing records and multidimensional arrays at various levels.

Note

Although packing records and arrays does save storage space and can be necessary for compatibility with other code, note that accessing unaligned variables on an VSI OpenVMS I64 or VSI OpenVMS Alpha system takes many more instructions than accessing variables with natural alignment, such as those in unpacked records and arrays.

Example 1

```
TYPE
  Internal_Arr = ARRAY[1..5] of 0..6;

VAR
  Samp1_Arr : PACKED ARRAY[1..5] OF Internal_Arr;
```

Each component of an array of type `Internal_Arr` is stored in a longword. Each component of `Samp1_Arr`, in turn, requires five longwords, which is enough storage space for five components of type `Internal_Arr`. The entire array `Samp1_Arr` occupies 25 longwords (800 bits).

Example 2

```
VAR
  Samp1_Arr : ARRAY[1..5] OF PACKED ARRAY[1..5] OF 0..6;
```

Each PACKED ARRAY[1..5] of 0..6 requires 15 bits (the range 0..6 requires 3 bits; five 3-bit components requires 15 bits). Because the packed arrays are components of an unpacked array, their size is rounded up to an even 16 bits. The total size of Samp1_Arr is 80 bits.

Example 3

```
TYPE
    Internal_Arr = PACKED ARRAY[1..5] OF 0..6;

VAR
    Samp2_Arr : PACKED ARRAY[1..5] OF Internal_Arr;
    Samp3_Arr : PACKED ARRAY[1..5,1..5] OF 0..6;
```

In this example, every component of Internal_Arr requires only three bits because the array is packed. Each component of Samp2_Arr and Samp3_Arr can be stored in 15 bits, and each array occupies 75 bits. The specification of PACKED for an array with multiple indexes results in packing at every level. The two arrays in this example are equivalent.

Example 4

```
VAR
    Sample : PACKED ARRAY[1..5,1..5,1..5] OF 0..6;
```

This example shows space savings for arrays of more than two dimensions when PACKED is specified at every level. The subrange 0..6 requires 3 bits; five 3-bit components require 15 bits. This size describes the innermost dimension of Sample. Next, five 15-bit components require 75 bits. Because of the 32-bit rules, each 75-bit component is rounded up to 80 bits. This size describes the middle and inner dimensions of Sample. Finally, five 80-bit components require 400 bits (50 bytes). The entire array Sample then requires 400 bits.

Example 5

```
VAR
    Sample_Rec : PACKED RECORD
        Field_1 : BOOLEAN;
        Field_2 : INTEGER32;
        Field_3 : DOUBLE;
    END;
```

In this example, Field_1 requires only 1 bit of storage. Field_2 is 32 bits in size (declared as INTEGER32) and starts immediately following Field_1. Because Field_3 is larger than 32 bits, it will start on the next byte boundary. The entire record Sample_Rec, therefore, requires 104 bits.

A.2.7. Alignment Boundaries

The memory-addressing boundary on which a variable or a component is aligned depends on the variable's or the component's allocation size. You can change the alignment by using the ALIGNED and UNALIGNED attributes. Table A.7 lists the conditions that determine boundary alignment.

Table A.7. Conditions Determining Boundary Alignment

Object	Arguments to the Alignment Switch	
	NATURAL ¹	VAX
Variable declared with an alignment attribute	Specified alignment	Specified alignment

Object	Arguments to the Alignment Switch	
	NATURAL ¹	VAX
Variable declared without an alignment attribute	Natural alignment	Byte alignment ²
Component of an unpacked array or record variable	Natural alignment	Byte alignment
Component of a packed array or record variable	Follows the 32-bit rules ³	Follows the 32-bit rules ⁴
Dynamic variables allocated by the NEW procedure	Octaword alignment on OpenVMS I64; quadword alignment on OpenVMS Alpha	Quadword alignment

¹Previous versions of VSI Pascal used ALPHA_AXP for this keyword. The NATURAL keyword is now the recommended spelling for the same behavior. The ALPHA_AXP keyword will continue to be recognized for compatibility with old source files.

²The compiler can align such variables on a larger storage boundary if it can access them more efficiently by doing so.

³If a variable of type VARYING OF CHAR on an VSI OpenVMS I64 or VSI OpenVMS Alpha system requires alignment, it is aligned on a word boundary.

⁴If a variable of type VARYING OF CHAR on an OpenVMS VAX system requires alignment, it is aligned on a byte boundary.

You can save storage space by packing variables of structured types, but you must be careful to pack at the proper level. Except for its alignment, a record field whose type is an unpacked array, set, or record occupies the same amount of space in a packed or an unpacked record variable. To pack such a field, you must explicitly declare its type to be packed.

When packing multidimensional arrays, you must specify packing at the innermost level to gain any significant space advantage. For example, there is no advantage in packing an array of an unpacked structured type; the unpacked components will still be aligned on byte boundaries, which leaves holes in the storage space. To gain storage space, you must specify a packed array of a packed structured type.

The following examples show the use of alignment boundaries.

Note

Although packing records and arrays does save storage space and can be necessary for compatibility with other code, note that accessing unaligned variables on an VSI OpenVMS I64 or VSI OpenVMS Alpha system takes many more instructions than accessing variables with natural alignment, such as those in unpacked records and arrays.

Example 1

```
VAR
  X : [STATIC, ALIGNED(3)] INTEGER; { QUADWORD ALIGNED }
                                     { $SDATA$ on OpenVMS I64 }
                                     { $DATA$ on OpenVMS Alpha }
                                     { $LOCAL on OpenVMS VAX }
```

In this example, X is declared a static variable that is aligned on a QUADWORD boundary.

Example 2

```
VAR
  X : PACKED RECORD { AUTOMATIC }
      Field1 : BOOLEAN;
      Field2 : REAL;
      Field3 : BOOLEAN;
      Field4 : DOUBLE;
  END;
```

In this example, Field1 begins at bit position 0 and is 1 bit long. Field2 begins at bit position 1 and is 32 bits long. Field3 begins at bit position 33 and is 1 bit long. However, because Field4 is greater than 32 bits long (DOUBLE requires 64 bits) Field4 must be byte aligned. For this reason, Field4 begins on bit position 40 and is 64 bits long.

Example 3

```
VAR
  X : RECORD { AUTOMATIC }
      Field1 : [BIT(3)] 0..7;
      Field2 : [UNALIGNED] INTEGER32;
  END;
```

In this example, Field1 of record X is declared to begin on bit position 0 and is 3 bits long. Due to the use of the UNALIGNED attribute on Field2, Field2 begins on bit position 3 and is 32 bits long. You can obtain the same behavior by packing record X.

Without using the UNALIGNED attribute, or without X being a PACKED record, Field2 would have been longword aligned; that is, it would have started on bit position 32. You cannot use the UNALIGNED attribute with INTEGER64 because of the 32-bit rules, which states that variables greater than 32 bits must be at least byte-aligned.

For More Information:

- On ranges and precision of integer and real types (Chapter 2)
- On the representation of data types (Section A.3)
- On the 32-bit rules (Section A.2.4)
- On the ALIGNED and UNALIGNED attributes (Chapter 10)

A.3. Internal Representation of Data Types

The following sections summarize the internal representation of the VSI Pascal data types.

A.3.1. Representation of Varying Data

This section summarizes the internal representation of VARYING OF CHAR types. A variable of type VARYING OF CHAR is stored as though it were an VSI Pascal record type of the following form:

```
RECORD
  Length : [WORD] 0..Maxlength;
  Body   : PACKED ARRAY[1..Maxlength] OF CHAR;
END;
```

Figure A.1 shows the storage allocated for a variable of type VARYING[8] OF CHAR.

Figure A.1. Storage of Varying Data

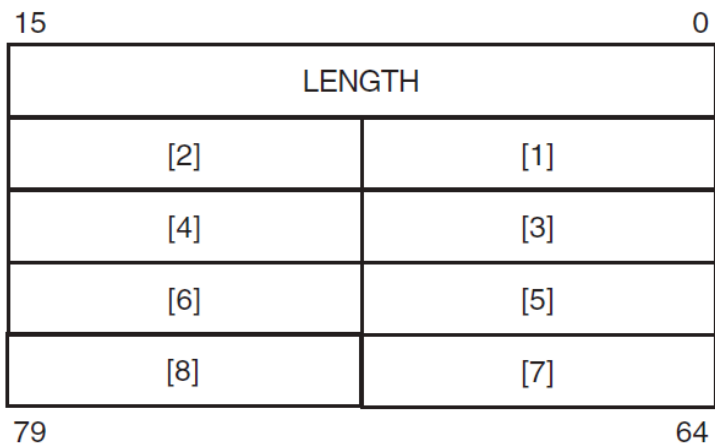

ZK-1038-GE

The predefined schema type STRING uses VARYING OF CHAR as its underlying data type, so Figure A.1 also represents the STRING type.

For More Information:

- On VSI Pascal varying data types (Section 2.6.2)
- On the UNALIGNED attribute (Section 10.2.38)
- On VSI Pascal string data types (Section 2.6)

A.3.2. Representation of Floating-Point Data

The following sections summarize the internal representation of single-precision (F_floating and S_floating), double-precision (D_floating, G_floating, and T_floating), and quadruple-precision (H_floating and X_floating) floating-point numbers.

For More Information:

- On VSI Pascal floating-point data types (Section 2.2)

A.3.2.1. F_floating-Point Numbers

An F_floating-point value is represented by four contiguous bytes. The bits are numbered from the right, 0 through 31, as shown in Figure A.2.

Figure A.2. F_floating-Point Data Representation

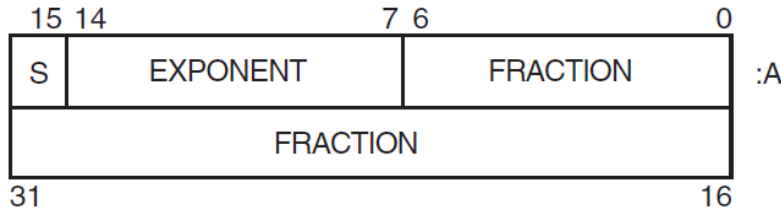

ZK-1039-GE

An F_floating-point value is specified by its address A, the address of the byte containing bit 0. The form of this value is sign magnitude as follows:

- Bit 15 is the sign bit.
- Bits 14 through 7 are an excess 128 binary exponent.
- Bits 6 through 0 and 31 through 16 are a normalized 24-bit fraction with the redundant most significant fraction bit not represented. Within the fraction, bits of increasing significance go from 16 through 31 and from 0 through 6.

For More Information:

- On F_floating-point range and precision (Section 2.2)

A.3.2.2. S_floating-Point Numbers

An S_floating-point value is represented by four contiguous bytes. The bits are numbered from the right, 0 through 31, as shown in Figure A.3.

Figure A.3. S_floating-Point Data Representation

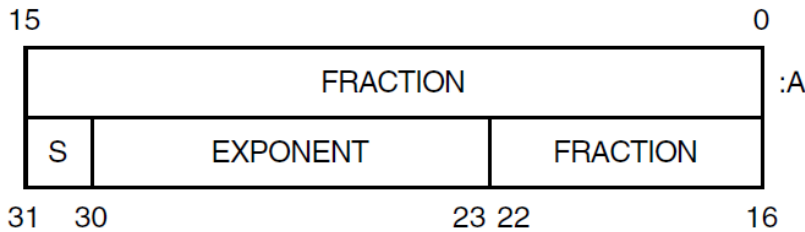

ZK-4977A-GE

An S_floating-point value is specified by its address A, the address of the byte containing bit 0. The form of this value is sign magnitude as follows:

- Bit 31 is the sign bit (0 for positive numbers, 1 for negative numbers).
- Bits 30 through 23 are an excess 127 exponent.

- Bits 22 through 0 are a normalized 24-bit fraction with the redundant most significant fraction bit not represented.

For More Information:

- On S_floating-point range and precision (Section 2.2)

A.3.2.3. D_floating-Point Numbers

A D_floating-point value is represented by eight contiguous bytes. The bits are numbered from the right, 0 through 63, as shown in Figure A.4.

Figure A.4. D_floating-Point Data Representation

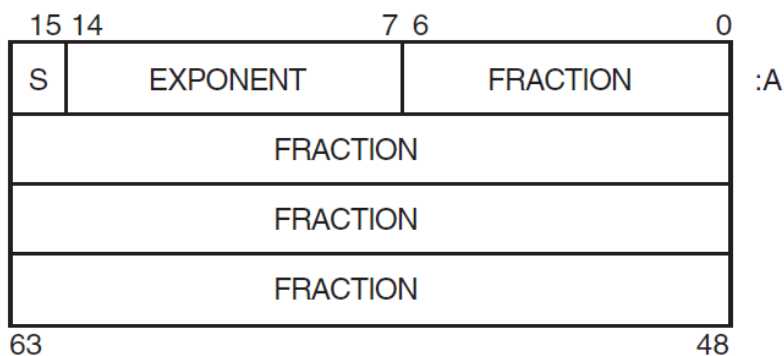

ZK-1040-GE

A D_floating-point value is specified by its address A, the address of the byte containing bit 0. The form of this value is identical to that of a F_floating-point value except for an additional 32 low-significance fraction bits. Within the fraction, bits of increasing significance are numbered 48 through 63, 32 through 47, 16 through 31, and 0 through 6.

For More Information:

- On D_floating-point range and precision (Section 2.2)

A.3.2.4. G_floating-Point Numbers

A G_floating-point value is represented by eight contiguous bytes. The bits are numbered from the right, 0 through 63, as shown in Figure A.5.

Figure A.5. G_floating-Point Data Representation

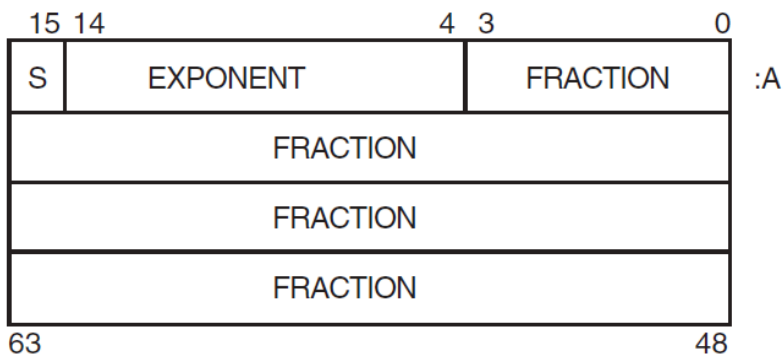

ZK-1041-GE

A G_floating-point value is specified by its address A, the address of the byte containing bit 0. The form of this value is sign magnitude as follows:

- Bit 15 is the sign bit.
- Bits 14 through 4 are an excess 1024 binary exponent.
- Bits 3 through 0 and 63 through 16 represent a normalized 53-bit fraction without the redundant most significant fraction bit. Within the fraction, bits of increasing significance go from 48 through 63, 32 through 47, 16 through 31, and 0 through 3.

For More Information:

- On G_floating-point range and precision (Section 2.2)

A.3.2.5. T_floating-Point Numbers

A T_floating-point value is represented by 8 contiguous bytes. The bits are numbered from the right 0 through 63, as shown in Figure A.6.

Figure A.6. T_floating-Point Data Representation

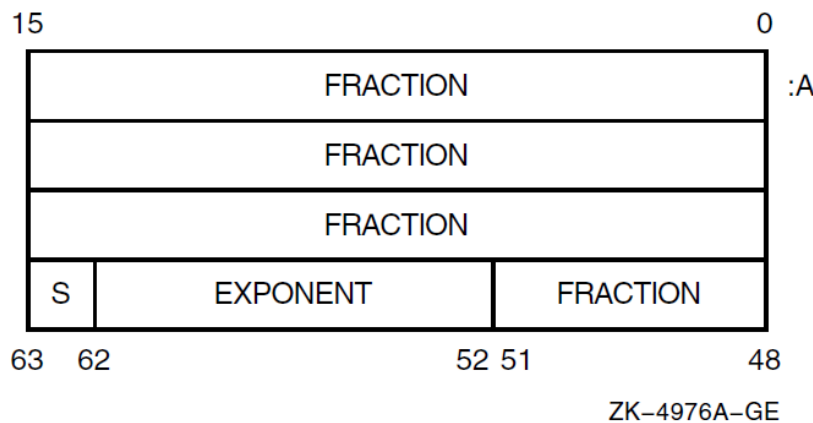

A T_floating-point value is specified by its address A, the address of the byte containing bit 0. The form of this value is sign magnitude as follows:

- Bit 63 is the sign bit (0 for positive numbers, 1 for negative numbers).
- Bits 62 through 52 are an excess 127 exponent.
- Bits 51 through 0 are a normalized 53-bit fraction with the redundant most significant fraction bit not represented.

For More Information:

- On T_floating-point range and precision (Section 2.2)

A.3.2.6. H_floating-Point Numbers

An H_floating-point value is represented by 16 contiguous bytes. The bits are numbered from the right 0 through 127, as shown in Figure A.7.

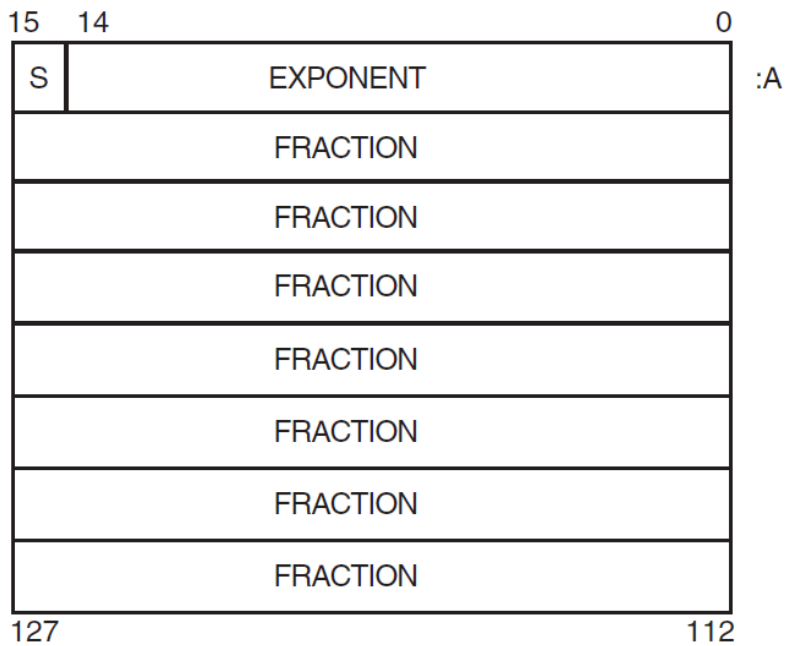
Figure A.7. H_floating-Point Data Representation

ZK-1042-GE

An H_floating-point value is specified by its address A, the address of the byte containing bit 0. The form of this value is sign magnitude as follows:

- Bit 15 is the sign bit.
- Bits 14 through 0 are an excess 16,384 binary exponent.
- Bits 127 through 16 are a normalized 113-bit fraction with the redundant most significant fraction bit not represented. Within the fraction, bits of increasing significance go from 112 through 127, 96 through 111, 80 through 95, 64 through 79, 48 through 63, 32 through 47, and 16 through 31.

For More Information:

- On H_floating-point range and precision (Section 2.2)

A.3.2.7. X_floating-Point Numbers

An X_floating-point value is represented by 16 contiguous bytes. The bits are numbered from the right 0 through 127, as shown in Figure A.8.

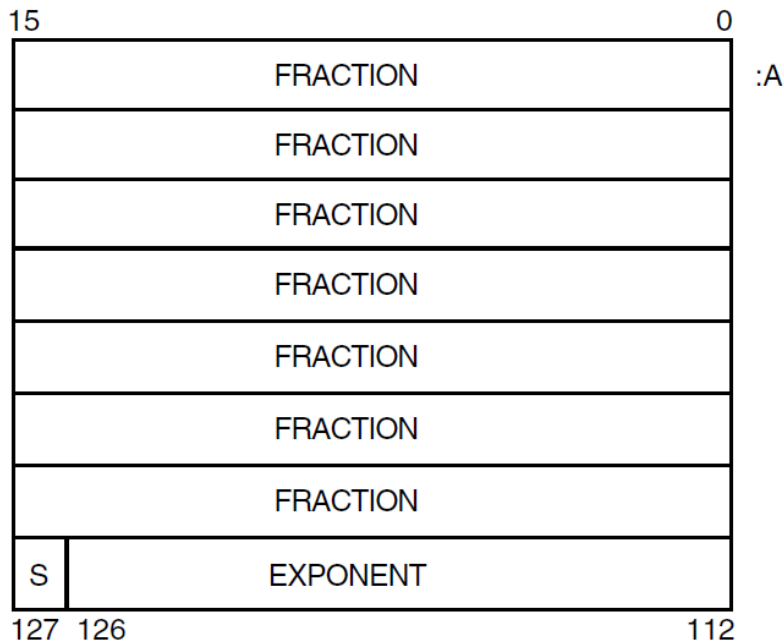
Figure A.8. X_floating-Point Data Representation

ZK-8078A-GE

An X_floating-point value is specified by its address A, the address of the byte containing bit 0. The form of this value is sign magnitude as follows:

- Bit 127 is the sign bit.
- Bits 112 through 126 are an excess 16,383 binary exponent.
- Bits 0 through 111 are a normalized 112-bit fraction with the redundant most significant fraction bit not represented.

For More Information:

- On X_floating-point range and precision (Section 2.2)

A.3.3. Representation of Nonstatic Types and Variables

This section describes the representation of nonstatic types and variables.

A.3.3.1. Representation of Nonstatic Types

Each nonstatic data type has some storage associated with it, called the control part. Figure A.9 shows the layout of a control part of a nonstatic data type.

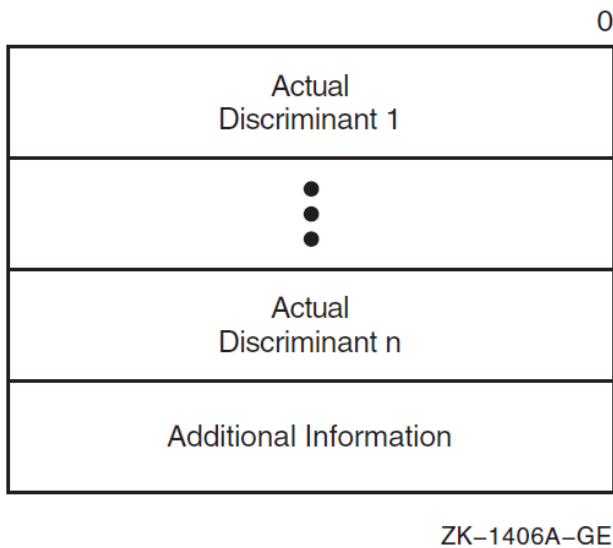
Figure A.9. Storage of Nonstatic Data Types

In the top portion of the control part, VSI Pascal stores each actual discriminant of the schema type in a longword of storage. The additional information piece of the control part varies in content and size depending on the type specification, and can contain any of the following:

- No information (if the schema type is simple), as follows:

```
TYPE
  A_Char( x, y : CHAR ) = x..y;
```

- Control parts of nested discriminated schema types, as follows:

```
TYPE
  My_Record( a, b : INTEGER ) = RECORD
    f1 : STRING( a );
    f2 : STRING( b );
  END;
```

- Values for all expressions appearing in the type definition, as follows:

```
TYPE
  My_Subrange( a, b : INTEGER ) = a..a+b;
```

VSI Pascal evaluates the expression $a+b$ when the schema type is discriminated and saves the result in the control part.

- The total size of the data part, if it can vary based on actual discriminants, as follows:

```
TYPE
  Arr( a, b : INTEGER ) = ARRAY[a..b] OF REAL;
```

Note

The order of information and the content of the additional information section of the control part cannot be guaranteed.

If you declare more than one variable of a discriminated schema type, each variable shares the information in the control part for that type.

A.3.3.2. Representation of Variables of Nonstatic Types

When allocating storage for a variable of a nonstatic type, VSI Pascal allocates a pointer part and a data part. VSI Pascal allocates and initializes the pointer part (to point to the data part); you cannot access the pointer part in your program. VSI Pascal associates each object with a control part according to its data type.

If the type of the object involves more than one nonstatic type, VSI Pascal associates that object with all applicable control parts. Consider the following example:

```
TYPE
  Sub_Range( a, b : INTEGER ) = a..b;

VAR {x requires information in two control parts:}
  x : ARRAY[Sub_Range( i, j ), Sub_Range( k, l )] OF INTEGER;
```

Figure A.10 shows the layout for an object of a nonstatic type.

Figure A.10. Storage of Variables of Nonstatic Types

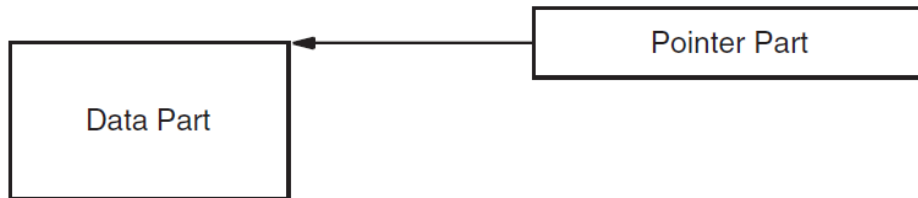

ZK-1407A-GE

In Figure A.10, the pointer part is directly accessible by your program. The data part is allocated in heap when you use the NEW procedure. For example:

```
TYPE
  dstr = STRING( I );

VAR
  ptr : ^dstr;
{In the executable section:}
NEW( ptr );
```

You cannot create variables of undiscriminated types, but you can also show the representation for pointers to nonstatic types (except undiscriminated schema).

Figure A.11 shows the layout for a pointer to an undiscriminated schema type.

Figure A.11. Storage of Pointer Variables to Undiscriminated Schema Types

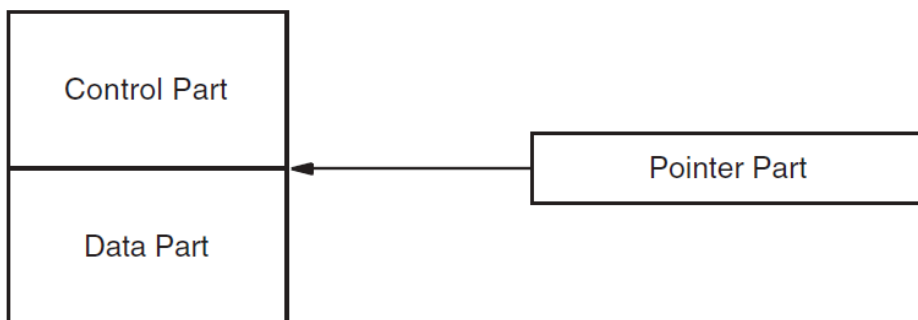

ZK-1408A-GE

In Figure A.11, the control part and data part are allocated together by a call to the NEW procedure. Each object allocated this way has its own control part since the base type of the pointer is undiscriminated and does not have a control part. Consider the following example:

```
VAR
    x, y, z : ^STRING;
{In the executable section:}
NEW( x, 10 );    {x has a control and data part}
y := x;         {y points to same control and data part as x}
NEW( z, 10 );   {z has separate control and data parts}
```

Each variable created by NEW contains a unique control part attached to the data part.

A.3.3.3. Representation of Nonstatic Record Fields

If a record object contains a field of a nonstatic type, VSI Pascal stores the field in one piece of storage within the record's storage (VSI Pascal does not create a pointer part and a data part). VSI Pascal determines the offset of the object by accessing the information in the control part of the field's data type and information in the control part of the record.

Appendix B. Summary of VSI Pascal for OpenVMS Extensions

If you need to write portable code, you should not use the language features that are VSI Pascal extensions. The following sections provide information on VSI Pascal extensions:

- Extensions to the unextended Pascal standards (Section B.1)
- Extensions to the Extended Pascal standard (Section B.2)

For More Information:

- On Pascal standards (Section 1.1)

B.1. VSI Pascal for OpenVMS Extensions to Unextended Pascal

Table B.1 summarizes the language features provided in VSI Pascal that are not part of the unextended Pascal language definitions.

Table B.1. VSI Pascal for OpenVMS Extensions to Unextended Pascal

Category	Extension
Lexical and syntactical extensions	Reserved words: BREAK, CONTINUE, ERR, EXIT, MODULE, NEXT, OTHERWISE, REM, RETURN, VALUE, VARYING, %DESCR, %STDESCR, %IMMED, %REF, %INCLUDE, %TITLE, %SUBTITLE, %DICTIONARY, %IF, %ELIF, %ENDIF, %DEFINED, %ERROR, %WARN, %INFO, %MESSAGE, %ARCH_NAME, %SYSTEM_NAME, %SYSTEM_VERSION, %DATE, %TIME, %COMPILER_VERSION, %LINE, %FILE, %ROUTINE, %MODULE, %IDENT
	Exponentiation operator (**)
	REM operator
	AND_THEN and OR_ELSE operators
	NOT IN operator
	Type cast operator (::) for variables and expressions
	Double quotation marks as string and character delimiters
	Escape sequences within double quotation marks
	%radix-specifier for binary, hexadecimal, and octal notation for integers, (#) radix-specifier for integers in bases 2 to 36 inclusive
	Double- and quadruple-precision real numbers
	Dollar sign (\$) and underscore (_) characters in identifiers
	Identifiers that can begin with the dollar sign or underscore characters
	Alphanumeric strings for labels
	Extended syntax for inclusion of nonprinting characters in single-quoted character strings

Category	Extension
	<p>Compile-time constant expressions allowed anywhere a constant is allowed</p> <p>Constructors of structured types used anywhere in place of a constant of the structured type</p> <p>Attributes used with data items, routines, and compilation units</p> <p>Relaxed rules for assignment compatibility</p> <p>Structural compatibility enforced between actual and formal parameters</p> <p>! for end-of-line comments</p>
Predefined types	<p>ALFA, CARDINAL, CARDINAL16, C_STR_T, INTEGER_ADDRESS, CARDINAL32, INTEGER8, INTEGER16, INTEGER32, INTEGER64, INTSET, POINTER, UNIV_PTR, UNSIGNED8, UNSIGNED16, UNSIGNED32, UNSIGNED64, SINGLE (F_floating and S_floating), DOUBLE (D_floating, G_floating, and T_floating), QUADRUPLE (H_floating and X_floating), STRING, TIMESTAMP</p> <p>VARYING OF CHAR structured type and concatenation operator for all strings</p>
Predeclared procedures	<p>ARGV, ASSERT, BARRIER, CLOSE, CREATE_DIRECTORY, DATE, DELETE, DELETE_FILE, ESTABLISH, EXTEND, FIND, FINDK, GETTIMESTAMP, HALT, LINELIMIT, LOCATE, OPEN, READV, REMOVE, RENAME_FILE, RESETK, REVERT, STLIMIT, TIME, TRUNCATE, UNLOCK, UPDATE, WRITEV GETTIMESTAMP</p>
Predeclared functions	<p>Transfer functions: DBLE, INT, INT64, QUAD, ROUND64, SNGL, TRUNC, TRUNC64, UINT, UINT64, UROUND, UROUND64, UTRUNC, UTRUNC64</p> <p>Implicitly declared type-conversion and type-casting routines for predefined data types</p> <p>Dynamic allocation function: ADDR, ADDRESS, IADDRESS, IADDRESS64</p> <p>Character-string functions: BIN, DEC, HEX, INDEX, LENGTH, OCT, PAD, STATUSV, SUBSTR, UDEC, GT, GE, LT, LG, EQ, NE</p> <p>Parameter functions: ARGUMENT, ARGUMENT_LIST_LENGTH, PRESENT</p> <p>Privileged routines: MFPR, MTPR</p> <p>Arithmetic functions: BITAND, BITNOT, BITOR, BITXOR, LSHFT, LSHIFT, MIN, MAX, RANDOM, RSHFT, RSHIFT, SEED, UAND, UNOT, UOR, UXOR, XOR</p> <p>Allocation size functions: SIZE, SIZEOF, NEXT, BITSIZE, BITNEXT</p> <p>Ordered sequence of values functions: FIRST, FIRSTOF, HBOUND, IN_RANGE, LAST, LASTOF, LBOUND</p> <p>Low-level interlocked functions: ADD_ATOMIC, ADD_INTERLOCKED, AND_ATOMIC, CLEAR_INTERLOCKED, FIND_FIRST_BIT_CLEAR, FIND_FIRST_BIT_SET, FIND_MEMBER, FIND_NONMEMBER, OR_ATOMIC, SET_INTERLOCKED</p> <p>Null-terminated string functions: C_STR, MALLOC_C_STR, PAS_STR, PAS_STRCPY</p>

Category	Extension
	I/O functions: STATUS, UFB
	Field position functions: BIT_OFFSET, BYTE_OFFSET
	Additional functions: ARGC, CARD, CLOCK, EXPO, UNDEFINED, ZERO, DATE, TIME, UPPER, LOWER, SYSCLOCK, WALLCLOCK
READ, READLN, WRITE, WRITELN extensions	Parameters of character-string and enumerated types for READ and READLN Parameters of enumerated types for WRITE and WRITELN Prompting at the terminal with a WRITE/READ or WRITE/READLN sequence Optional carriage-control specification for text files with WRITE and WRITELN Optional radix specification for READ and READLN Optional radix specification for WRITE and WRITELN
Extended I/O capabilities	Direct access and relative file organization Keyed access and indexed file organization Optional second parameter to RESET, REWRITE, and EXTEND for specifying a file name
Declarations	Declaration and definition sections that can appear more than once and in any order Initialization of variables, types, and record fields in VAR and TYPE sections of any program, module, procedure, or function Schema types VALUE initialization section OTHERWISE clause in variant records Ranges in variant label lists
Statements	OTHERWISE clause in CASE statement Ranges in CASE label lists BREAK, CONTINUE, EXIT, NEXT, and RETURN statements FOR statement with SET iterations
Procedures and functions	Functions that return values of structured types (other than file types) Functions called as procedures External procedure and function declarations Default values for formal parameters Nonpositional parameter passing Extended mechanism specifiers and parameter-passing attributes for passing parameters to external procedures and functions: %IMMED, %REF, %DESCR, %STDESCR, IMMEDIATE, REFERENCE, CLASS_S, CLASS_A, CLASS_NCA

Category	Extension
Compilation	MODULE capability for combining declarations and definitions to be compiled independently from the main program
	ENVIRONMENT and INHERIT attributes to control independent compilation
	Module initialization and finalization

B.2. VSI Pascal for OpenVMS Extensions to Extended Pascal

Table B.2 summarizes the language features provided in VSI Pascal that are not part of the Extended Pascal language definitions.

Table B.2. VSI Pascal for OpenVMS Extensions to Extended Pascal

Category	Extension
Lexical and syntactical extensions	Reserved words: BREAK, CONTINUE, ERR, EXIT, NEXT, REM, RETURN, VARYING, %DESCR, %STDESCR, %IMMED, %REF, %INCLUDE, %TITLE, %SUBTITLE, %DICTIONARY, %DICTIONARY, %IF, %ELIF, %ENDIF, %DEFINED, %ERROR, %WARN, %INFO, %MESSAGE, %ARCH_NAME, %SYSTEM_NAME, %SYSTEM_VERSION, %DATE, %TIME, %COMPILER_VERSION, %LINE, %FILE, %ROUTINE, %MODULE, %IDENT
	REM operator
	NOT IN operator
	Type cast operator (::) for variables and expressions
	"%radix-specifier number" form for binary, hexadecimal, and octal notation for integers
	Alphanumeric strings for labels
	Double- and quadruple-precision real numbers
	Identifiers can contain the dollar sign (\$) character
	Identifiers can begin with the dollar sign character and the underscore character
	Double quotation marks as string and character delimiters
	Escape sequences within double quotation marks
	Labels can be alphanumeric strings
	Extended syntax for inclusion of nonprinting characters in single-quoted character strings
	Parenthetical form ((constructor)) for constructors of structured types, used anywhere in place of a constant of the structured type
	Attributes
	Relaxed rules for assignment compatibility
	Structural compatibility enforced between actual and formal parameters

Category	Extension
	! for end-of-line comments
Predefined types	ALFA, C_STR_T, CARDINAL, CARDINAL16, CARDINAL32, INTEGER8, INTEGER16, INTEGER32, INTEGER64, INTSET, POINTER, UNIV_PTR, UNSIGNED8, UNSIGNED16, UNSIGNED32, UNSIGNED64, SINGLE (F_floating and S_floating), DOUBLE (D_floating, G_floating, and T_floating), QUADRUPLE (H_floating and X_floating) VARYING OF CHAR structured type and concatenation operator for all strings
Predeclared procedures	ARGV, ASSERT, BARRIER, CLOSE, CREATE_DIRECTORY, DATE, DELETE, DELETE_FILE, ESTABLISH, FIND, FINDK, LINELIMIT, LOCATE, NULL, OPEN, READV, REMOVE, RENAME_FILE, RESETK, REVERT, STLIMIT, TIME, TRUNCATE, UNLOCK, UPDATE, WRITEV
Predeclared functions	Transfer functions: DBLE, INT, INT64, QUAD, ROUND64, SNGL, TRUNC, TRUNC64, UINT, UINT64, UROUND, UROUND64, UTRUNC, UTRUNC64 Implicitly declared type-conversion and type-casting routines for predefined data types Dynamic allocation function: ADDR, ADDRESS, IADDRESS, IADDRESS64 Character-string functions: BIN, DEC, HEX, OCT, PAD, STATUSV, UDEC Parameter functions: ARGUMENT, ARGUMENT_LIST_LENGTH, PRESENT Arithmetic functions: BITAND, BITNOT, BITOR, BITXOR, LSHFT, LSHIFT, RANDOM, RSHFT, RSHIFT, SEED, UAND, UNOT, UOR, UXOR, XOR, MIN, MAX Allocation size functions: SIZE, SIZEOF, NEXT, BITSIZE, BITNEXT Ordered sequence of values functions: FIRST, FIRSTOF, HBOUND, IN_RANGE, LAST, LASTOF, LBOUND Low-level interlocked functions: ADD_ATOMIC, ADD_INTERLOCKED, AND_ATOMIC, CLEAR_INTERLOCKED, FIND_FIRST_BIT_CLEAR, FIND_FIRST_BIT_SET, FIND_MEMBER, FIND_NONMEMBER, OR_ATOMIC, SET_INTERLOCKED Privileged routines: MTPR, MFPR I/O functions: STATUS, UFB Null-terminated string functions: C_STR, MALLOC_C_STR, PAS_STR, PAS_STRCPY Field position functions: BIT_OFFSET, BYTE_OFFSET Additional predeclared functions: ARGV, CLOCK, EXPO, LOWER, SYSCLOCK, UNDEFINED, UPPER, WALLCLOCK, ZERO
READ, READLN, WRITE, WRITELN extensions	Parameters of enumerated types for READ and READLN Parameters of enumerated types for WRITE and WRITELN

Category	Extension
	<p>Prompting at the terminal with a WRITE/READ or WRITE/READLN sequence</p> <p>Optional carriage-control specification for text files with WRITE and WRITELN</p> <p>Optional radix specification for READ and READLN</p> <p>Optional radix specification for WRITE and WRITELN</p>
Extended I/O capabilities	<p>Direct access and relative file organization</p> <p>Keyed access and indexed file organization</p> <p>Optional second parameter to RESET, REWRITE, and EXTEND for specifying a file name</p>
Declarations	VALUE initialization section
Statements	BREAK, CONTINUE, EXIT, NEXT, and RETURN statements
Procedures and functions	<p>Functions called as procedures</p> <p>External procedure and function declarations</p> <p>Default values for formal parameters</p> <p>Nonpositional parameter passing</p> <p>Extended mechanism specifiers and parameter-passing attributes for passing parameters to external procedures and functions: %IMMED, %REF, %DESCR, %STDESCR, IMMEDIATE, REFERENCE, CLASS_S, CLASS_A, CLASS_NCA</p>
Compilation	MODULE syntax differs from the syntax provided by Extended Pascal
	ENVIRONMENT and INHERIT attributes to control independent compilation

Appendix C. Description of Implementation Features

The standards for Pascal allow some features of the language to be defined by a particular implementation or to be dependent on an implementation.

This appendix describes the VSI Pascal Treatment: of the following features:

- Section C.1: Implementation-Defined Features
- Section C.2: Implementation-Dependent Features

For More Information:

On Pascal standards (Section 1.1)

C.1. Implementation-Defined Features

The value of each character allowed in a character string

Treatment: See Section 1.2.1.

The range of real number values represented by the type REAL

Treatment: See Section 2.2.

The characters represented by the type CHAR and their ordinal values

Treatment: See Section 1.2.1.

The point at which the REWRITE, PUT, RESET, and GET procedures are performed on a file

Treatment: Performed immediately unless the file is a terminal file, in which case delayed device access occurs (see Section 9.5.3).

The value of MAXINT

Treatment: See Table 2.2

The accuracy to which the results of real-number operations are calculated

Treatment: See Table 2.6.

Default field widths

Treatment: See Section 9.6.

The number of digits used to represent the exponent of a floating-point, number**Treatment:**

REAL, SINGLE (F_floating and IEEE S floating-point format)	2
DOUBLE (D_floating)	2
DOUBLE (G_floating and IEEE T floating point-format)	3
QUADRUPLE (H_floating and X_floating)	4

The value of the exponent character**Explanation:** 'E'.**The case (upper or lower) in which the Boolean values TRUE and FALSE are printed as output****Explanation:** Uppercase; that is, TRUE and FALSE.**The effect of the PAGE procedure****Treatment:** PAGE writes a line containing only the form-feed character (ASCII value 12).

C.2. Implementation-Dependent Features

The unextended Pascal standard and the Extended Pascal standard list features that can vary from implementation to implementation. It is illegal for a program to depend on these features. VSI Pascal does not detect when a program depends on any of these features. Relying on them may yield incorrect results or unexpected program terminations.

Any or all of these implementation-dependent features may change without notice.

For those items in this section that pertain to order of evaluation, VSI Pascal does not specify the order of evaluation. Depending on several heuristics in the compiler, the order of evaluation can be left-to-right, right-to-left, or random with complete or short-circuit evaluation. The order of evaluation is allowed to vary between invocations of the compiler and even between individual uses of source language features.

The order of evaluation of the following items:

- Expressions used as discriminant values
- Index expressions and access to the array or string variable in a indexed variable
- Index values of an array variable
- Expressions d_1, \dots, d_n in $\text{new}(p, d_1, \dots, d_n)$
- Expressions of a set member designator
- Set member designators in a set constructor
- Operands of a dyadic (binary) operator, except for AND_THEN and OR_ELSE
- Component values of a structured value constructor
- Index expressions in an indexed constant
- Expressions in a set constructor

Treatment: Random order.

Order of selecting members of the set value in the FOR IN statement

Treatment: Random order.

Whether the first character read when reading an integer or real from a text file is the value of the buffer variable or the value of the next character from the input record

Treatment: VSI Pascal uses the next character in the input record and ignores the contents of the file buffer.

Order of evaluating, and accessing of actual parameters of a function call

Treatment: Random order.

Order of evaluating, and accessing of actual parameters of a procedure call

Treatment: Random order.

Order of accessing the variable and evaluating the expression in an assignment statement

Treatment: Random order.

The effect of reading a text file for which the PAGE procedure was called

Treatment: Reads a line containing only the form-feed character (ASCII value 12).

The binding of a nonfile variable whose name is listed in the program heading to entities that are external to the program

Treatment: Reported as an error at compile time.

The binding of a file variable whose name is listed in the program heading

The file name (unless it is INPUT or OUTPUT) is equated to a logical name if a translation for the file name exists. If there is no corresponding translation, the file type DAT is appended to the name listed in the heading, as in INFILE.DAT. If the file name is INPUT, the file is equated to PASS\$INPUT, if PASS\$INPUT is defined; otherwise, the file is equated to SYS\$INPUT. Similarly, if the file name is OUTPUT, the file is equated to PASS\$OUTPUT, if PASS\$OUTPUT is defined; otherwise, the file is equated to SYS\$OUTPUT.

Appendix D. Compiler and Run-Time System Error Detection

This appendix describes how the VSI Pascal compiler and run-time system detect violations of the Pascal language standards. Errors detected at run-time cause a program to terminate and return appropriate error messages. Errors described here as not detected cause a program to produce unexpected results.

For More Information:

- On Pascal standards (Section 1.1)
- On VSI Pascal error messages (*VSI Pascal for OpenVMS User Manual*)

D.1. Error Message Information

The type of an index value is not assignment compatible with the index type of an array.

Detected at run time if bounds checking was enabled during compilation.

The current variant changes while a reference to it exists.

Not detected. An example of a reference to a variant is the passing of the variant to a formal VAR parameter.

The value of a variable to which a pointer refers (p[^]) is NIL.

Usually detected at run time. Always detected if pointers checking was enabled during compilation.

The value of a variable to which a pointer refers (p[^]) is undefined.

Not detected.

The DISPOSE procedure is called to dispose of a heap-allocated variable while a reference to the variable exists.

Not detected. Examples of such references are passing the variable, or a component of it, to a formal VAR parameter, or using the variable in a WITH statement (if the variable is a record).

The value of file f changes while a reference to f[^] exists.

Not detected. An example of a reference to f[^] is the passing of f[^] by reference to a routine; until the routine has ceased execution, you cannot perform any operation on file f.

The ordinal type of an actual parameter is not assignment compatible with the type of the corresponding formal parameter.

Detected at run time if subrange checking was enabled during compilation of the called routine.

The set type of an actual parameter is not assignment compatible with the type of the corresponding formal parameter.

Detected at run time if subrange checking was enabled during compilation of the called routine.

A file is not in generation mode when a PUT, WRITE, WRITELN, or PAGE procedure is attempted.

Detected at run time.

A file is in undefined mode when a PUT, WRITE, WRITELN, or PAGE procedure is attempted.

Not detected.

The result of an EOF function is not TRUE when a PUT, WRITE, WRITELN, or PAGE procedure is attempted.

Detected at run time. The operation is illegal only when the file is accessed sequentially.

The value of the file buffer variable is undefined when a PUT procedure is attempted.

Not detected.

A file is in undefined mode when a RESET procedure is attempted.

Not detected.

A file is not in inspection mode when a GET, READ, or READLN procedure is attempted.

Detected at run time.

A file is in undefined mode when a GET, READ, or READLN procedure is attempted.

Not detected.

The result of an EOF function is TRUE when a GET, READ, or READLN procedure is attempted.

Detected at run time.

The type of the file buffer variable is not assignment compatible with the type of the variable that is a parameter to a READ or READLN procedure.

Detected at run time.

The type of the expression being written by a WRITE or WRITELN procedure is not assignment compatible with the type of the file buffer variable.

Detected at run time.

The current variant does not exist in the list of variants specified with the NEW procedure.

Not detected.

The DISPOSE(p) procedure is called to deallocate a pointer variable that was created using the variant form of the NEW procedure.

Not detected.

The variant form of the DISPOSE procedure does not specify the disposal of the same number of variants that were created by the variant form of the NEW procedure.

Not detected.

The variant form of the DISPOSE procedure does not specify the disposal of the same variants that were created by the variant form of the NEW procedure.

Not detected.

The value of the parameter to the DISPOSE procedure is NIL.

Detected at run time.

The value of the parameter to the DISPOSE procedure is undefined.

Not detected.

A variant record created by the NEW procedure is accessed as a whole, rather than one component at a time.

Not detected.

In the PACK(a,i,z) procedure, the type of the index value i is not assignment compatible with the index type of a.

Detected at run time if subrange checking was enabled during compilation.

The PACK procedure is attempted when the value of at least one component of a is undefined.

Not detected.

The index value i in the PACK procedure is greater than the upper bound of the index type of a .

Detected at run time if subrange checking was enabled during compilation.

In the UNPACK(z,i,a) procedure, the type of the index value i is not assignment compatible with the index type of a .

Detected at run time if subrange checking was enabled during compilation.

The UNPACK procedure is attempted when the value of at least one component of z is undefined.

Not detected.

The index value i in the UNPACK procedure is greater than the upper bound of the index type of a .

Detected at run time if subrange checking was enabled during compilation.

The resulting value of SQR(x) does not exist.

Detected at run time for integers if overflow checking was enabled during compilation; always detected at run time for real numbers.

In the expression LN(x), the value of x is negative.

Detected at run time.

In the expression SQRT(x), the value of x is negative.

Detected at run time.

The resulting value of TRUNC(x) does not exist after the following calculations have been done: if the value of x is positive or zero, then $0 \leq x - \text{TRUNC}(x) < 1$; otherwise, $-1 < x - \text{TRUNC}(x) \leq 0$.

Detected at run time if overflow checking was enabled during compilation.

The resulting value of ROUND(x) does not exist after the following calculations have been done: if the value of x is positive or zero, then ROUND(x) is equivalent to TRUNC($x + 0.5$); otherwise, ROUND(x) is equivalent to TRUNC($x - 0.5$).

Detected at run time if overflow checking was enabled during compilation.

The resulting value of CHR(x) does not exist.

Detected at run time if subrange checking was enabled during compilation.

The resulting value of SUCC(x) does not exist.

Detected at run time if subrange checking was enabled during compilation.

The resulting value of PRED(x) does not exist.

Detected at run time if subrange checking was enabled during compilation.

The function EOF(f) is called when the file f is undefined.

Not detected.

The function EOLN(f) is called when the file f is undefined.

Not detected.

The function EOLN(f) is called when the result of EOF(f) is TRUE.

Not detected.

A variable is not initialized before it is first used.

Not detected.

In the expression x/y, the value of y is zero.

Detected at run time.

In the expression i DIV j, the value of j is zero.

Detected at run time.

In the expression i MOD j, the value of j is zero or negative.

Detected at run time if subrange checking was enabled during compilation.

An operation or function involving integers does not conform to the mathematical rules for integer arithmetic.

Detected at run time if overflow checking was enabled during compilation.

A function result is undefined when the function returns control to the calling block.

Not detected.

The ordinal type of an expression is not assignment compatible with the type of the variable or function identifier to which it is assigned.

Detected at run time if subrange checking was enabled during compilation.

The set type of an expression is not assignment compatible with the type of the variable or function identifier to which it is assigned.

Detected at run time if subrange checking was enabled during compilation.

None of the case labels is equal in value to the case selector in a CASE statement.

Detected at run time if case selector checking was enabled during compilation.

In a FOR statement, the type of the initial value is not assignment compatible with the type of the control variable, and the statement in the loop body is executed.

Detected at run time if subrange checking was enabled during compilation. Assignment compatibility is not enforced if the statement in the loop body can never be executed.

In a FOR statement, the type of the final value is not assignment compatible with the type of the control variable and the statement in the loop body is executed.

Detected at run time if subrange checking was enabled during compilation. Assignment compatibility is not enforced if the statement in the loop body can never be executed.

When an integer is being read from a text file, the digits read do not constitute a valid integer value. (Initial spaces and end-of-line markers are skipped.)

Detected at run time.

When an integer is being read from a text file, the type of the value read is not assignment compatible with the type of the variable.

Detected at run time if subrange checking was enabled during compilation.

When reading a real number from a text file, the digits read do not constitute a valid real number. (Initial spaces and end-of-line markers are skipped.)

Detected at run time.

The value of the file buffer variable is undefined when a READ or READLN procedure is performed.

Not detected.

A WRITE or WRITELN procedure specifies a field width in which the integers representing the total width and the number of fractional digits are less than 1.

Not detected.

The bounds of an array passed to a conformant array parameter are outside the range specified by the conformant array's index type.

Detected at run time if bounds checking was enabled during compilation.

